



General Purpose US Fuses

American Power Fuses TRI-ONIC® TR and TRS (Class RK5 TD)



The industry's Most popular fuse for Motor circuit protection.

Tri-onic® SmartSpot® fuses now provide a visual open fuse indicator. With advanced material technology added to the existing product the TR and TRS current limiting time delay fuses are engineered for overcurrent protection of motors and transformers, service entrance equipment, feeder and branch circuits. Tri-onic proven time delay characteristic safely handles harmless starting currents and inrush currents associated with today's motors and transformers.

Features/Benefits

- Solid State SmartSpot Indicator
- Time delay for motor start-ups and transformer inrush currents without nuisance opening
- Current limiting for low peak let-thru current
- Rejection-style design prevents replacement errors (when used with recommended fuse blocks)
- Easy-to-read label for quick recognition and replacement
- Metal-embossed date and catalog number for traceability and lasting identification
- Fiberglass body provides dimensional stability in harsh industrial settings
- Brass end-caps (blade-style) for cooler operation and superior performance
- High-grade silica filler ensures fast arc quenching and high current limitation

Ratings

TR

AC: 1/10 to 600A 250VAC, 200kA I.R.

DC: 1/10 to 2 8/10A and 35 to 400A, 250VD, 20 A.I.R
3 to 30A & 450 to 600A,
160VDC, 20kA I.R.

TRS

AC: 1/10 to 600A, 600VAC, 200kA I.R.

DC: 1/10 to 12A, 600VDC, 20kA I.R.
70 to 600A, 600VDC, 100kA I.R.
15 to 60A, 300VDC, 20kA I.R.

Highlights

- Time Delay
- Current Limiting
- AC & DC Rated

Applications

- Motor Circuits
- Mains
- Feeders
- Branch Circuits
- Transformers
- Service Entrance Equipment
- General-purpose Protection

Approvals

- UL Listed to Standard 248-12
- CSA Certified to Standard C22.2 No. 248.12
- DC Listed to UL Standard 198L



General Purpose US Fuses



American Power Fuses

TRI-ONIC®

TR and TRS (Class RK5 TD)

Standard Fuse Ampere Ratings

Ampere Rating	Catalog Number		Reference Number		Ampere Rating	Catalog Number		Reference Number	
	250V	600V	250V	600V		250V	600V	250V	600V
1/10	TR1/10R	TRS1/10R	F222530	W216748	10	TR10R	TRS10R	D200839	N218811
15/100	TR15/100R	TRS15/100R	E201898	F223059	12	TR12R	TRS12R	S201381	B219858
2/10	TR2/10R	TRS2/10R	Z214198	X216749	15	TR15R	TRS15R	D211120	B201389
3/10	TR3/10R	TRS3/10R	C217260	J212160	17-1/2	TR17-1/2R	TRS17-1/2R	S211639	K211126
4/10	TR4/10R	TRS4/10R	Z223053	Y216750	20	TR20R	TRS20R	D214708	P217777
1/2	TR1/2R	TRS1/2R	Y223052	N217776	25	TR25R	TRS25R	G215217	B219329
6/10	TR6/10R	TRS6/10R	R216238	L213197	30	TR30R	TRS30R	F217769	K213196
8/10	TR8/10R	TRS8/10R	T219322	R217779	35	TR35R	TRS35R	F218804	J214207
1	TR1R	TRS1R	Z212151	H212159	40	TR40R	TRS40R	E200840	Q217778
1-1/8	TR1-1/8R	TRS1-1/8R	Q218284	G212158	45	TR45R	TRS45R	F201899	Q218813
1-1/4	TR1-1/4R	TRS1-1/4R	E217768	J211125	50	TR50R	TRS50R	B213188	D201391
1-4/10	TR1-4/10R	TRS1-4/10R	E218803	H213194	60	TR60R	TRS60R	P216742	M214716
1-6/10	TR1-6/10R	TRS1-6/10R	R219320	G214205	70	TR70R	TRS70R	Q219848	Y213691
1-8/10	TR1-8/10R	TRS1-8/10R	S219850	R215732	75	TR75R	TRS75R	E222529	P215730
2	TR2R	TRS2R	J215725	Q222539	80	TR80R	TRS80R	W223050	W216242
2-1/4	TR2-1/4R	TRS2-1/4R	A213187	H214206	90	TR90R	TRS90R	B200837	L217774
2-1/2	TR2-1/2R	TRS2-1/2R	Q212672	J213195	100	TR100R	TRS100R	K216738	D214202
2-8/10	TR2-8/10R	TRS2-8/10R	S213686	S215733	110	TR110R	TRS110R	B218800	K215220
3	TR3R	TRS3R	T219851	P215224	125	TR125R	TRS125R	N219317	N215729
3-2/10	TR3-2/10R	TRS3-2/10R	N216741	N201906	150	TR150R	TRS150R	P219847	S216745
3-1/2	TR3-1/2R	TRS3-1/2R	Q216237	M200847	175	TR175R	TRS175R	D222528	K217773
4	TR4R	TRS4R	A212152	D219860	200	TR200R	TRS200R	V223049	K218808
4-1/2	TR4-1/2R	TRS4-1/2R	G222531	A216246	225	TR225R	TRS225R	A200836	Y219855
5	TR5R	TRS5R	E214709	M211128	250	TR250R	TRS250R	P201378	L222535
5-6/10	TR5-6/10R	TRS5-6/10R	R212673	H223061	300	TR300R	TRS300R	B201895	J200844
6	TR6R	TRS6R	S218286	V215735	350	TR350R	TRS350R	A211117	J201902
6-1/4	TR6-1/4R	TRS6-1/4R	S218286	K212161	400	TR400R	TRS400R	P211636	G211123
7	TR7R	TRS7R	G218805	Z216751	450	TR450R	TRS450R	N218282	E212156
8	TR8R	TRS8R	V219852	R218814	500	TR500R	TRS500R	C218801	W212677
9	TR9R	TRS9R	H222532	S222541	600	TR600R	TRS600R	P219318	F213192

Note: Indicator not available (1/10-7) Amps

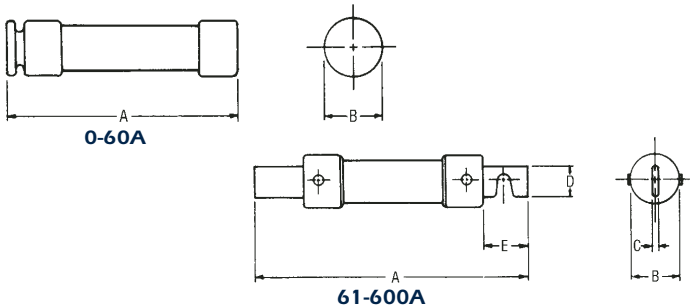

Recommended Fuse Blocks With Box Connectors For Tri-onic® Class RK5 Fuses

Fuse Ampere Rating	Catalog Number		Ref. Number	
	250V		250V	
	1 Pole	3 pole	1 pole	3 pole
0-30	20306R	20308R	T213411	K215956
31-60	20606R	20608R	B212383	E214939
61-100	21036R	21038R	D201621	M212899
101-200	22001R	22003R	R213915	G214941
201-400	24001R	24003R	J219566	D222022
401-600	2631R	2633R	H214942	P215960

Dimensions

Ampere Rating	A		B		C		D		E	
	In.	mm	In.	mm	In.	mm	In.	mm	In.	mm

250V-TR Fuses

0-30	2	51	9/16	14	-	-	-	-	-	-
31-60	3	76	13/16	21	-	-	-	-	-	-
61-100	5-7/8	149	1-1/16	27	1/8	3	3/4	19	1	25
101-200	7-1/8	181	1-9/16	40	3/16	5	1-1/8	28	1-3/8	35
201-400	8-5/8	219	2-1/16	53	1/4	6	1-5/8	41	1-7/8	48
401-600	10-3/8	264	2-9/16	66	1/4	6	2	51	2-1/4	57

600V-TRS Fuses

0-30	5	127	13/16	21	-	-	-	-	-	-
31-60	5-1/2	139	1-1/16	27	-	-	-	-	-	-
61-100	7-7/8	200	1-5/16	34	1/8	3	3/4	19	1	25
101-200	9-5/8	244	1-13/16	46	3/16	5	1-1/8	28	1-3/8	35
201-400	11-5/8	295	2-9/16	66	1/4	6	1-5/8	41	1-7/8	48
401-600	13-3/8	340	3-1/8	80	1/4	6	2	51	2-1/4	57

Fuse Ampere Rating	Catalog Number		Ref. Number	
	600V		600V	
	1 Pole	3 pole	1 pole	3 pole
0-30	60306R	60308R	H212389	K214438
31-60	60606R	60608R	K212391	M214440
61-100	61036R	61038R	W204788	Z211875
101-200	62001R	62003R	V212906	B213924
201-400	64001R	64003R	D219055	M222030
401-600	6631R	6633R	J216990	E218021

A variety of pole configurations and termination provisions is available.



General Purpose US Fuses

American Power Fuses
TRI-ONIC®
TR and TRS (Class RK5 TD)

TR 15 to 600

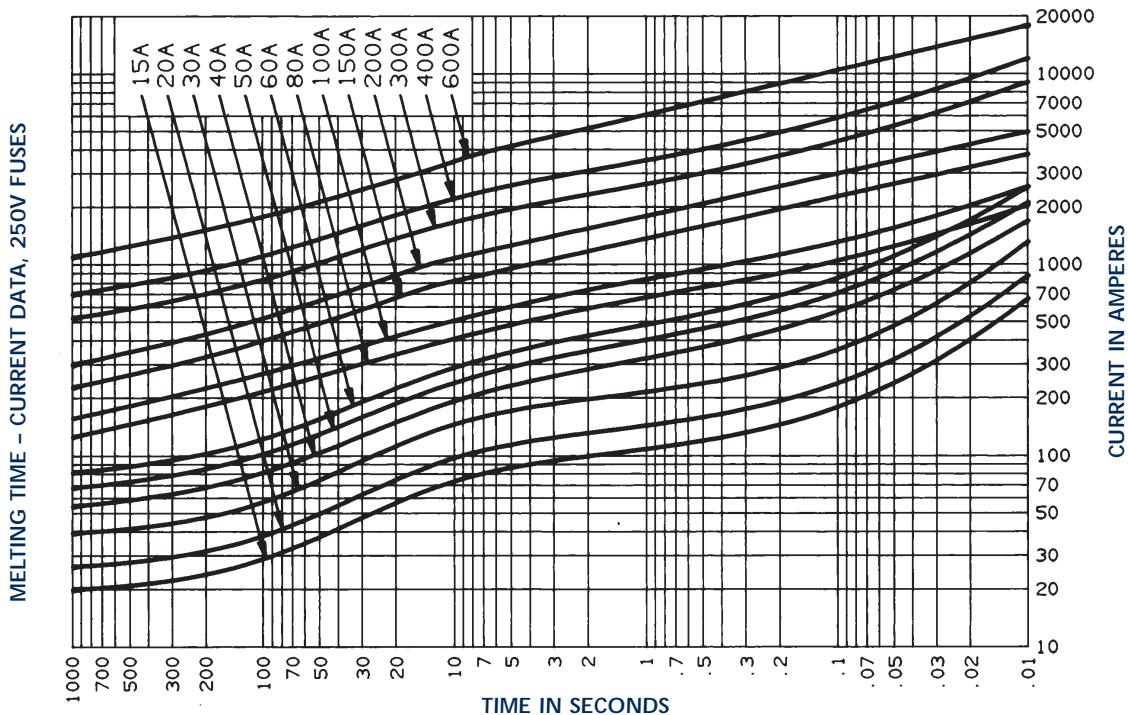

TR 1/10 to 12

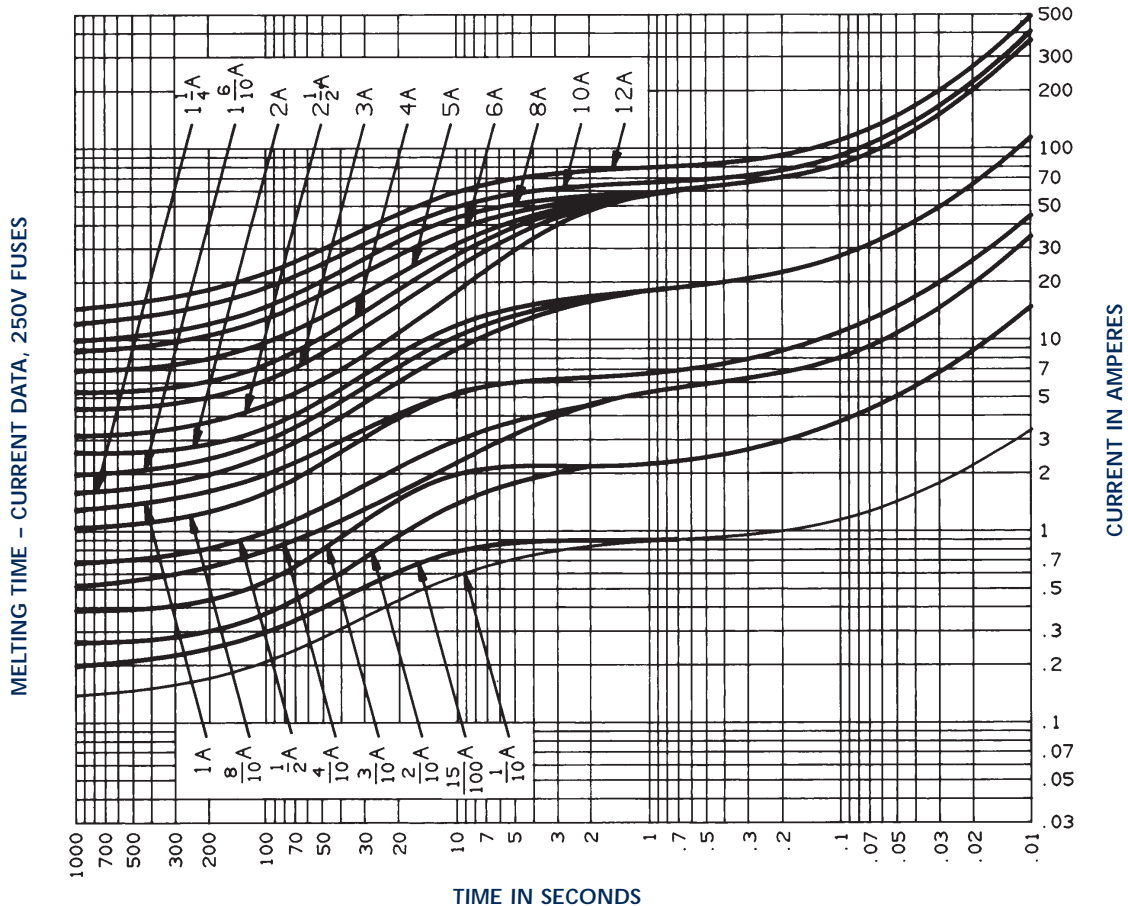

General Purpose US Fuses



American Power Fuses

TRI-ONIC®

TR and TRS (Class RK5 TD)

TRS 15 to 600

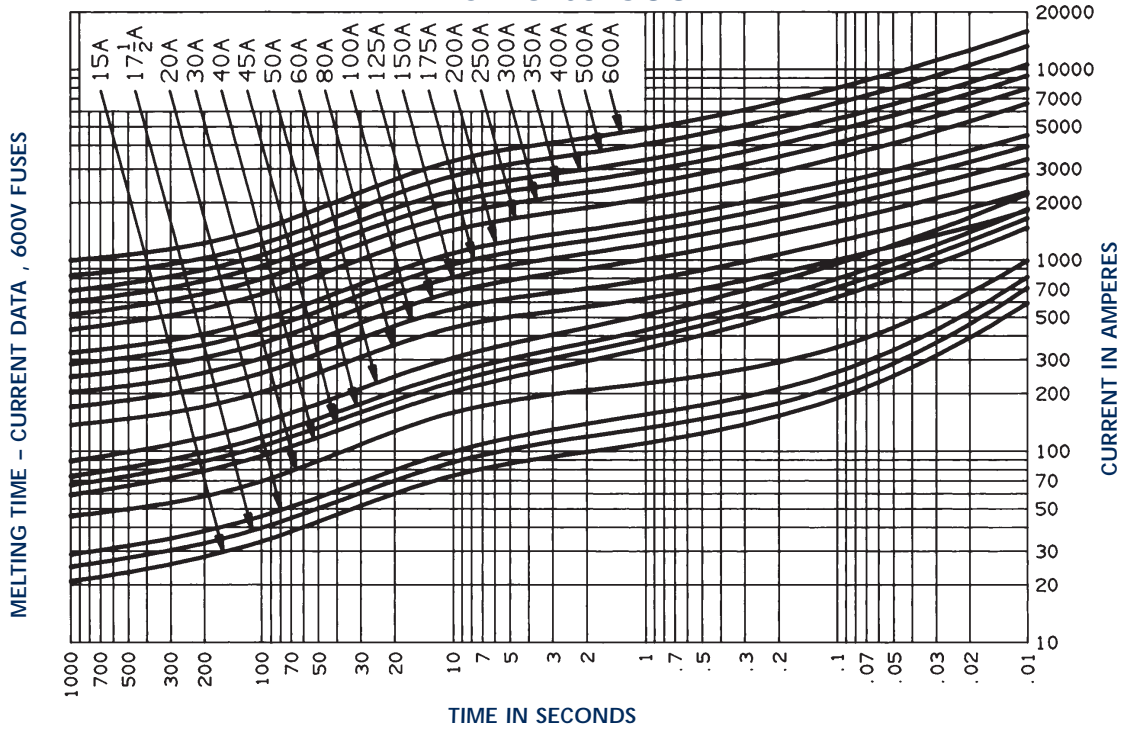

TRS 1/10 to 12

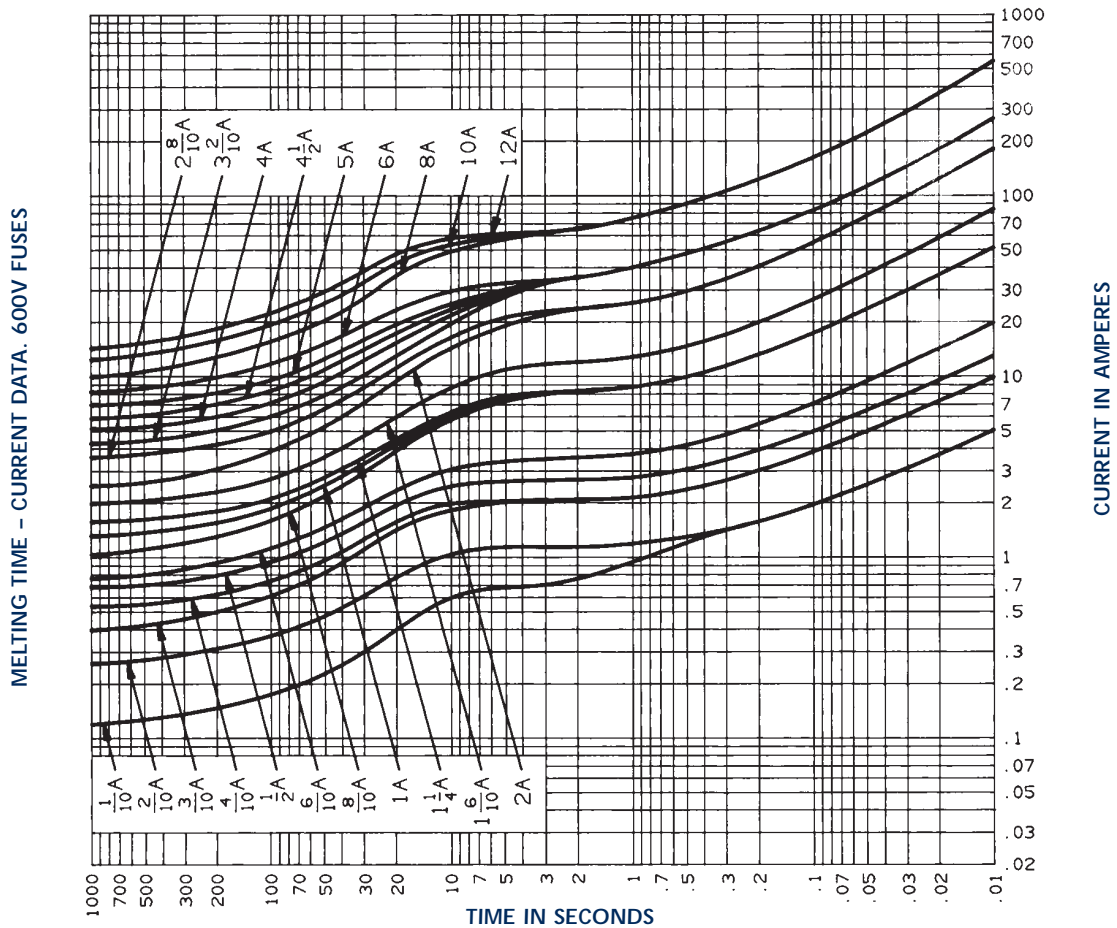



General Purpose US Fuses

American Power Fuses TRI-ONIC® TR and TRS (Class RK5 TD)

Peak Let-Thru Current Data - TR 30 to 600, 250 Volts AC

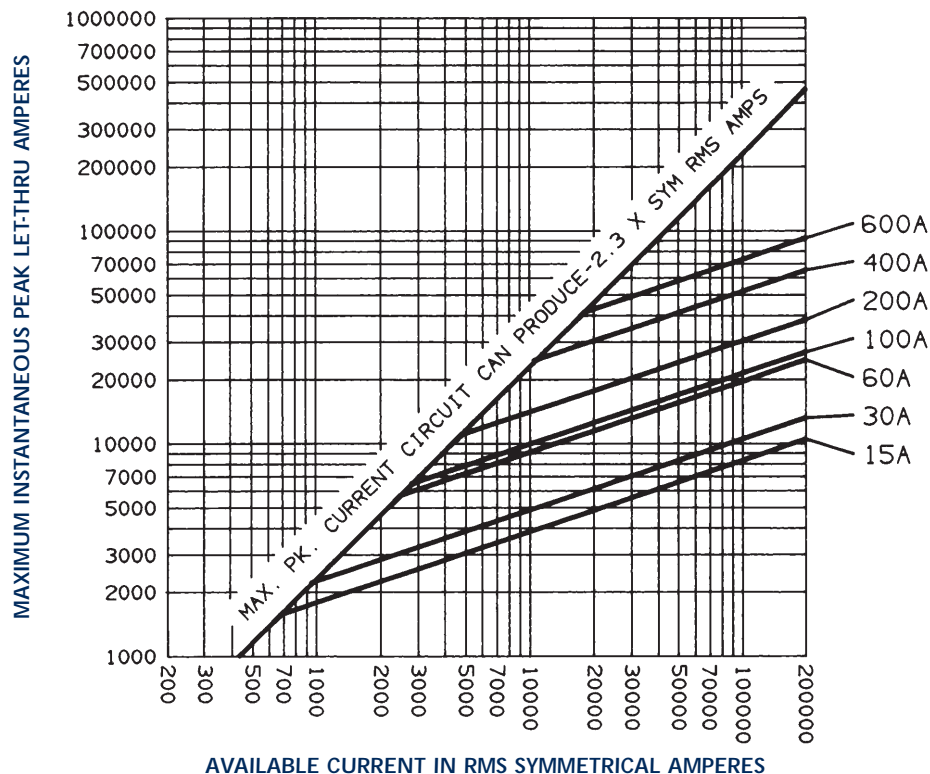

Peak Let-Thru Current Data - TRS 15 to 600, 600 Volts AC

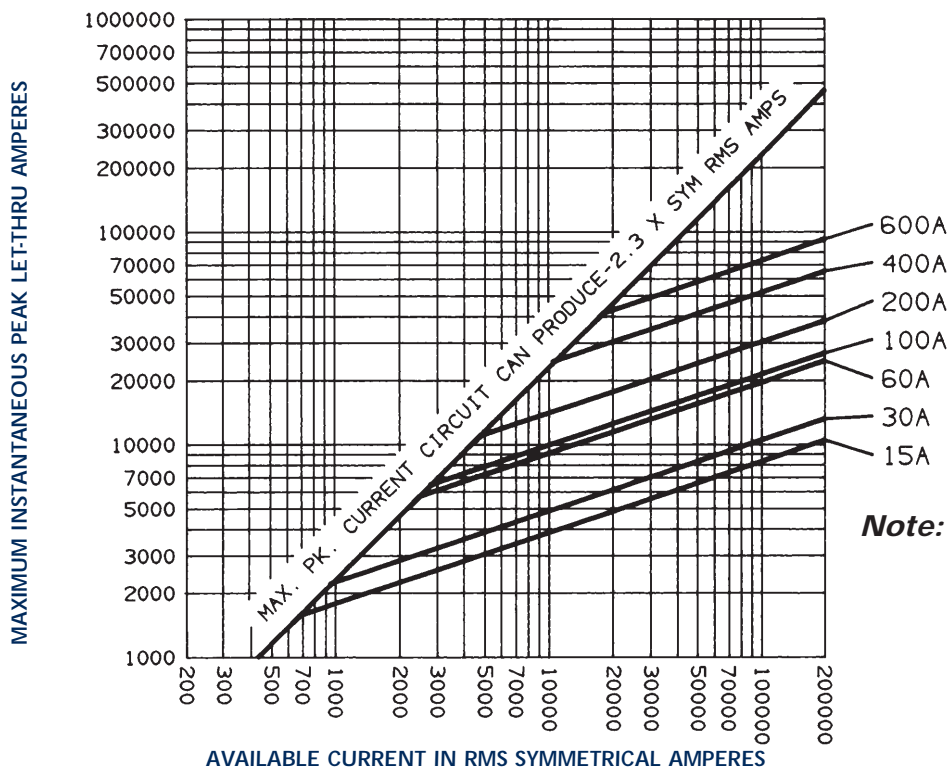

Note: See Application Information page L9 for All Motor and Transformer Tables.