



PNOZ X safety relays

Application examples for project configuration –
PNOZ X safety relays with plug-in connection terminals

pilz

Why does Pilz offer more?



Because the integrality of our business activities is what sets us apart.

Pilz is a solution supplier for all automation functions. Including standard control functions. Developments from Pilz protect man, machine and the environment. That's why all our experience and knowledge goes into individual products as well as consistently sophisticated system solutions.

- ▶ Sensor technology
- ▶ Control technology
- ▶ Networks
- ▶ Drive technology
- ▶ Operator and visualisation systems
- ▶ Software
- ▶ Consulting and engineering
- ▶ Training

Appropriate services relating to individual components and independent generic services guarantee that our customers obtain customised automation solutions, all from one source.

You can find more details about Pilz and your products and services on the Internet:

- ▶ www.pilz.com



Pilz is a family business that's closer to its customers

Pilz has a tradition as a family-run company stretching back 60 years. Real proximity to customers is visible in all areas, instilling confidence through individual consultation, flexibility and reliable service.

We are your contact, guide and competency leader en route to an optimum automation solution.

Support – Technical help round the clock!

Technical support is available from Pilz round the clock. This service is provided free of charge beyond standard business hours.

You can reach our international hotline on:

- ▶ +49 711 3409-444
- ▶ support@pilz.com

Exclusion of liability

We have taken great care in compiling our application manual. It contains information about our company and our products. All statements are made in accordance with the current status of technology and to the best of our knowledge and belief. However, we cannot except liability for the accuracy and entirety of the information provided, except in the case of gross negligence. In particular it should be noted that statements do not have the legal quality of assurances or assured properties. We are grateful for any feedback on the contents.

June 2009

All rights to this publication are reserved by Pilz GmbH & Co. KG. We reserve the right to amend specifications without prior notice. Copies may be made for the user's internal purposes. The names of products, goods and technologies used in this manual are trademarks of the respective companies.

Solution supplier for safety and standard

Pilz offers a universal concept for solutions that can be applied right across industry. Whether you need safety or standard control functions, machine or plant, centralised or decentralised, a single product or a total solution: With Pilz you will definitely find a solution for your automation function.

Are you looking for a flexible solution for your automation functions?

- ▶ **PMD:** Electronic monitoring relays such as voltage or true power monitors, for example.
- ▶ **PNOZ:** Safety relays for simple plant and machinery with up to 4 safety functions. Safe monitoring of e-stops, safety gates and light curtains/light grids, for example.
- ▶ **PNOZmulti:** The safety circuit is created using a simple configuration tool. Applicable from 4 safety functions.
- ▶ **PSS:** Programmable control systems for use on complex machinery or distributed plants, to monitor safety-related functions and/or for complete machine control.
- ▶ **Industrial communication:** Transfer input/output signals and control data reliably and safely.

Your requirements:	Our solution:	Supplementary product ranges:
	 PMD relays for electrical safety	 Sensor technology
	 PNOZ relays for functional safety	 Drive technology
	 PNOZmulti configurable control system	 Operator and visualisation systems
	 PSS programmable control systems	 Software
	 Industrial communication networks	 Services

Sensor technology, used in conjunction with Pilz safe control technology, offers a coordinated, complete solution that's economical, approved and safe. The focus is always on the protection of man and machine, in compliance with the standards and regulations.

Drive technology provides overall solutions for automating your machinery. From controller operation through to movement of highly dynamic drives, including all safety aspects.

Operator and visualisation systems provide diagnostic and visualisation devices, plus control and signal devices as part of the Pilz solution. The focus is always on fast, simple configuration. Machine downtimes are clearly reduced thanks to the overall diagnostic concept PVIS.

Software includes system software, user software and software tools. Here you'll find the right tool for every task. From product-related software to diagnostic software, through to the PAScal Safety Calculator.

Services in the field of machinery safety are covered holistically by Pilz. From risk assessment through to ESPE inspection. Pilz also offers a comprehensive range of training courses and seminars, covering generic issues relating to machinery safety as well as Pilz products.

Standards and Directives	1.0
Standards and directives	1.1
Application Examples	2.0
Emergency stop applications	2.1
Safety gate applications	2.2
ESPE applications	2.3
Muting applications	2.4
Service	3.0
Pre-sales/after sales, Your partner for practical training, Business terms and conditions	3.1

Contents	Page
Standards and Directives	
European directives and position of the standards in Europe	1.1-2
Risk assessment	1.1-4
Legal regulations outside Europe and standards for functional safety	1.1-5
Safety-related parts of control systems – General principles for design in accordance with EN ISO 13849-1	1.1-6
Functional safety and legal position of EN/IEC 61508	1.1-8
Functional safety in accordance with EN/IEC 62061	1.1-9
Risk parameters and categories in accordance with EN 954-1/EN ISO 13849-1	1.1-11

European directives and position of the standards in Europe

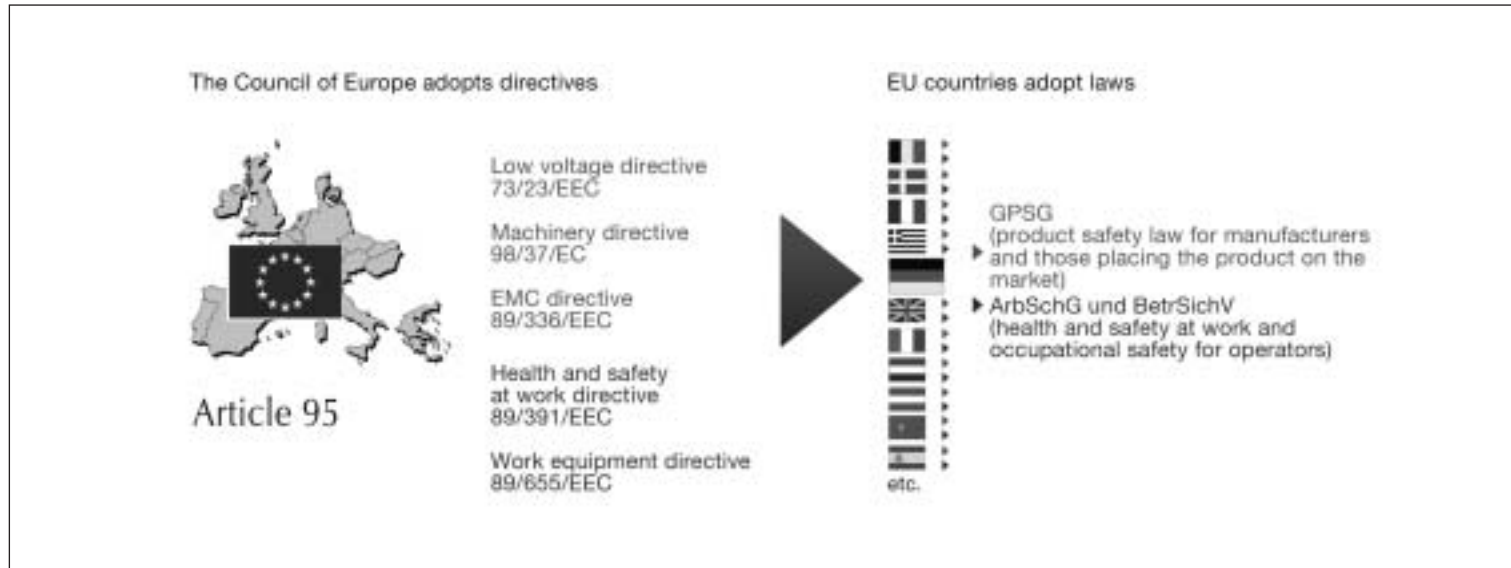

Incorporation of the directives into domestic law (using Germany as an example)

European directives

The concept of a single European internal market in terms of the “New Approach” can be traced right back to the start of the 70s: The low voltage directive is the first piece of European legislation to take into account the approach towards harmonisation of a common single market.

Products that are covered by one or more of the following directives have to apply a CE-mark, i.e. the product must be accompa-

nied by a declaration of conformity. With a declaration of conformity the manufacturer confirms that his product meets all the requirements of the European directives that relate to his product. This means he can launch and sell his product within the scope of the EU without consideration of any national regulations.

Key engineering directives:

- ▶ General product safety (2001/95/EC)
- ▶ Health and safety (89/391/EEC)
- ▶ Use of work equipment (89/655/EEC)
- ▶ Lifts (95/16/EC)
- ▶ Waste electrical and electronic equipment (2002/96/EC)
- ▶ Electromagnetic compatibility (EMC) (2004/108/EC)
- ▶ Devices for use in potentially explosive areas (ATEX) (94/9/EC)
- ▶ Machinery (98/37/EC) / (2006/42/EC)

- ▶ Low voltage equipment (2006/95/EC)
- ▶ Personal protective equipment (89/686/EEC)
- ▶ Cable cars (2000/9/EC)

The directives are addressed to member states, who are obliged to incorporate the European directives into domestic law. In Germany this is normally achieved through the device safety law.

European directives and position of the standards in Europe

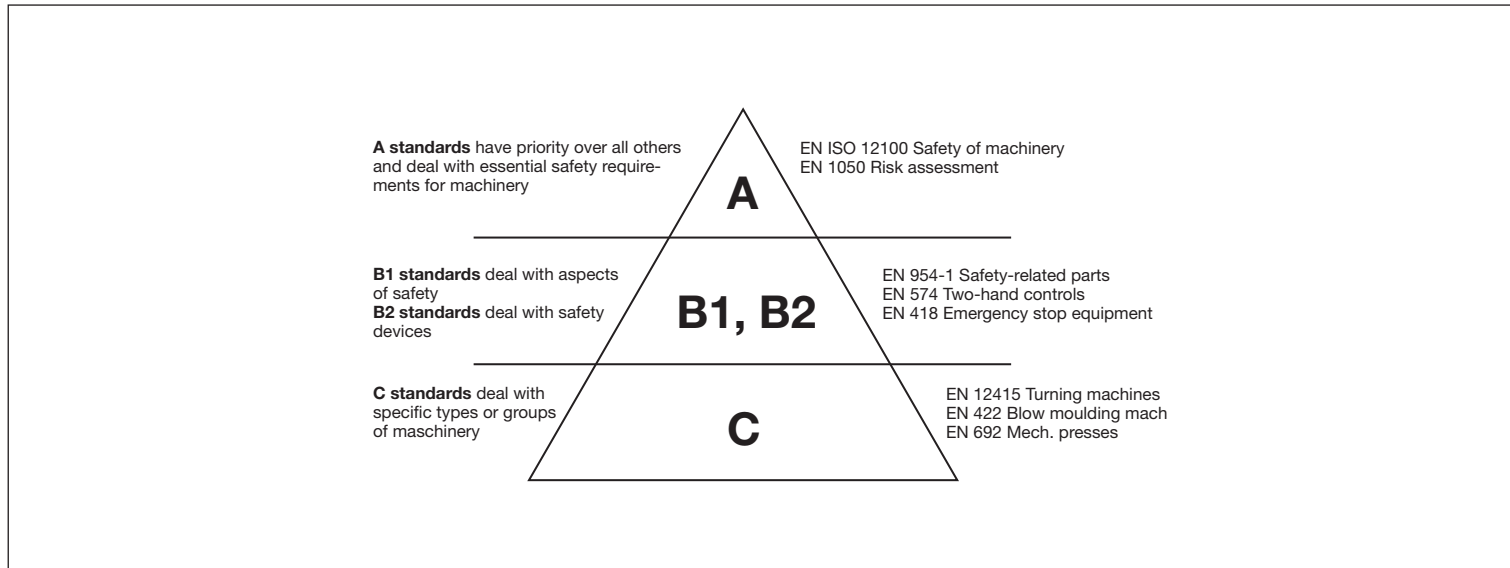

Standards pyramid

Position of the standards in Europe

The legal position of standards is discussed again and again. Inside Europe, i.e. within the scope of the European directives that are subject to the CE-marking obligation, a manufacturer is not bound by standards or other specifications. He simply needs to comply with the health and safety requirements of the directive(s). The associated benefits of a division between standards and legislation are obvious: It is easier for legislators to agree on the essential requirements than on technical details. Also, the directives

do not regularly have to be adapted to the state of technology; member states can use their own legal system for incorporation and manufacturers are free to select the ways in which they implement the requirements of the directive.

So what are the benefits of applying the standards? With so-called harmonised standards with presumption of conformity, there is a shifting of the burden of proof, i.e. if manufacturers apply these standards, it is presumed that they will also comply with the specific requirements of the European

directives. The regulatory authorities would therefore need to prove that a manufacturer did not meet the legal requirements.

However, should a manufacturer deviate from the harmonised standards, he himself must prove how he has met the essential safety requirements. This is generally done via a hazard analysis. In practice one would endeavour to apply the harmonised standards, unless the products concerned are highly innovative and no harmonised standards yet exist. The standards for which this “presumption effect” applies can be researched

in the Official Journal of the EU (e.g. on the Internet). Standards in Europe are subdivided into what are termed A, B and C standards.

Risk assessment

Risk assessment

Under the terms of the machinery directive, a machine manufacturer must assess the hazards in order to identify all the hazards that apply to his machine. He must then design and construct the machine to take account of his assessment. This requirement also applies to operators who act as manufacturers under the terms of the machinery directive. For example, this may occur with machines that are interlinked or for machinery that has been upgraded and substantially modified.

EN ISO 14121-1 contains “Principles for risk assessment” on machinery. These approaches can be called upon as part of a comprehensive analysis. EN ISO 13849-1 expands on EN ISO 14121-1 with regard to the assessment of safety-related parts of control systems.

The hazards emanating from a machine may be many and varied, so for example, it is necessary to consider not just mechanical hazards through crushing and shearing, but also thermal and electrical hazards and hazards from radiation. Risk reduction is therefore an iterative process, i.e. it is carried out before and during the planning phase and after completion of the plant or machine.

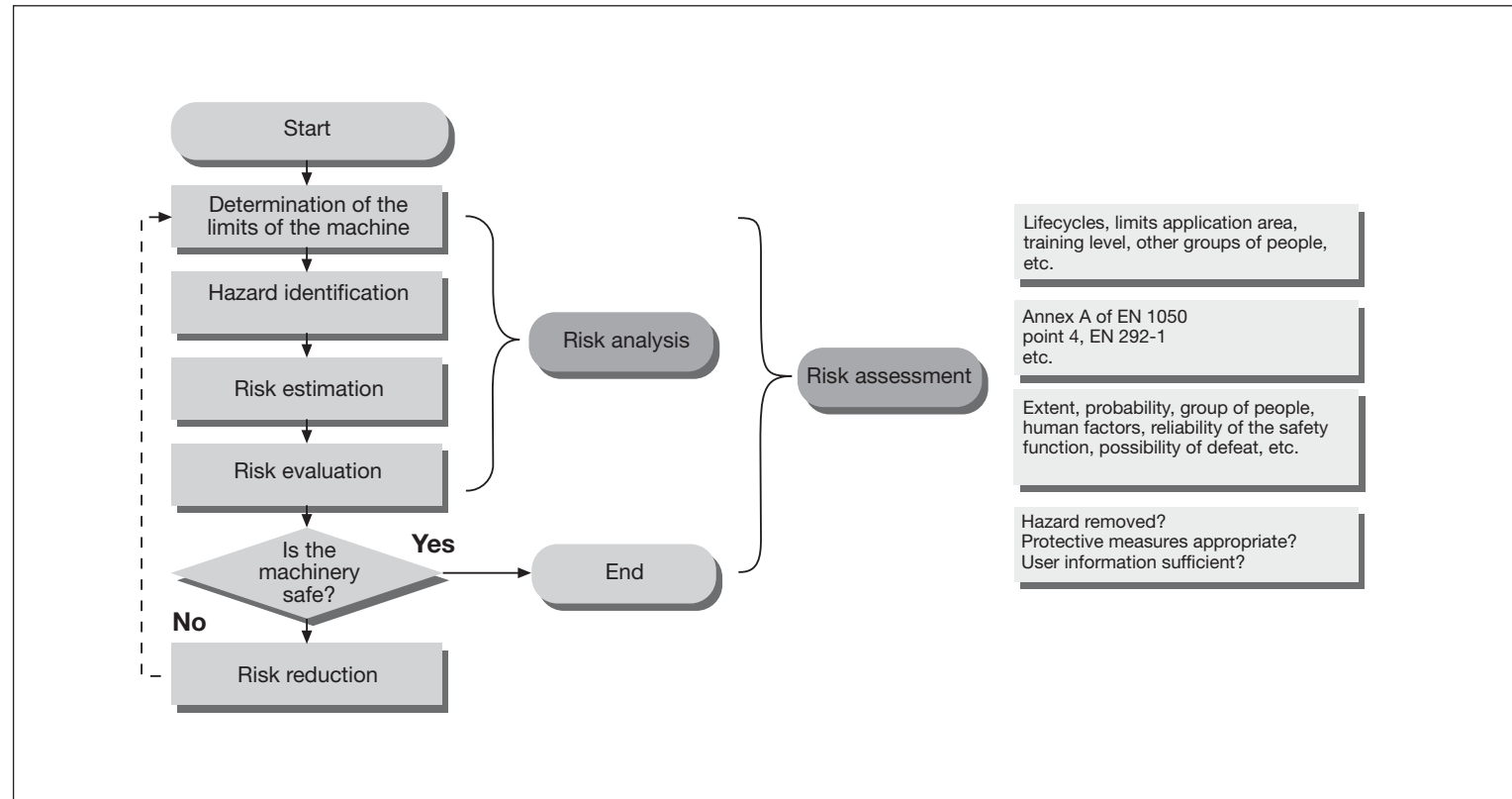

Iterative process in accordance with EN ISO 14121-1

Legal regulations outside Europe and standards for functional safety

Legal regulations outside Europe

The situation is somewhat different in the USA: people there are mainly familiar with two types of standards: ANSI (American National Standards Institute) and OSHA (Occupational Safety and Health Administration).

OSHA standards are published by the state and compliance is mandatory. ANSI standards, on the other hand, are developed by private organisations and their application is generally not absolutely essential. However, ANSI standards can still be found included as part of a contract. Beyond that ANSI standards are being taken over by OSHA. You can also still come across the NFPA (National Fire Protection Association), which developed NFPA 79 as a counterpart to EN 60204-1, for example. The OSHA standards can be compared with the European directives. Unlike the European directives, OSHA standards are more involved with formulating technical specifications than abstract requirements.

The legal basis in the USA can be seen as a mix of product standards, fire codes (NFPA), electrical codes (NEC) and national laws. Local government bodies have the authority to monitor that these codes are being enforced and implemented.

Russia and the CIS states have implemented GOST-R certification for some years now, in other words, technical devices that fall within a specific product area must undergo a cer-

tain certification process. Machinery and any corresponding technical accessories undergo a type approval test through a European notified body, for example. This test is generally recognised by a Russian-based approvals body. From the point of view of safety, the same requirements apply as in Europe.

China, on the other hand, has introduced CCC certification. Similar to the position in Russia, technical products are subject to mandatory certification through a national approvals body in China. In addition, production sites are inspected. If a technical device falls with the scope of the product list, which is subdivided into 19 categories, certification is mandatory, otherwise it will be necessary to supply a type of “declaration of no objection” from a national notified body.

Japan is currently in a transition period: The plan is for Japan to adopt the European “new approach” – in other words, to keep standards and legislation separate. At the moment the international ISO and IEC standards are being directly incorporated into national legislation, which is why people are currently confronted with frequent amendments to laws and lengthy implementation periods.

Standards for functional safety

Different standards may be called upon to observe functional safety on control systems, depending on the application. In the area of machine safety, EN ISO 13849-1 is the main standard named for safety-related

control systems. Irrespective of the technology, this applies for the whole chain from the sensor to the actuator. The risk graphs and corresponding risk parameters can be used to estimate the potential risk for danger zones on machinery. The category is then established without the use of risk-reducing measures.

Safety-related parts of control systems – General principles for design in accordance with EN ISO 13849-1

Determination of the required Performance Level (PL_r)

▶ **S – Severity of injury**

- S₁ = Slight (normally reversible injury)
- S₂ = Serious (normally irreversible injury, including death)

▶ **F – Frequency and/or exposure to a hazard**

- F₁ = Seldom to less often and/or the exposure time is short
- F₂ = Frequent to continuous and/or the exposure time is long

▶ **P – Possibility of avoiding the hazard or limiting the harm**

- P₁ = Possible under specific conditions
- P₂ = Scarcely possible

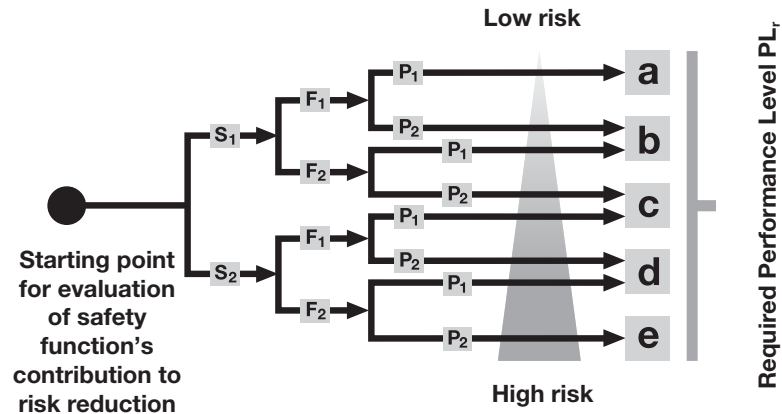

Safety-related parts of control systems – General principles for design in accordance with EN ISO 13849-1

As the successor standard to EN 954-1, EN ISO 13849-1 is based on the familiar categories. Equally, it examines complete safety functions, including all the components involved in their design. EN ISO 13849-1 goes beyond the qualitative approach of EN 954-1 to include a quantitative assessment of the safety functions. A performance level (PL) is used for this, building upon the categories.

Components/devices require the following safety parameters:

- ▶ Category (structural requirement)
- ▶ PL: Performance level
- ▶ MTTF_d: Mean time to dangerous failure
- ▶ DC: Diagnostic coverage
- ▶ CCF: Common cause failure

The standard describes how to calculate the performance level (PL) for safety-related parts of control systems, based on designated architectures. EN ISO 13849-1 refers any deviations to IEC 61508.

Risk assessment in accordance with EN ISO 13849-1

Risk assessment is an iterative process, i.e. it will need to be carried out more than once. The risk must be estimated and the performance level defined for each hazard on which the risk is to be reduced through control measures. The risk is estimated through consideration of the severity of injury (S), the frequency and duration of exposure to the hazard (F) and the possibility of avoiding or limiting the harm (P).

Parameters S, F and P are used on the risk graph to determine the required performance level (PL_r) for a safety function. The selection of parameters is no different to the procedure used in EN 954-1 (1996). However, the result is no longer a category but a PL.

Safety-related parts of control systems – General principles for design in accordance with EN ISO 13849-1

Performance Levels (PL) in accordance with EN ISO 13849-1	Probability of a dangerous failure per hour [1/h]
a	$10^{-5} < PFH < 10^{-4}$
b	$3 \times 10^{-6} < PFH < 10^{-5}$
c	$10^{-6} < PFH < 3 \times 10^{-6}$
d	$10^{-7} < PFH < 10^{-6}$
e	$10^{-8} < PFH < 10^{-7}$

Performance level

The performance level (PL) classifies 5 levels of probability of failure. The table shows the relationship between PL and the probability of dangerous failure per hour PFH_D .

Once the required PL has been established, the PL achieved by the safety function (SRP/CL) is calculated. To do this the SRP/CL can be divided into logical blocks, such as input, logic solving and output for example.

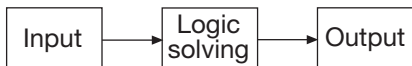

When using a designated architecture or an architecture of similar structure, the achieved PL can be calculated graphically using the bar chart. To do this the architecture of the SRP/CL is divided into categories. $MTTF_D$ and DC_{avg} are also required. From Category 2 onwards, the CCF will also need to be

examined. A component's $MTTF_D$ value is usually provided by the manufacturer. The standard provides tables and check lists for calculating the other values.

It is also possible to calculate the achieved PL of an SRP/CL. The probability of dangerous failure of all the blocks that combine to form the safety function is added up:

$$PFH_{System} = PFH_{Input} + PFH_{Logic} + PFH_{Output}$$

The PL achieved by an SRP/CL must be at least as high as the PL required by the safety function.

If this condition is not met, the safety function must be implemented differently.

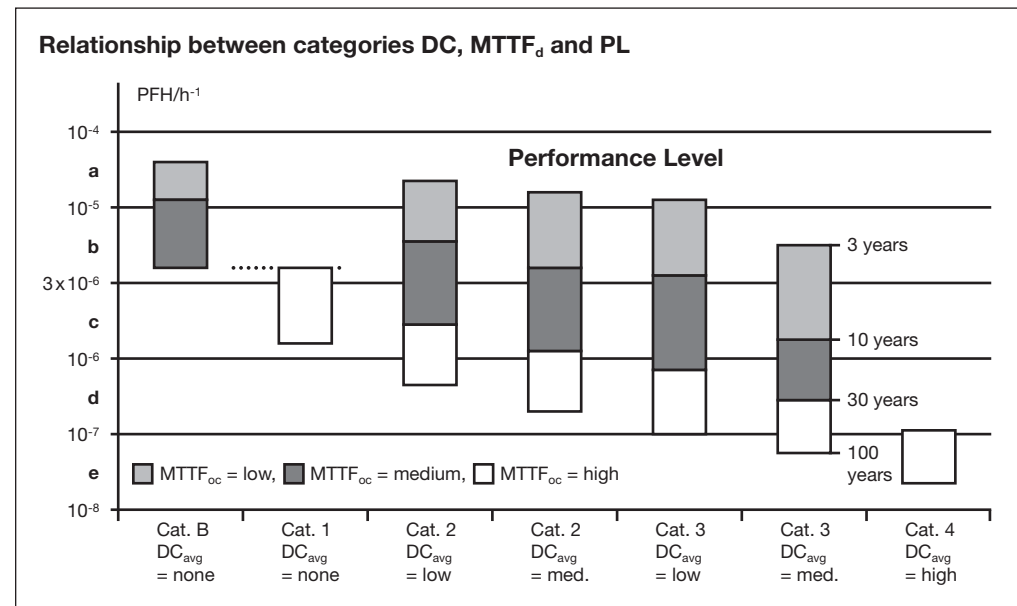

Functional safety and legal position of EN/IEC 61508

Functional safety with EN/IEC 61508?

EN/IEC 61508 is regarded as a generic safety standard, which deals with the functional safety of electrical, electronic and programmable electronic systems, irrespective of the application.

One of the main tasks of EN/IEC 61508 is to serve as a basis for the development of application-oriented standards. Standards' committees are currently busy in the areas of machine safety with EN/IEC 62061, and process safety with EN/IEC 61511.

These sector-specific standards are intended to continue the principle approaches of EN/IEC 61508 and to implement the requirements for the relevant application area in a suitably practical manner.

What is the legal status of EN/IEC 61508?

As EN/IEC 61508 is not listed in the Official Journal of the European Communities for implementation as a European directive, it lacks the so-called "effect of presumption", so if the standard is used on its own, a control system designer cannot presume that the relevant requirements of the specific European directive have been met.

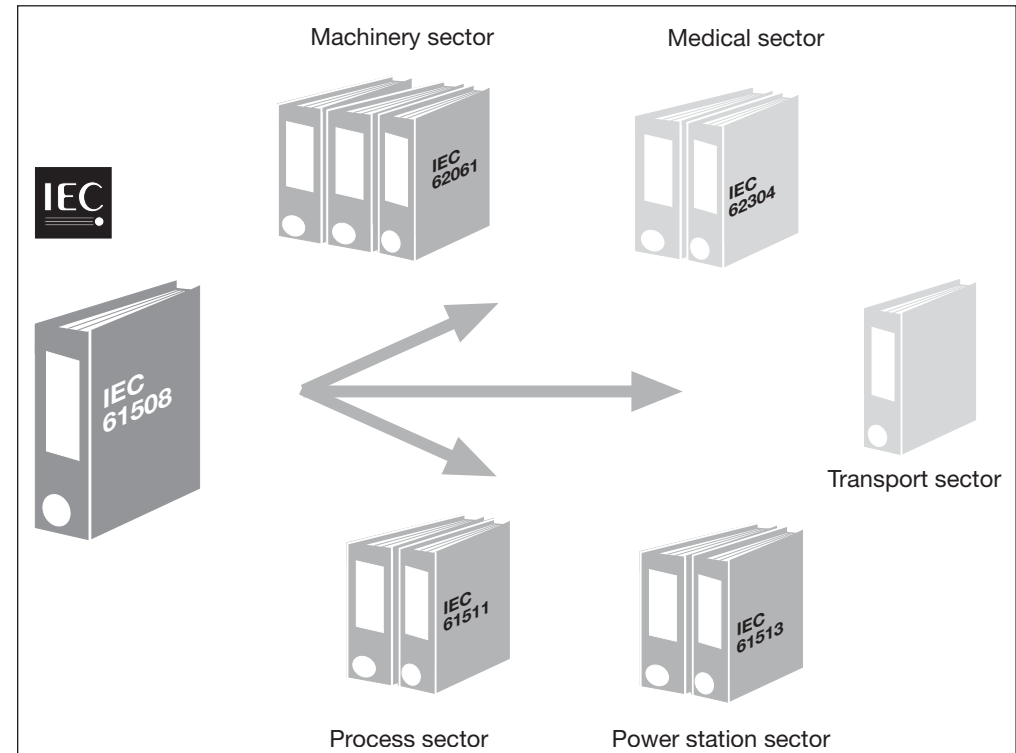

Sector standards from EN/IEC 61508

Functional safety in accordance with EN/IEC 62061

Risk assessment and determination of required Safety Integrity Level (SIL)												
Consequences	S	Class CI					Frequency and duration	Fr	Probability of hzd. event		Avoidance	
		3-4	5-7	8-10	11-13	14-15			Pr	Av	P	
Death, losing an eye or arm	4	SIL 2	SIL 2	SIL 2	SIL 3	SIL 3	≤ 1 hour	5	Very high	5		
Permanent, losing fingers	3		OM	SIL 1	SIL 2	SIL 3	> 1 h – ≤ 1 day	5	Likely	4		
Reversible, medical attention	2			OM	SIL 1	SIL 2	> 1 day – ≤ 2 wks	4	Possible	3	Impossible	5
Reversible, first aid	1				OM	SIL 1	> 2 wks – ≤ 1 year	3	Rarely	2	Possible	3
							> 1 year	2	Negligible	1	Likely	1

AM = Other measures recommended

Functional safety of safety-related electrical, electronic and programmable electronic control systems in accordance with EN/IEC 62061

EN/IEC 62061 represents a sector-specific standard under EN/IEC 61508. It describes the implementation of safety-related electrical control systems on machinery and examines the overall lifecycle from the concept phase through to decommissioning. Quantitative and qualitative examinations of the safety functions form the basis.

Risk estimation is an iterative process, i.e. it will need to be carried out more than once. The risk must be estimated and the SIL defined for each hazard on which the risk is to be reduced through control measures. The risk is estimated through consideration of the severity of injury (Se), the frequency and duration of exposure to the hazard (Fr), probability of occurrence of a hazardous event (Pr) and the possibility of avoiding or limiting the harm (Av).

The required SIL is assigned using the table above, where $CI = Fr + Pr + Av$.

Functional safety in accordance with EN/IEC 62061

Safety Integrity Level (SIL) in accordance with EN IEC 62061	Probability of a dangerous failure per hour [1/h]
No special safety requirement	$10^{-5} < PFH < 10^{-4}$
1 (1 failure in 100 000 h)	$3 \times 10^{-6} < PFH < 10^{-5}$
1 (1 failure in 100 000 h)	$10^{-6} < PFH < 3 \times 10^{-6}$
2 (1 failure in 1 000 000 h)	$10^{-7} < PFH < 10^{-6}$
3 (1 failure in 10 000 000 h)	$10^{-8} < PFH < 10^{-7}$

SIL assignment

The safety integrity level (SIL) classifies three levels of probability of failure. The table shows the relationship between SIL and the probability of dangerous failure per hour (PFH_D).

The SRECS (safety-related electrical control system) is divided into subsystems. The subsystems are assigned to actual devices. The SIL must be defined for each subsystem.

The probability of a dangerous failure is calculated by adding the probabilities of failure of all the subsystems of the SRECS:

$$PFH_D = PFH_{D1} + \dots + PFH_{Dn}$$

The selection or design of the SRECS must always meet the following minimum requirements:

Requirements for hardware safety integrity, comprising

- ▶ Architectural constraints for hardware safety integrity
- ▶ Requirements for the probability of dangerous random hardware failures

plus requirements for systematic safety integrity, comprising

- ▶ Requirements for avoidance of failures and
- ▶ Requirements for the control of systematic failures.

The following parameters are required in assessing hardware safety integrity:

- λD: Dangerous failure rate
- T1: Proof test
- T2: Diagnostic test interval
- DC: Diagnostic coverage
- β: Common cause failure

The calculated probability of failure (PFHD) of each SRECS must be less than the probability of failure required by the safety function. The required probability of failure, depending on the SIL, can be taken from the table. If this condition is not met, the safety function must be implemented differently.

The achieved SIL can only be as high as the lowest SILCL (SIL Claim Limit) of a subsystem involved in performing the safety function.

Safe failure fraction (SFF)	Hardware fault tolerance 0	Hardware fault tolerance 1	Hardware fault tolerance 2
< 60 %	Not allowed	SIL 1	SIL 2
60 % – < 90 %	SIL 1	SIL 2	SIL 3
90 % – < 99 %	SIL 2	SIL 3	SIL 3
99 %	SIL 3	SIL 3	SIL 3

Risk parameters and categories in accordance with EN 954-1/EN ISO 13849-1¹⁾

Risk parameters

S = Severity of injury:

- 1 = Slight (normally reversible) injury
- 2 = Serious (normally irreversible) injury, including death

F = Frequency and/or exposure to the hazard:

- 1 = Seldom to quite often and/or exposure time is short
- 2 = Frequent to continuous and/or exposure time is long

P = Possibility of avoiding the hazard:

- 1 = Possible under specific conditions
- 2 = Scarcely possible

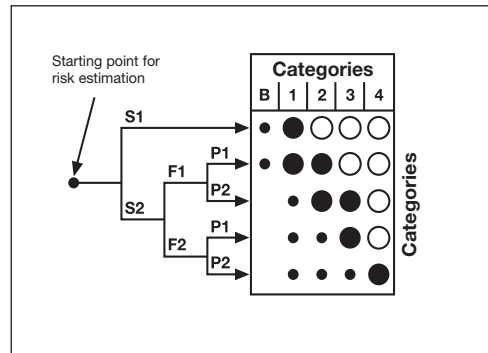

Risk graph from EN 954

Categories in accordance with EN 954-1

The control system requirements derived from the risk graph are specified as follows:

Category B

Basic category with no special requirements = "good industrial standard"

Category 1

Safety-related parts must be designed and constructed using well-tried components and well-tried safety principles.

Well-tried means: the components have been widely used in the past with successful results in similar applications, or they have been manufactured using principles that demonstrate its suitability and reliability for safety-related applications.

Example: safety switch with forced-opening contacts.

Well-tried safety principles are circuits that are constructed in such a way that certain faults can be avoided by the appropriate arrangement or layout of components.

Example: avoiding a short circuit through appropriate separation, avoiding component failures that result from overdimensioning, using the failsafe principle (on switching off).

Note: The occurrence of a fault can lead to the loss of the safety function.

Category 2

Safety-related parts of control systems must

be designed so that their safety function(s) are checked at suitable intervals by the machine control system. The safety function(s) must be checked: at the machine start-up and prior to the initiation of any hazardous situation; periodically during operation, if the risk assessment and the kind of operation show that it is necessary.

This check may be initiated automatically or manually. Automatically, for example, the check may be initiated by a signal generated from a control system at suitable intervals. The automatic test should be provided by preference. The decision about the type of test depends on the risk assessment and the judgement of the end user or machine builder. If no fault is detected, operation may be approved as a result of the test. If a fault is detected, an output must be generated to initiate appropriate control action. A second, independent shutdown route is required for this.

Notes: In some cases Category 2 is not applicable because the checking of the safety function cannot be applied to all components and devices. Moreover, the cost involved in implementing Category 2 correctly may be considerable, so that it may make better economic sense to implement a different category.

In general Category 2 can be realised with electronic techniques. The system behaviour allows the occurrence of a fault to lead to the loss of the safety function between checks; the loss of the safety function is detected by the check.

Category 3

Safety-related parts of control systems must be designed so that a single fault in any of these parts does not lead to the loss of the safety function.

Whenever reasonably practicable, the single fault shall be detected at or before the next demand upon the safety function.

This does not mean that all faults will be detected. The accumulation of undetected faults can lead to an unintended output signal and a hazardous situation at the machine.

Category 4

Safety-related parts of control systems must be designed so that a single fault in any of these parts does not lead to a loss of the safety function; the single fault must be detected at or before the next demand upon the safety functions (e.g. immediately at switch on, at the end of a machine operating cycle). If this detection is not possible, then an accumulation of faults shall not lead to a loss of the safety function.

¹⁾ Only applicable until November 2009. Replaced by EN ISO 13849-1

Contents	Page
Emergency stop applications	
PNOZ X3P – Interlinked machines, galvanically isolated	PL e of EN ISO 13849-1, SIL 3 of EN 62061 2.1-2
PNOZ X3.10P – Automatic reset after power supply failure	PL d of EN ISO 13849-1, SIL 2 of EN 62061 2.1-8
PNOZ X9P – Interlinked machines, galvanically isolated	PL e of EN ISO 13849-1, SIL 3 of EN 62061 2.1-11
PNOZ X10.11P – Interlinked machines, galvanically isolated	PL e of EN ISO 13849-1, SIL 3 of EN 62061 2.1-17
PNOZ X10.11P – Interlinked machines, galvanically isolated	PL e of EN ISO 13849-1, SIL 3 of EN 62061 2.1-23
PNOZ XV1P – Safe standstill of a drive	PL d of EN ISO 13849-1, SIL 2 of EN 62061 2.1-29

PL e of EN ISO 13849-1, SIL 3 of EN 62061

PNOZ X3P – Interlinked machines, galvanically isolated

Features

- ▶ Dual-channel operation with detection of shorts across contacts
- ▶ Series connection of two E-STOP pushbuttons
- ▶ Interlinked machines (Master-Slave), galvanically isolated
- ▶ Monitored reset
- ▶ Contact expansion through PZE X5P and positive-guided contactors
- ▶ Feedback circuit to monitor contact expansion

Description

E-STOP function

When one of the E-STOP pushbuttons S12, S13 is operated, machine 1 (Master) plus machines 2 and 3 (Slaves) are stopped.

When one of the E-STOP pushbuttons is operated, the input circuit on the safety relay PNOZ X3P (K14) is opened and the safety contacts on K14 open. This interrupts the input circuit on the contact expander module PZE X5P (K15) and contactors K16 and K17 de-energise. The safety contacts on the PZE X5P open. This also interrupts the input circuits on the safety relays PNOZ X3P (K18 and K21). Their safety contacts open and contactors K19, K20, K22 and K23 de-energise.

The safety relays PNOZ X3P (K14, K18, K21) and contact expander module PZE X5P (K15) have diagnostic outputs for display or

for evaluation by a PLC.

Start/reset

The safety relay PNOZ X3P (K14, machine 1) can be started by pressing reset button S14 if:

- ▶ E-STOP pushbuttons (S12, S13) have not been operated and
- ▶ The relays on the contact expander module PZE X5P (K15) have de-energised and
- ▶ Contactors K16 and K17 have de-energised.

The safety relay PNOZ X3P (K18, machine 2) is started automatically if:

- ▶ The safety contacts on K15 are closed and
- ▶ Contactors K19 and K20 have de-energised.

The safety relay PNOZ X3P (K21, machine 3) is started automatically if:

- ▶ The safety contacts on K15 are closed and
- ▶ Contactors K22 and K23 have de-energised.

Feedback circuit

The positive-guided N/C contacts on contactors K16 and K17, the feedback loop from contact expander module PZE X5P (K15) and the reset button S14 are connected to the reset/feedback circuit S33/S34 on the safety relay PNOZ X3P (K14) (machine 1, Master).

The positive-guided N/C contacts on contactors K19 and K20 are connected to the feedback circuit S13/S14 on the safety

relay PNOZ X3P (K18) (machine 2, Slave). The positive-guided N/C contacts on contactors K22 and K23 are connected to the feedback circuit S13/S14 on the safety relay PNOZ X3P (K21) (machine 3, Slave).



CAUTION!

The FL monitoring from machine 2 and 3 (Slave) is not passed to machine 1 (Master). It is detected by the operator on start-up.

Safety assessment

- ▶ The safety relay PNOZ X3P (K14), the contact expander module PZE X5P (K15) and contactors K16 and K17 must be installed in a single mounting area (control cabinet) in order to exclude a short across the output (machine 1).
- ▶ The safety relay PNOZ X3P (K18) and contactors K19 and K20 must be installed in a single mounting area (control cabinet) in order to exclude a short across the output (machine 2).
- ▶ The safety relay PNOZ X3P (K21) and contactors K22 and K23 must be installed in a single mounting area (control cabinet) in order to exclude a short across the output (machine 3).

- ▶ Earth faults and shorts between contacts in the input circuit are detected.
- ▶ An fault on the device does not lead to the loss of the safety function.
- ▶ The safety relay PNOZ X3P (K14) can be started when the input circuit at K14 is closed first, followed by the reset button S14. This avoids an unwanted reset before the input circuit is closed or as a result of the reset button being overridden.
- ▶ E-STOP pushbuttons may be connected in series if it's possible to predict that only one E-STOP pushbutton will be operated at a time. The category is restricted to 3 with series connection.

Pilz products

Number	Description	Order number
3	PNOZ X3P	777 313
1	PZE X5P	777 150
2	PITestop Set1.1	400 410

Emergency stop applications

PL e of EN ISO 13849-1, SIL 3 of EN 62061

PNOZ X3P – Interlinked machines, galvanically isolated

Safety-related characteristics in accordance with EN ISO 13849-1

Prerequisites:

- ▶ Common cause failure (CCF): Requirements are considered to be met (must be tested on implementation)
- ▶ Mission time: 20 years
- ▶ Operating interval (electromechanical components):
 - Sensor: One operation per week
 - Actuator: Two operations per week
- ▶ Characteristic data of contactors K16, K17, K19, K20, K22, K23: B10d: 2,000,000

EN ISO 13849-1		Performance Level	Safety-related parts of the control system
Safety function 1-2:	Machine shut down via E-STOP	PL e	Sensor (PITestop) Logic (PNOZ X3P K14) Actuator (contactors K16, K17)
Safety function 3-4:	Machine shut down via E-STOP	PL e	Sensor (PITestop) Logic (PNOZ X3P K14) Logic (PZE X5P K15) Logic (PNOZ X3P K18) Actuator (contactors K19, K20)
Safety function 5-6:	Machine shut down via E-STOP	PL e	Sensor (PITestop) Logic (PNOZ X3P K14) Logic (PZE X5P K15) Logic (PNOZ X3P K21) Actuator (contactors K22, K23)

Please note the further requirements of EN ISO 13849-1, e.g. requirements for avoiding systematic faults.

Emergency stop applications

PL e of EN ISO 13849-1, SIL 3 of EN 62061

PNOZ X3P – Interlinked machines, galvanically isolated

Safety-related characteristics in accordance with EN 62061

Prerequisites:

- ▶ Common cause failure (CCF): $\beta = 2 \%$ (must be tested on implementation)
- ▶ Proof test interval: 20 years
- ▶ Operating interval (electromechanical components):
 - Sensor: One operation per week
 - Actuator: Two operations per week
- ▶ Characteristic data of contactors K16, K17, K19, K20, K22, K23:
 - B10d: 2,000,000
 - Dangerous failure rate: 65%

EN 62061		Safety Integrity Level	Subsystems
Safety-related control function (SRCF 1-2):	Machine shut down via E-STOP	SIL 3	Sensor (PITestop) Logic (PNOZ X3P K14) Actuator (contactors K16, K17)
Safety-related control function (SRCF 3-4):	Machine shut down via E-STOP	SIL 3	Sensor (PITestop) Logic (PNOZ X3P K14) Logic (PZE X5P K15) Logic (PNOZ X3P K18) Actuator (contactors K19, K20)
Safety-related control function (SRCF 5-6):	Machine shut down via E-STOP	SIL 3	Sensor (PITestop) Logic (PNOZ X3P K14) Logic (PZE X5P K15) Logic (PNOZ X3P K21) Actuator (contactors K22, K23)

Please note the further requirements of EN 62061, e.g. requirements for systematic safety integrity.

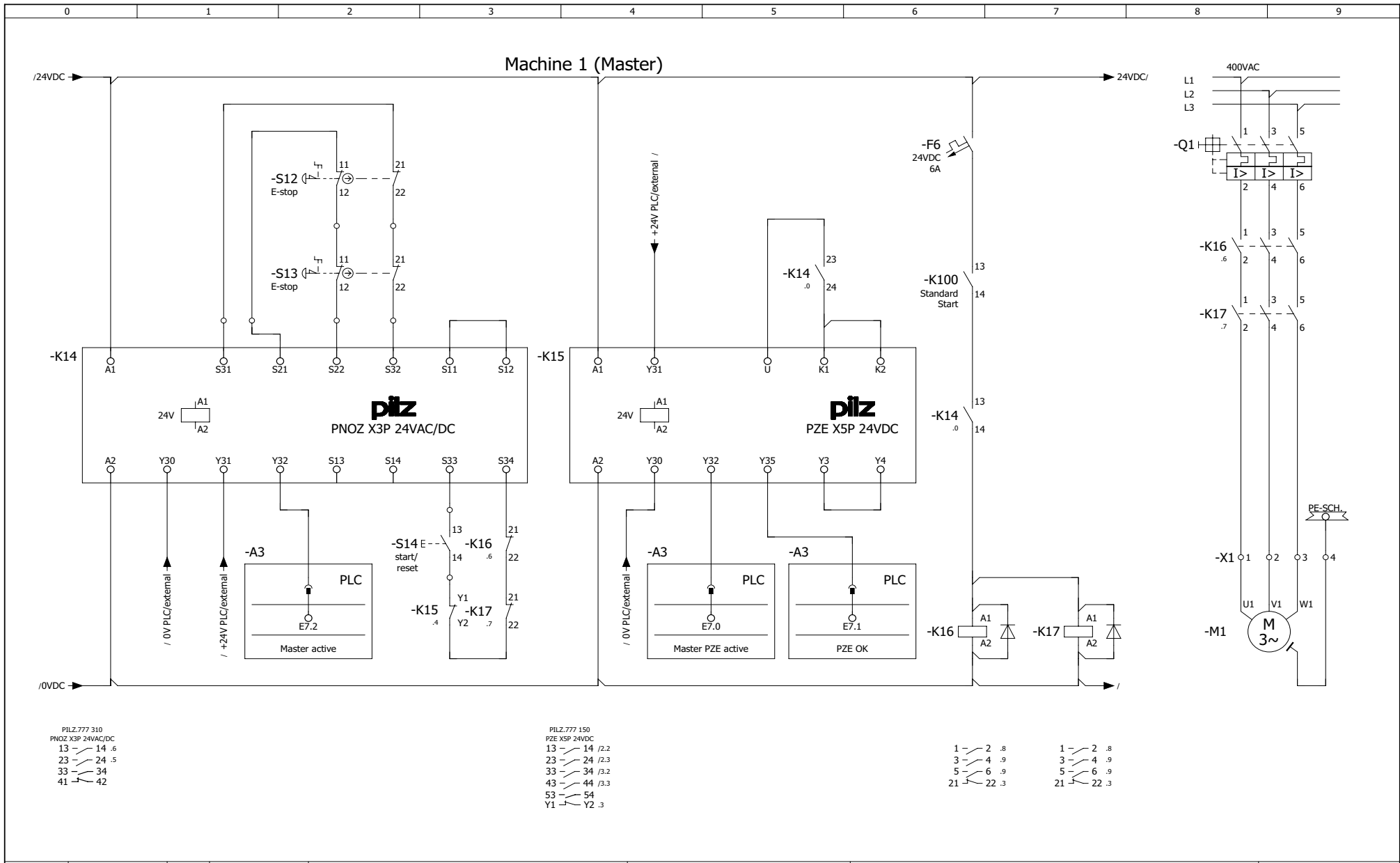

Revision	25.05.2009	Date	19.01.2005	EN ISO 13849-1:2008	PL e	 Pilz GmbH & Co. KG Felix-Wankel-Str.2 73760 Ostfildern	Interlinked machines Master Slave, galvanically isolated machine 1 (Master)	Mounting place + PNOZX3P_4	
Name	RDS	Name	RDS	EN 62061:2005	SIL 3			Page:	1 / 3
		Dep.	CS						

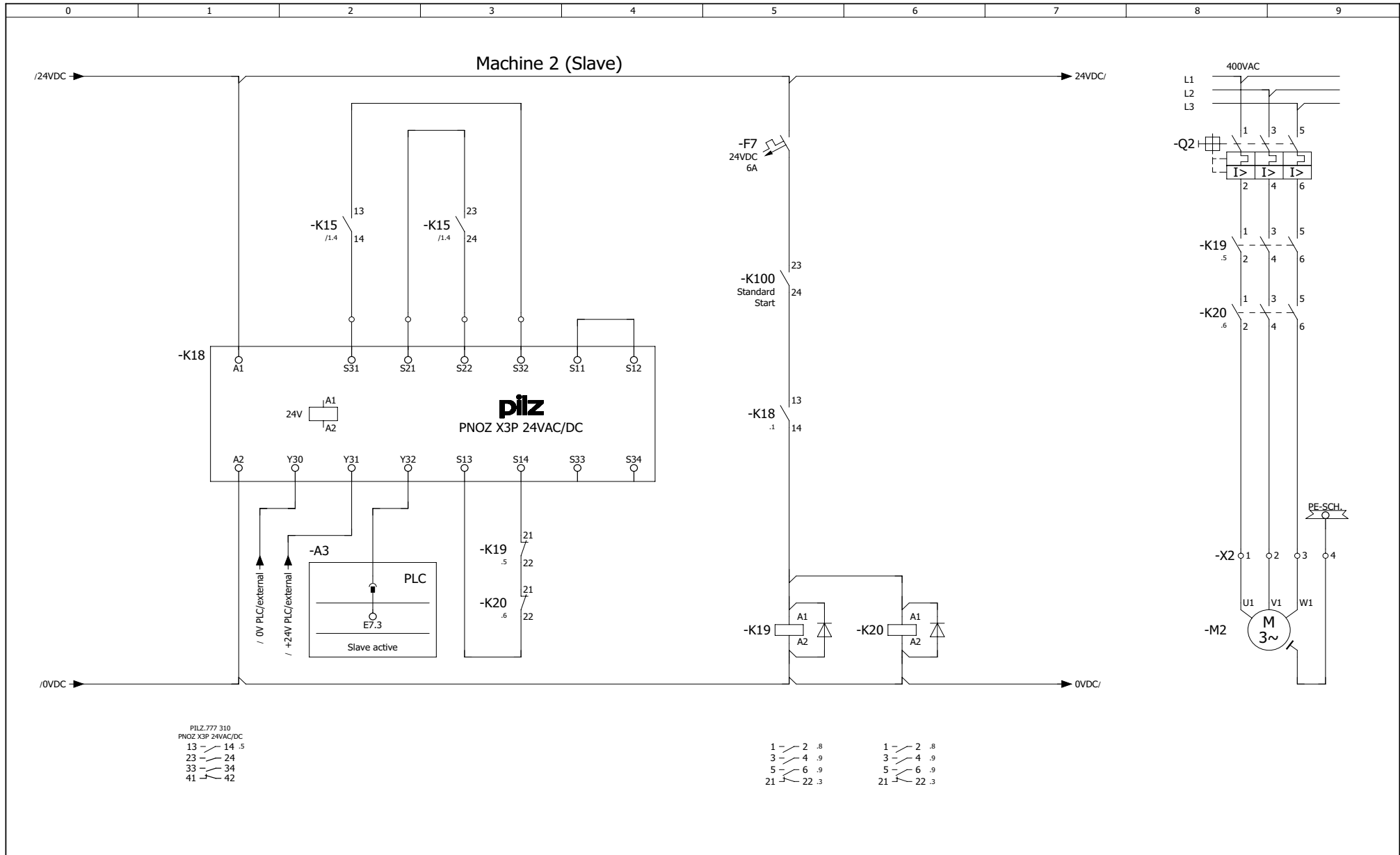

Revision	25.05.2009	Date	19.01.2005	EN ISO 13849-1:2008	PL e	 Pilz GmbH & Co.KG Felix-Wankel-Str.2 73760 Ostfildern	Interlinked machines Master Slave, galvanically isolated machine 1 (Master)	Mounting place + PNOZX3P_4
Name	RDS	Name	RDS	EN 62061:2005	SIL 3			Page:
		Dep.	CS					

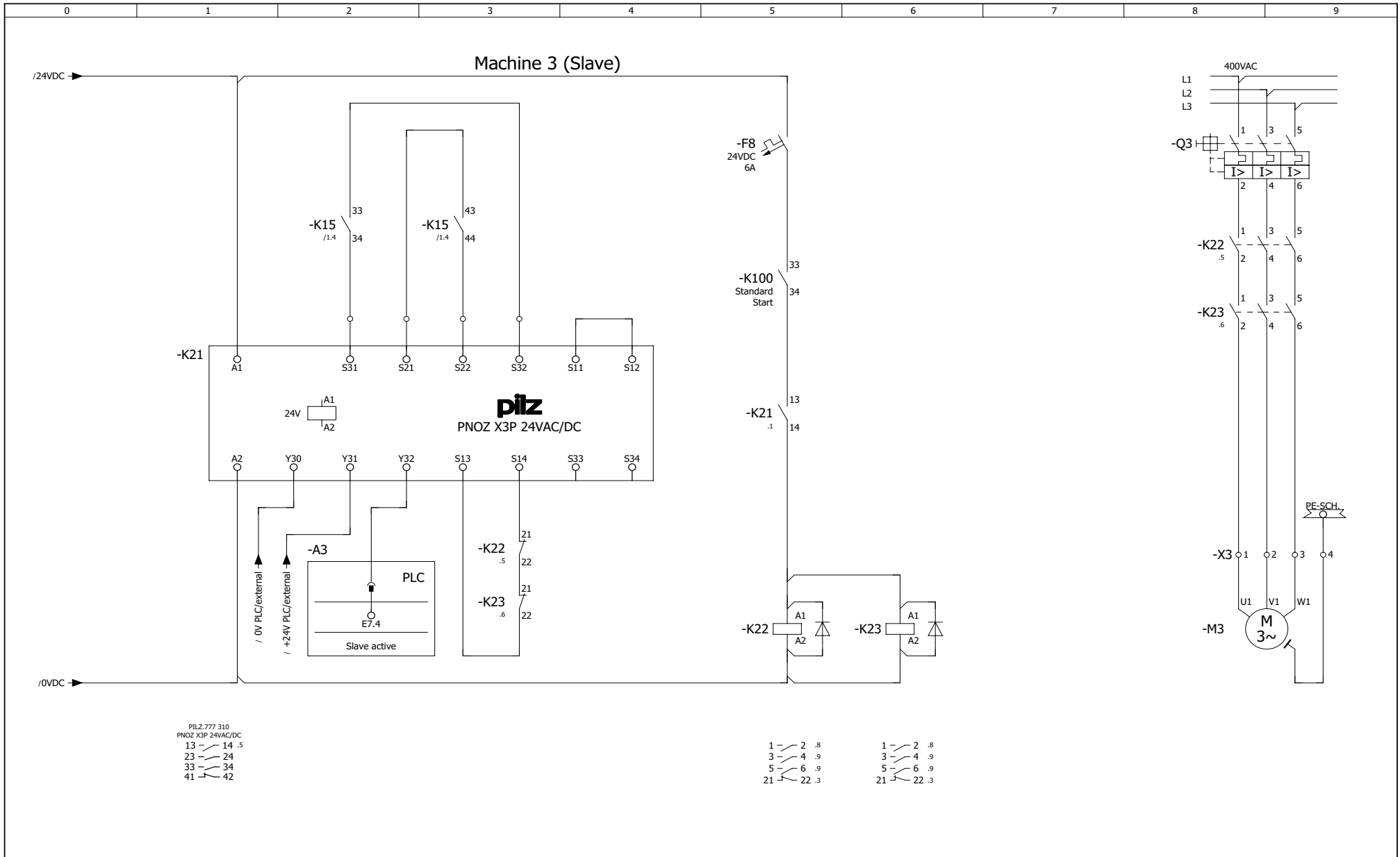

Revision	25.05.2009	Date	19.01.2005	EN ISO 13849-1:2008	PL e	Pilz GmbH & Co.KG Felix-Wankel-Str.2 73760 Ostfildern	Interlinked machines Master Slave, galvanically isolated machine 1 (Master)	Mounting place + PNOZX3P_4
Name	RDS	Name	RDS	EN 62061:2005	SIL 3			Page: 3 / 3

PL d of EN ISO 13849-1, SIL 2 of EN 62061

PNOZ X3.10P – Automatic reset after power supply failure

Features

- ▶ Dual-channel operation with detection of shorts across contacts
- ▶ Series connection of three E-STOP pushbuttons
- ▶ Automatic reset after power supply failure (voltage return)
- ▶ Manual reset after E-STOP
- ▶ Contact expansion through positive-guided contactors
- ▶ Feedback circuit to monitor contact expansion

Description

E-STOP function

When one of the E-STOP pushbuttons (S10 ... S12) is operated, the input circuit on the safety relay PNOZ X3.10P (K12) is interrupted and the safety contacts open. Contactors KM1 and KM2 de-energise. When voltage is returned (after failure of the 24 VDC supply voltage), the safety contact (momentary contact) on the safety timer PZW (K13) switches on. The safety relay PNOZ X3.10P (K12) restarts automatically. The pulse time is set via the rotary switch on the safe timer PZW (K13). The safety relay PNOZ X3.10P (K12) has a diagnostic output for display or for evaluation by a PLC.

Start/reset

The safety relay PNOZ X3.10P (K12) can be started by pressing reset button S13 if:

- ▶ E-STOP pushbuttons (S10 ... S12) have not been operated and
- ▶ Contactors KM1 and KM2 have de-energised.

Feedback circuit

The positive-guided N/C contacts on contactors KM1 and KM2 are monitored in the safety relay's reset/feedback circuit S13-S14.

Safety assessment

- ▶ The safety relay PNOZ X3.10P (K12) and contactors KM1 and KM2 must be installed in a single mounting area (control cabinet) in order to exclude a short across the output.
- ▶ Earth faults and shorts between contacts in the input circuit are detected.
- ▶ A fault on the device does not lead to the loss of the safety function.
- ▶ The device can be started if reset button S13 is closed.
- ▶ E-STOP pushbuttons may be connected in series if it's possible to predict that only one E-STOP pushbutton will be operated at a time. The category is restricted to 3 with series connection.



CAUTION!

When the supply voltage is switched on and when voltage is returned after a power failure, the outputs are activated automatically.

Pilz products

Number	Description	Order number
1	PNOZ X3.10P	777 314
1	PZW	774 042
3	PITestop Set1.1	400 410

Emergency stop applications

PL d of EN ISO 13849-1, SIL 2 of EN 62061

PNOZ X3.10P – Automatic reset after power supply failure

Safety-related characteristics in accordance with EN ISO 13849-1

Prerequisites:

- ▶ Common cause failure (CCF): Requirements are considered to be met (must be tested on implementation)
- ▶ Mission time: 20 years
- ▶ Operating interval (electromechanical components):
 - Sensor: One operation per week
 - Actuator: Three operations per week
- ▶ Characteristic data of contactors KM1, KM2: B10d: 2,000,000

EN ISO 13849-1		Performance Level	Safety-related parts of the control system
Safety function 1-3:	Machine shut down via E-STOP	PL d	Sensor (PITestop) Logic (PNOZ X3.10P K12) Logic (PZW K13) Actuator (contactors KM1, KM2)

Please note the further requirements of EN ISO 13849-1, e.g. requirements for avoiding systematic faults.

Safety-related characteristics in accordance with EN 62061

Prerequisites:

- ▶ Common cause failure (CCF): $\beta = 2 \%$ (must be tested on implementation)
- ▶ Proof test interval: 20 years
- ▶ Operating interval (electromechanical components):
 - Sensor: One operation per week
 - Actuator: Three operations per week
- ▶ Characteristic data of contactors KM1, KM2: B10d: 2,000,000
Dangerous failure rate: 65%

EN 62061		Safety Integrity Level	Subsystems
Safety-related control function (SRCF 1-3):	Machine shut down via E-STOP	SIL 2	Sensor (PITestop) Logic (PNOZ X3.10P K12) Logic (PZW K13) Actuator (contactors KM1, KM2)

Please note the further requirements of EN 62061, e.g. requirements for systematic safety integrity.

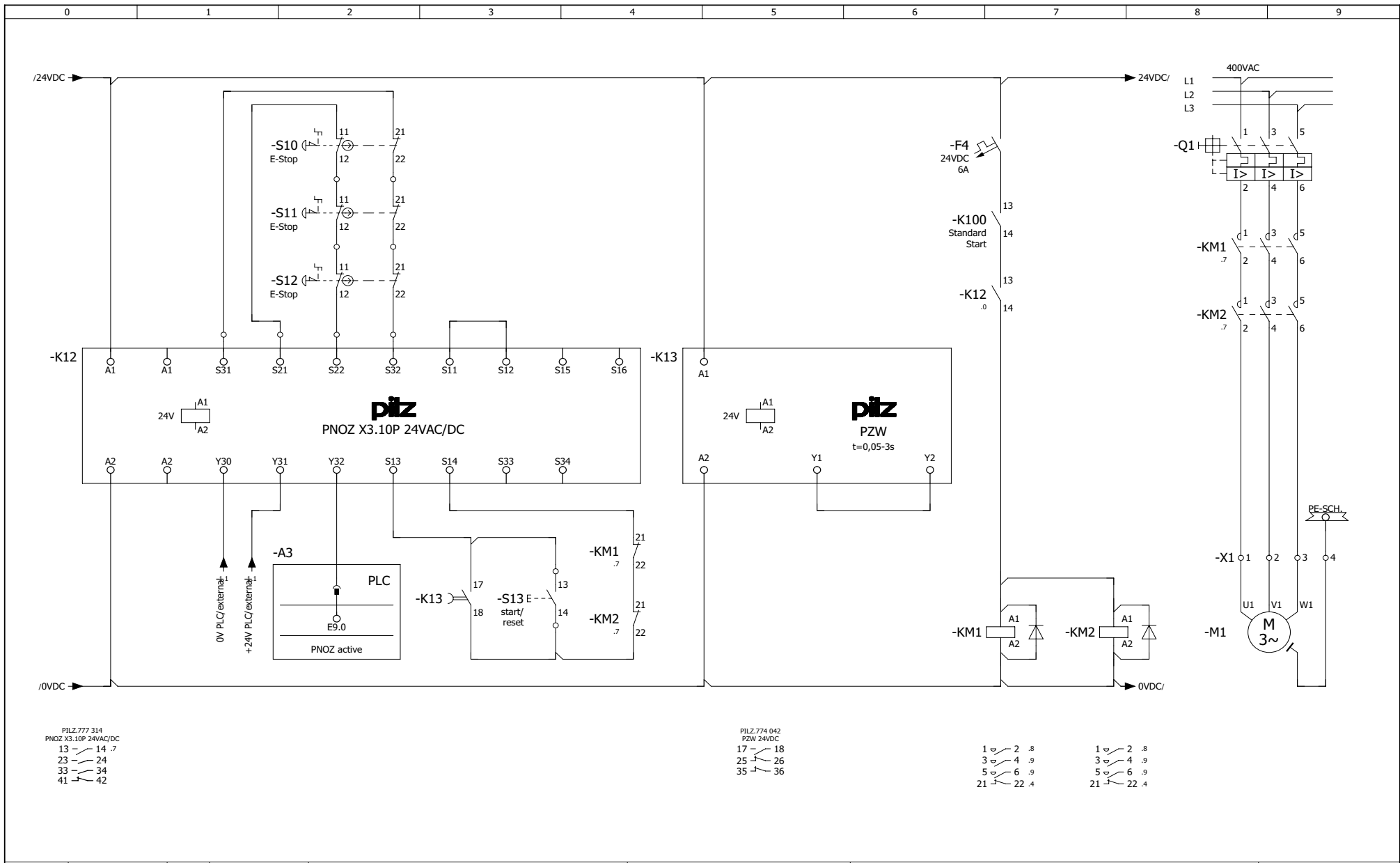

Revision	25.05.2009	Date	19.01.2005	EN ISO 13849-1:2008	PL d	 Pilz GmbH & Co.KG Felix-Wankel-Str.2 73760 Ostfildern	Emergency Stop with automatic start after power failure when used with PZW	Mounting place + PNOZX3.10P_4
Name	RDS	Name	RDS	EN 62061:2005	SIL 2			Page:
		Dep.	CS					

PL e of EN ISO 13849-1, SIL 3 of EN 62061

PNOZ X9P – Interlinked machines, galvanically isolated

Features

- ▶ Dual-channel operation with detection of shorts across contacts
- ▶ Series connection of four E-STOP pushbuttons
- ▶ Interlinked machines (Master-Slave), galvanically isolated
- ▶ Monitored reset
- ▶ Contact expansion through PZE 9P and positive-guided contactors
- ▶ Feedback circuit to monitor contact expansion

Description

E-STOP function

When one of the E-STOP pushbuttons S1, S3 ... S5 is operated, machine 1 (Master) plus machines 2 ... 4 (Slave) are stopped. When one of the E-STOP pushbuttons is operated, the input circuit on the safety relay PNOZ X9P (K1) is interrupted, the safety contacts on K1 open and contactors K2 and K3 de-energise. All the input circuits on the contact expander modules PZE 9P (K4, K7, K10) will also be interrupted due to the open safety contacts on K1 (machine 1, Master). Their safety contacts open and contactors K5, K6, K8, K9, K11 and K12 de-energise.

Start/reset

The safety relay PNOZ X9P (K1) can be started by pressing reset button S2 if:

- ▶ E-STOP pushbuttons (S1, S3 ... S5) have not been operated and
- ▶ Contactors K2 and K3 have de-energised and
- ▶ The relays on the contact expander modules PZE 9P (K4, K7, K10) have de-energised and
- ▶ Contactors K5, K6, K8, K9, K11 and K12 have de-energised.

Feedback circuit

The positive-guided N/C contacts on contactors K2, K3, K5, K6, K8, K9, K11 and K12 are monitored in feedback circuits Y1-Y2 of the respective safety relays and contact expander modules. The feedback circuits are interlinked.

Safety assessment

- ▶ The safety relay PNOZ X9P (K1) and contactors K2 and K3 must be installed in a single mounting area (control cabinet) in order to exclude a short across the output (machine 1).
- ▶ The contact expander module PZE 9P (K4) and contactors K5 and K6 must be installed in a single mounting area (control cabinet) in order to exclude a short across the output (machine 2).
- ▶ The contact expander module PZE 9P (K7) and contactors K8 and K9 must be installed in a single mounting area (control cabinet) in order to exclude a short across the output (machine 3).

- ▶ The contact expander module PZE 9P (K10) and contactors K11 and K12 must be installed in a single mounting area (control cabinet) in order to exclude a short across the output (machine 4).
- ▶ Earth faults and shorts between contacts in the input circuit are detected.
- ▶ A fault on the device does not lead to the loss of the safety function.
- ▶ The safety relay PNOZ X9P (K1) can be started when the input circuit at K1 is closed first, followed by the reset button S2. This avoids an unwanted reset before the input circuit is closed or as a result of the reset button being overridden.
- ▶ E-STOP pushbuttons may be connected in series if it's possible to predict that only one E-STOP pushbutton will be operated at a time. The category is restricted to 3 with series connection.

Pilz products

Number	Description	Order number
1	PNOZ X9P	777 609
3	PZE 9P	777 140
4	PITestop Set1.1	400 410

Emergency stop applications

PL e of EN ISO 13849-1, SIL 3 of EN 62061

PNOZ X9P – Interlinked machines, galvanically isolated

Safety-related characteristics in accordance with EN ISO 13849-1

Prerequisites:

- ▶ Common cause failure (CCF):
Requirements are considered to be met (must be tested on implementation)
- ▶ Mission time: 20 years
- ▶ Operating interval (electromechanical components):
 - Sensor: One operation per week
 - Actuator: Four operations per week
- ▶ Characteristic data of contactors K2, K3, K5, K6, K8, K9, K11, K12:
B10d: 2,000,000

EN ISO 13849-1		Performance Level	Safety-related parts of the control system
Safety function 1-4:	Machine shut down via E-STOP	PL e	Sensor (PITestop) Logic (PNOZ X9P K1) Actuator (contactors K2, K3)
Safety function 5-8:	Machine shut down via E-STOP	PL e	Sensor (PITestop) Logic (PNOZ X9P K1) Logic (PZE 9P K4) Actuator (contactors K5, K6)
Safety function 9-12:	Machine shut down via E-STOP	PL e	Sensor (PITestop) Logic (PNOZ X9P K1) Logic (PZE 9P K7) Actuator (contactors K8, K9)
Safety function 13-16:	Machine shut down via E-STOP	PL e	Sensor (PITestop) Logic (PNOZ X9P K1) Logic (PZE 9P K10) Actuator (contactors K11, K12)

Please note the further requirements of EN ISO 13849-1, e.g. requirements for avoiding systematic faults.

Emergency stop applications

PL e of EN ISO 13849-1, SIL 3 of EN 62061

PNOZ X9P – Interlinked machines, galvanically isolated

Safety-related characteristics in accordance with EN 62061

Prerequisites:

- ▶ Common cause failure (CCF): $\beta = 2 \%$ (must be tested on implementation)
- ▶ Proof test interval: 20 years
- ▶ Operating interval (electromechanical components):
 - Sensor: One operation per week
 - Actuator: Four operations per week
- ▶ Characteristic data of contactors K2, K3, K5, K6, K8, K9, K11, K12:
 - B10d: 2,000,000
 - Dangerous failure rate: 65%

EN 62061		Safety Integrity Level	Subsystems
Safety-related control function (SRCF 1-4):	Machine shut down via E-STOP	SIL 3	Sensor (PITestop) Logic (PNOZ X9P K1) Actuator (contactors K2, K3)
Safety-related control function (SRCF 5-8):	Machine shut down via E-STOP	SIL 3	Sensor (PITestop) Logic (PNOZ X9P K1) Logic (PZE 9P K4) Actuator (contactors K5, K6)
Safety-related control function (SRCF 9-12):	Machine shut down via E-STOP	SIL 3	Sensor (PITestop) Logic (PNOZ X9P K1) Logic (PZE 9P K7) Actuator (contactors K8, K9)
Safety-related control function (SRCF 13-16):	Machine shut down via E-STOP	SIL 3	Sensor (PITestop) Logic (PNOZ X9P K1) Logic (PZE 9P K10) Actuator (contactors K11, K12)

Please note the further requirements of EN 62061, e.g. requirements for systematic safety integrity.

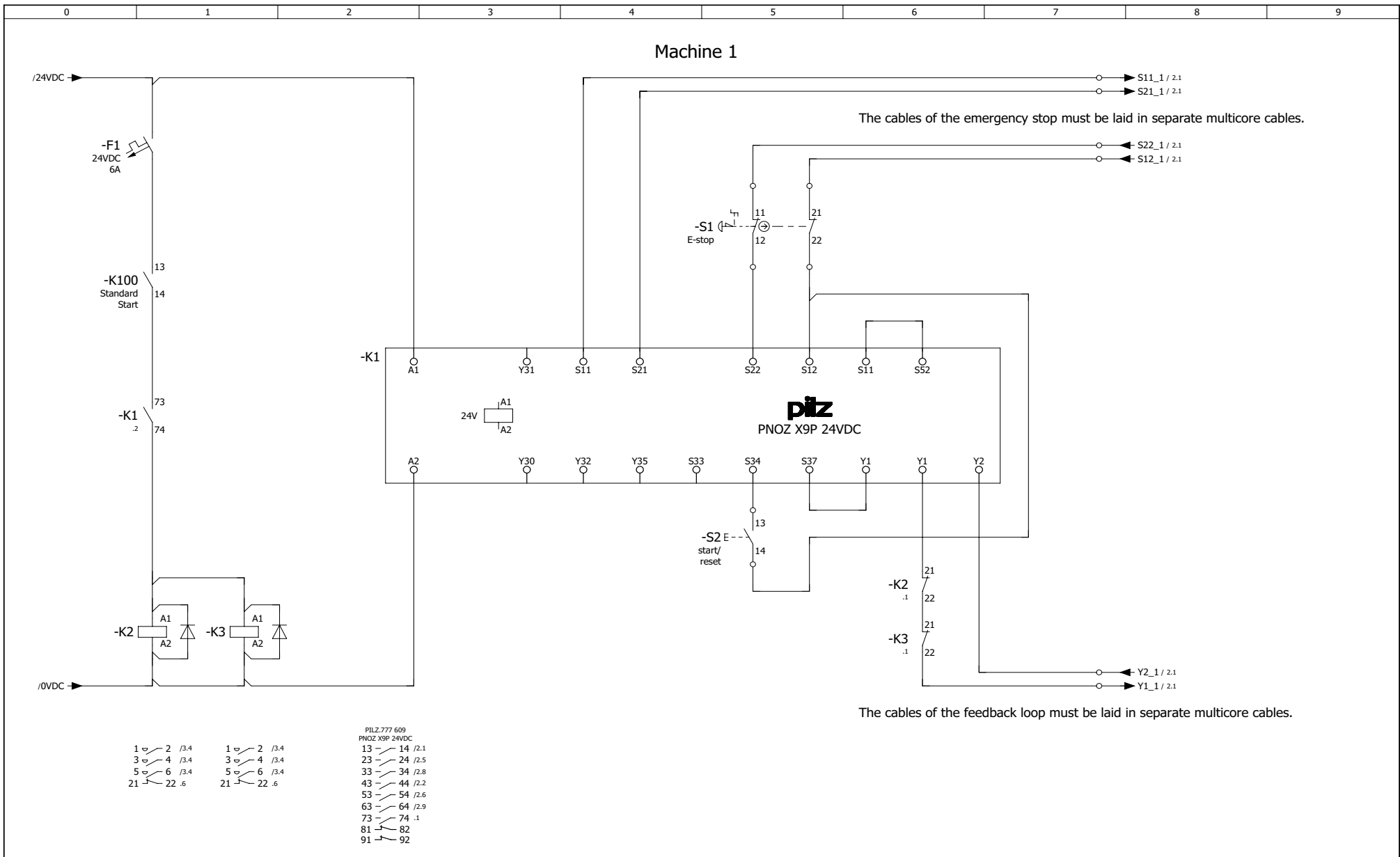

Revision	25.05.2009	Date	19.01.2005	EN ISO 13849-1:2008	PL e	Pilz GmbH & Co.KG Felix-Wankel-Str.2 73760 Ostfildern	Emergency Stop 2-channel machines galvanically isolated Master Slave with PZE	Mounting place + PNOZX9P
Name	RDS	Name	WED	EN 62061:2005	SIL 3		Page:	1 / 3
		Dep.	CS					

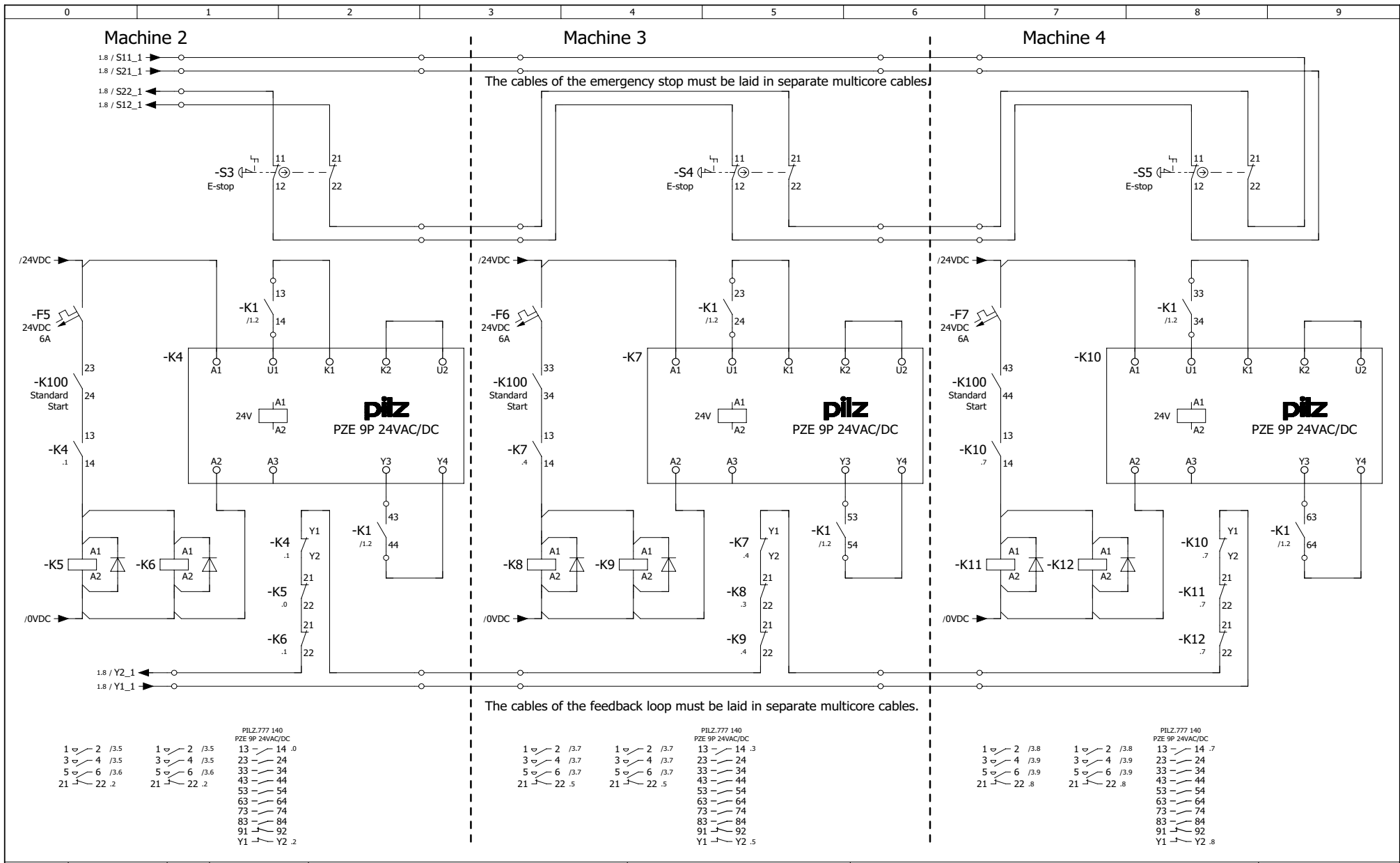

Revision	25.05.2009	Date	19.01.2005	EN ISO 13849-1:2008	PL e	 Pilz GmbH & Co.KG Felix-Wankel-Str.2 73760 Ostfildern	Emergency Stop 2-channel machines galvanically isolated Master Slave with PZE	Mounting place + PNOZX9P
Name	RDS	Name	RDS	EN 62061:2005	SIL 3			Page:

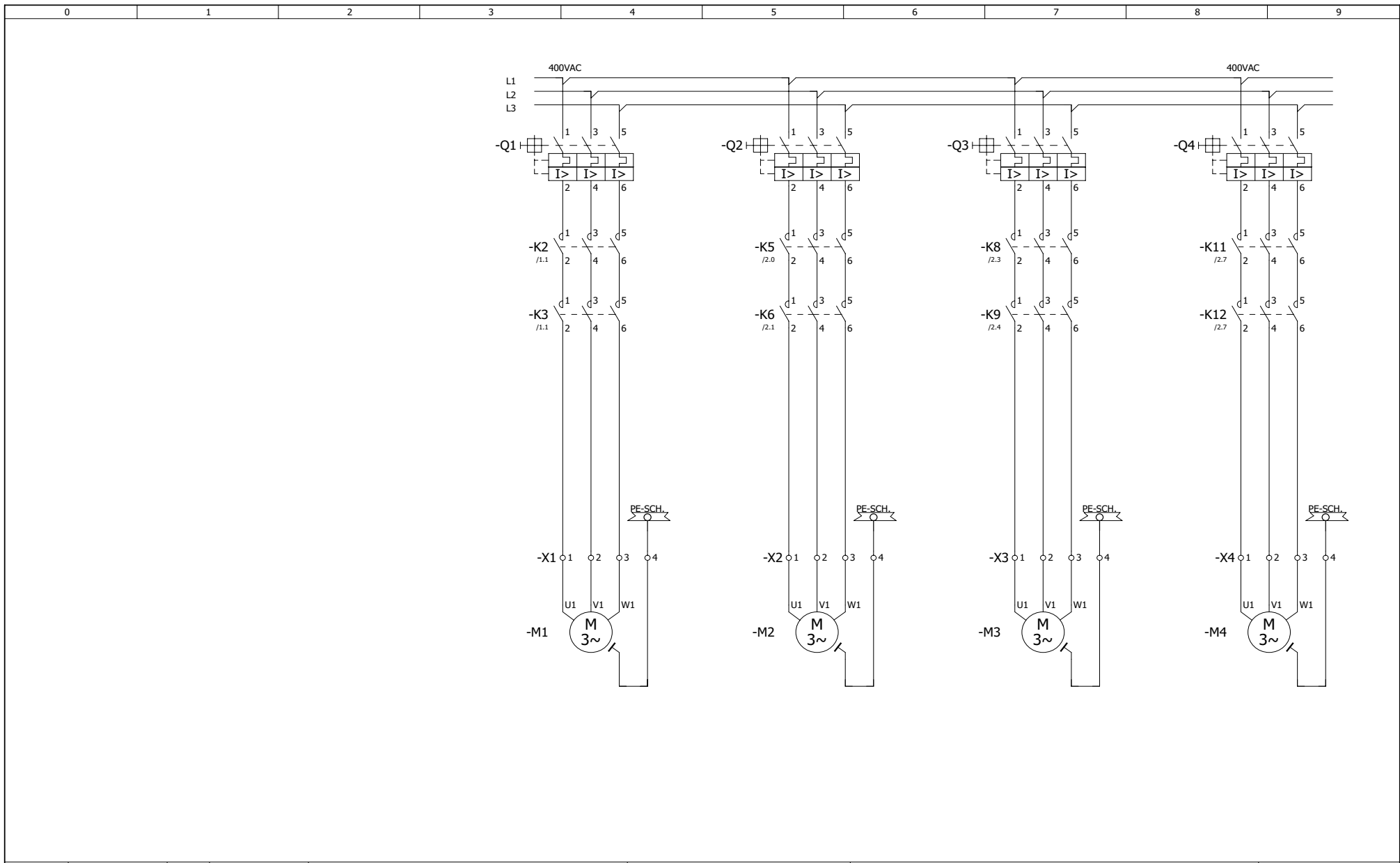

Revision	25.05.2009	Date	19.01.2005	EN ISO 13849-1:2008	PL e	 Pilz GmbH & Co.KG Felix-Wankel-Str.2 73760 Ostfildern	Emergency Stop 2-channel machines galvanically isolated Master Slave with PZE	Mounting place + PNOZX9P
Name	RDS	Name	RDS	EN 62061:2005	SIL 3			Page:
		Dep.	CS					

PL e of EN ISO 13849-1, SIL 3 of EN 62061

PNOZ X10.11P – Interlinked machines, galvanically isolated

Features

- ▶ Dual-channel operation with detection of shorts across contacts
- ▶ Monitored reset
- ▶ Interlinked machines, galvanically isolated
- ▶ Separate reset on each machine
- ▶ Contact expansion through positive-guided contactors
- ▶ Feedback circuit to monitor contact expansion

Description

E-STOP function

When the E-STOP pushbutton (S12) is operated, the input circuit on the safety relay PNOZ X10.11P (K14, machine 1) is interrupted, the safety contacts on K14 open. The input circuit on the safety relay PNOZ X10.11P (K15, machine 1) is interrupted, the safety contacts on K15 open and contactors K16 and K17 de-energise. The input circuit on the safety relay PNOZ X10.11P (K19, machine 2) is interrupted, the safety contacts on K19 open and contactors K20 and K21 de-energise.

When the E-STOP pushbutton (S14) is operated, the input circuit on the safety relay PNOZ X10.11P (K18, machine 2) is interrupted, the safety contacts on K18 open. The input circuit on the safety relay PNOZ X10.11P (K19, machine 2) is interrupted, the safety contacts on K19 open

and contactors K20 and K21 de-energise. The input circuit on the safety relay PNOZ X10.11P (K15, machine 1) is interrupted, the safety contacts on K15 open and contactors K16 and K17 de-energise.

Start/reset

The safety relay PNOZ X10.11P (K14) can be started by pressing reset button S13 if E-STOP pushbutton S12 has not been operated.

The safety relay PNOZ X10.11P (K15) is started automatically if the safety contacts on K14 (machine 1) and K18 (machine 2) are closed and contactors K16 and K17 have de-energised.

The safety relay PNOZ X10.11P (K18) can be started by pressing reset button S15 if E-STOP pushbutton S14 has not been operated. The safety relay PNOZ X10.11P (K19) is started automatically if the safety contacts on K18 (machine 2) and K14 (machine 1) are closed and contactors K20 and K21 have de-energised.

Feedback circuit

The positive-guided N/C contacts on contactors K16, K17 and K20, K21 are monitored in feedback circuits Y1-Y2 of the respective safety relays.

Safety assessment

- ▶ The safety relay PNOZ X10.11P (K15) and contactors K16 and K17 must be installed in a single mounting area (control cabinet) in order to exclude a short across the output (machine 1).
- ▶ The safety relay PNOZ X10.11P (K19) and contactors K20 and K21 must be installed in a single mounting area (control cabinet) in order to exclude a short across the output (machine 2).
- ▶ Earth faults and shorts between contacts in the input circuit are detected.
- ▶ A fault on the device does not lead to the loss of the safety function.
- ▶ The safety relay PNOZ X10.11P (K14) can be started if the input circuit at K14 is closed first, followed by the reset button S13.
The safety relay PNOZ X10.11P (K18) can be started if the input circuit at K18 is closed first, followed by the reset button S15. This avoids an unwanted reset before the input circuit is closed or as a result of the reset button being overridden.

Pilz products

Number	Description	Order number
4	PNOZ X10.11P	777 750
2	PITestop Set1.1	400 410

Emergency stop applications

PL e of EN ISO 13849-1, SIL 3 of EN 62061

PNOZ X10.11P – Interlinked machines, galvanically isolated

Safety-related characteristics in accordance with EN ISO 13849-1

Prerequisites:

- ▶ Common cause failure (CCF):
Requirements are considered to be met (must be tested on implementation)
- ▶ Mission time: 20 years
- ▶ Operating interval (electromechanical components):
 - Sensor: One operation per week
 - Actuator: Two operations per week
- ▶ Characteristic data of contactors K16, K17, K20, K21:
B10d: 2,000,000

EN ISO 13849-1		Performance Level	Safety-related parts of the control system
Safety function 1:	Machine shut down via E-STOP	PL e	Sensor (PITestop S12) Logic (PNOZ X10.11P K14) Logic (PNOZ X10.11P K15) Actuator (contactors K16, K17)
Safety function 2:	Machine shut down via E-STOP	PL e	Sensor (PITestop S12) Logic (PNOZ X10.11P K14) Logic (PNOZ X10.11P K19) Actuator (contactors K20, K21)
Safety function 3:	Machine shut down via E-STOP	PL e	Sensor (PITestop S14) Logic (PNOZ X10.11P K18) Logic (PNOZ X10.11P K19) Actuator (contactors K20, K21)
Safety function 4:	Machine shut down via E-STOP	PL e	Sensor (PITestop S14) Logic (PNOZ X10.11P K18) Logic (PNOZ X10.11P K15) Actuator (contactors K16, K17)

Please note the further requirements of EN ISO 13849-1, e.g. requirements for avoiding systematic faults.

Emergency stop applications

PL e of EN ISO 13849-1, SIL 3 of EN 62061

PNOZ X10.11P – Interlinked machines, galvanically isolated

Safety-related characteristics in accordance with EN 62061

Prerequisites:

- ▶ Common cause failure (CCF): $\beta = 2 \%$ (must be tested on implementation)
- ▶ Proof test interval: 20 years
- ▶ Operating interval (electromechanical components):
 - Sensor: One operation per week
 - Actuator: Two operations per week
- ▶ Characteristic data of contactors K16, K17, K20, K21:
B10d: 2,000,000
Dangerous failure rate: 65%

EN 62061	Safety Integrity Level	Subsystems
Safety-related control function (SRCF 1): Machine shut down via E-STOP	SIL 3	Sensor (PITestop S12) Logic (PNOZ X10.11P K14) Logic (PNOZ X10.11P K15) Actuator (contactors K16, K17)
Safety-related control function (SRCF 2): Machine shut down via E-STOP	SIL 3	Sensor (PITestop S12) Logic (PNOZ X10.11P K14) Logic (PNOZ X10.11P K19) Actuator (contactors K20, K21)
Safety-related control function (SRCF 3): Machine shut down via E-STOP	SIL 3	Sensor (PITestop S14) Logic (PNOZ X10.11P K18) Logic (PNOZ X10.11P K19) Actuator (contactors K20, K21)
Safety-related control function (SRCF 4): Machine shut down via E-STOP	SIL 3	Sensor (PITestop S14) Logic (PNOZ X10.11P K18) Logic (PNOZ X10.11P K15) Actuator (contactors K16, K17)

Please note the further requirements of EN 62061, e.g. requirements for systematic safety integrity.

Classification in accordance with EN 954-1

Depending on the application area and its respective regulations, this connection example is suitable for applications up to Category 4 of EN 954-1.

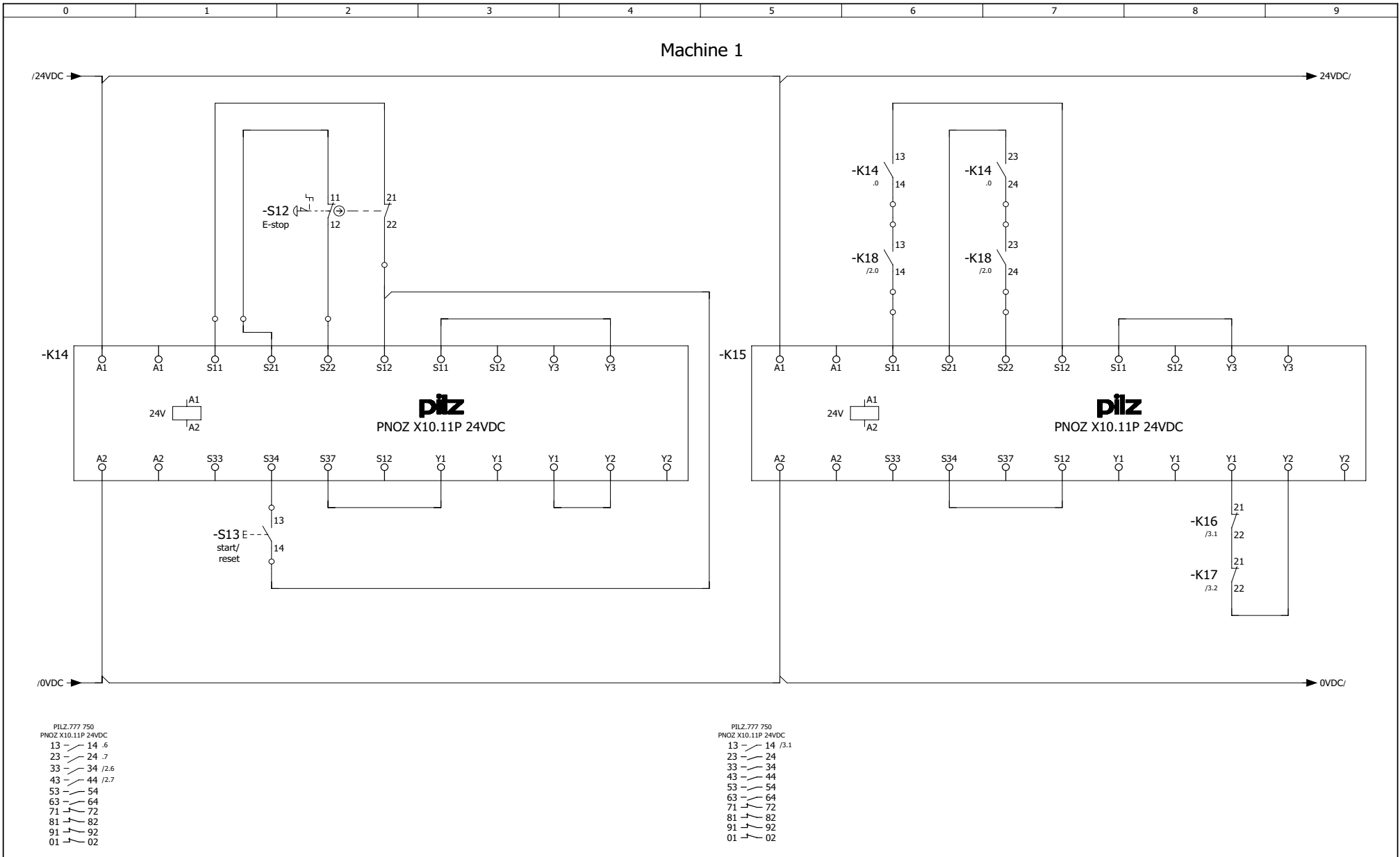

Revision	25.05.2009	Date	19.01.2005	EN ISO 13849-1:2008	PL e	pilz Pilz GmbH & Co.KG Felix-Wankel-Str.2 73760 Ostfildern	Emergency Stop machines galvanically isolated	Mounting place + PNOZX10.11P_2
Name	RDS	Name	RDS	EN 62061:2005	SIL 3			Page: 1 / 3
		Dep.	CS					

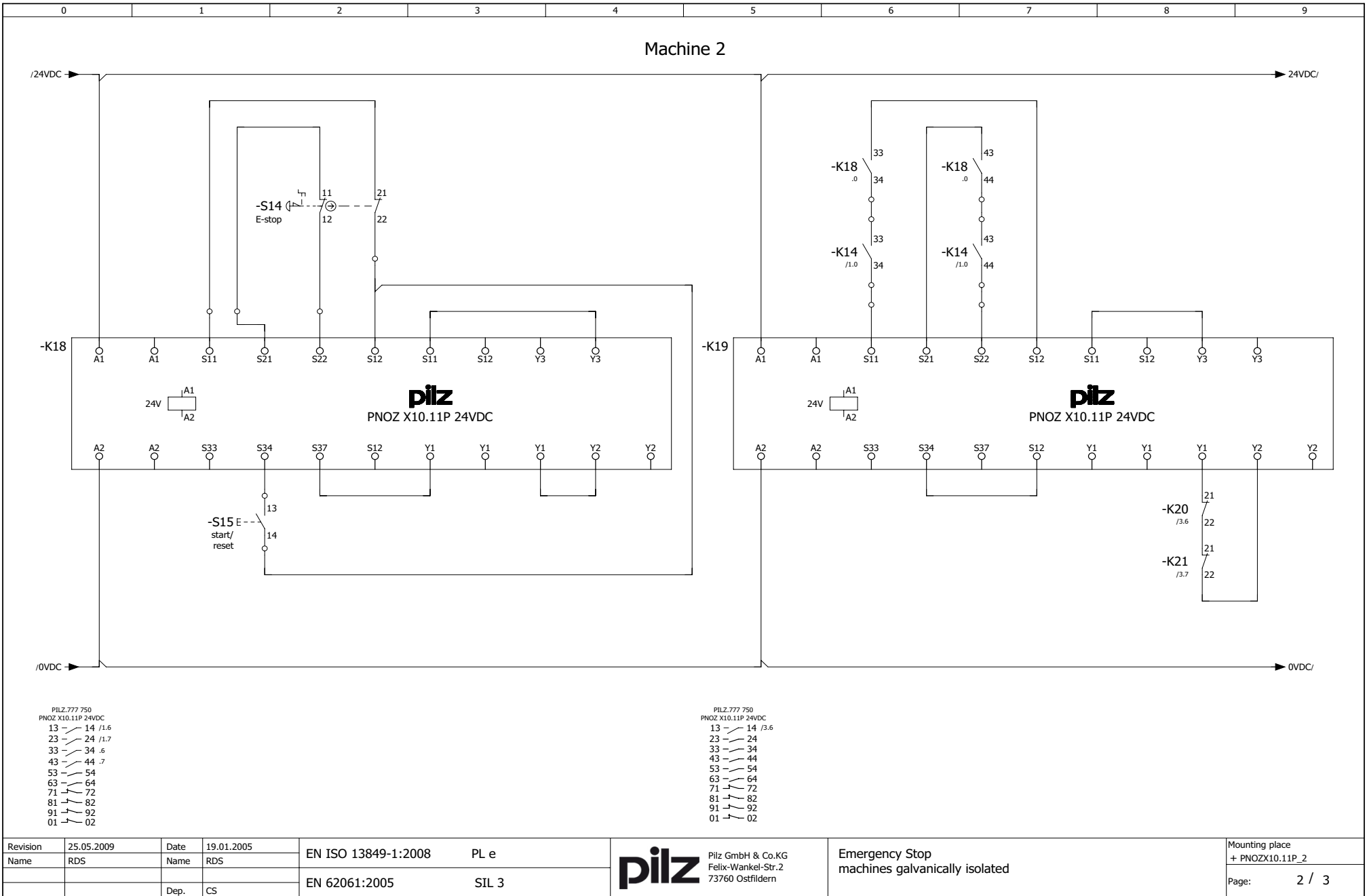

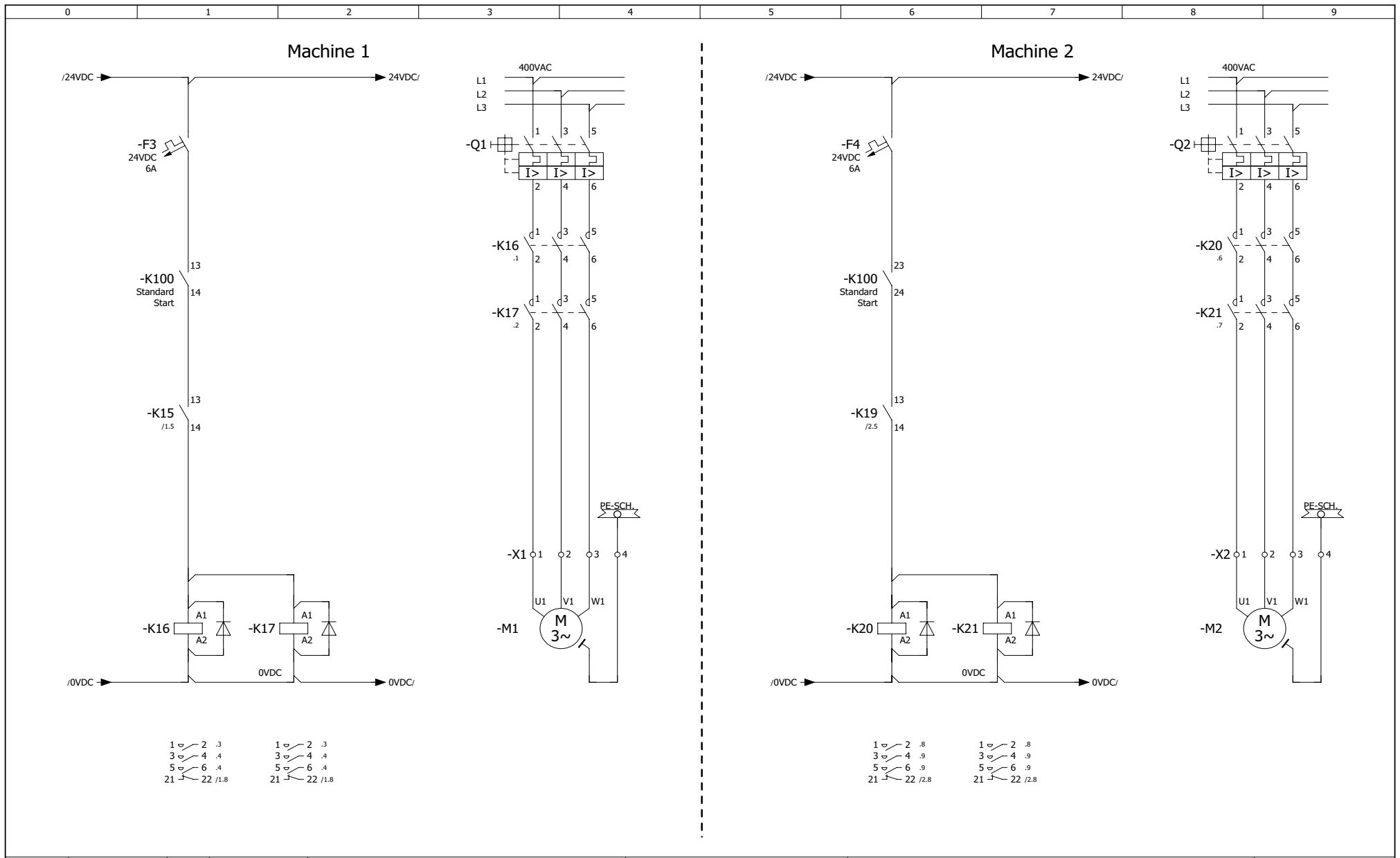

Revision	25.05.2009	Date	19.01.2005	EN ISO 13849-1:2008	PL e	 Pilz GmbH & Co.KG Felix-Wankel-Str.2 73760 Ostfildern	Emergency Stop machines galvanically isolated	Mounting place + PNOZX10.11P_2
Name	RDS	Name	RDS	EN 62061:2005	SIL 3			Page:

PL e of EN ISO 13849-1, SIL 3 of EN 62061

PNOZ X10.11P – Interlinked machines, galvanically isolated

Features

- ▶ Dual-channel operation with detection of shorts across contacts
- ▶ Series connection of four E-STOP pushbuttons
- ▶ Interlinked machines (Master-Slave), galvanically isolated
- ▶ Monitored reset
- ▶ Contact expansion through PZE 9P and positive-guided contactors
- ▶ Feedback circuit to monitor contact expansion

Description

E-STOP function

When one of the E-STOP pushbuttons (S16, S18 ... S20) is operated, machine 1 (Master) plus machines 2 ... 4 (Slave) are stopped. When one of the E-STOP pushbuttons is operated, the input circuit on the safety relay PNOZ X10.11P (K25) is interrupted, the safety contacts on K25 open and contactors K27 and K28 de-energise. All the input circuits on the contact expander modules PZE 9P (K26, K29, K32 and K35) will also be interrupted due to the open safety contacts on K1 (machine 1, Master). Their safety contacts open and contactors K30, K31, K33, K34, K36 and K37 de-energise.

Start/reset

The safety relay PNOZ X10.11P (K25) can be started by pressing reset button S17 if:

- ▶ E-STOP pushbuttons (S16, S18 .. S20) have not been operated and
- ▶ Contactors K27 and K28 have de-energised and
- ▶ The relays on the contact expander modules PZE 9P (K26, K29, K32, K35) have de-energised and
- ▶ Contactors K30, K31, K33, K34, K36 and K37 have de-energised.

Feedback circuit

The positive-guided N/C contacts on contactors K27, K28, K30, K31, K33, K34, K36 and K37 are monitored in feedback circuits Y1-Y2 of the respective safety relays and contact expander modules. The feedback circuits are interlinked.

Safety assessment

- ▶ The safety relay PNOZ X10.11P (K25) and contactors K27 and K28 must be installed in a single mounting area (control cabinet) in order to exclude a short across the output (machine 1).
- ▶ The contact expander module PZE 9P (K29) and contactors K30 and K31 must be installed in a single mounting area (control cabinet) in order to exclude a short across the output (machine 2).
- ▶ The contact expander module PZE 9P (K32) and contactors K33 and K34 must be installed in a single mounting area (control cabinet) in order to exclude a short across the output (machine 3).

- ▶ The contact expander module PZE 9P (K35) and contactors K36 and K37 must be installed in a single mounting area (control cabinet) in order to exclude a short across the output (machine 4).
- ▶ Earth faults and shorts between contacts in the input circuit are detected.
- ▶ A fault on the device does not lead to the loss of the safety function.
- ▶ The safety relay PNOZ X10.11P (K25) can be started when the input circuit is closed first, followed by reset button S17. This avoids an unwanted reset before the input circuit is closed or as a result of the reset button being overridden.
- ▶ E-STOP pushbuttons may be connected in series if it's possible to predict that only one E-STOP pushbutton will be operated at a time. The category is restricted to 3 with series connection.

Pilz products

Number	Description	Order number
1	PNOZ X10.11P	777 750
4	PZE 9P	777 140
4	PITestop Set1.1	400 410

Emergency stop applications

PL e of EN ISO 13849-1, SIL 3 of EN 62061

PNOZ X10.11P – Interlinked machines, galvanically isolated

Safety-related characteristics in accordance with EN ISO 13849-1

Prerequisites:

- ▶ Common cause failure (CCF):
Requirements are considered to be met (must be tested on implementation)
- ▶ Mission time: 20 years
- ▶ Operating interval (electromechanical components):
 - Sensor: One operation per week
 - Actuator: Four operations per week
- ▶ Characteristic data of contactors K27, K28, K30, K31, K33, K34, K36, K37: B10d: 2,000,000

EN ISO 13849-1		Performance Level	Safety-related parts of the control system
Safety function 1-4:	Machine shut down via E-STOP	PL e	Sensor (PITestop) Logic (PNOZ X10.11P K25) Actuator (contactors K27, K28)
Safety function 5-8:	Machine shut down via E-STOP	PL e	Sensor (PITestop) Logic (PNOZ X10.11P K25) Logic (PZE 9P K29) Actuator (contactors K30, K31)
Safety function 9-12:	Machine shut down via E-STOP	PL e	Sensor (PITestop) Logic (PNOZ X10.11P K25) Logic (PZE 9P K26) Logic (PZE 9P K32) Actuator (contactors K33, K34)
Safety function 13-16:	Machine shut down via E-STOP	PL e	Sensor (PITestop) Logic (PNOZ X10.11P K25) Logic (PZE 9P K26) Logic (PZE 9P K35) Actuator (contactors K36, K37)

Please note the further requirements of EN ISO 13849-1, e.g. requirements for avoiding systematic faults.

Emergency stop applications

PL e of EN ISO 13849-1, SIL 3 of EN 62061

PNOZ X10.11P – Interlinked machines, galvanically isolated

Safety-related characteristics in accordance with EN 62061

Prerequisites:

- ▶ Common cause failure (CCF): $\beta = 2 \%$ (must be tested on implementation)
- ▶ Proof test interval: 20 years
- ▶ Operating interval (electromechanical components):
 - Sensor: One operation per week
 - Actuator: Four operations per week
- ▶ Characteristic data of contactors K27, K28, K30, K31, K33, K34, K36, K37: B10d: 2,000,000
- Dangerous failure rate: 65%

EN 62061		Safety Integrity Level	Subsystems
Safety-related control function (SRCF 1-4):	Machine shut down via E-STOP	SIL 3	Sensor (PITestop) Logic (PNOZ X10.11P K25) Actuator (contactors K27, K28)
Safety-related control function (SRCF 5-8):	Machine shut down via E-STOP	SIL 3	Sensor (PITestop) Logic (PNOZ X10.11P K25) Logic (PZE 9P K29) Actuator (contactors K30, K31)
Safety-related control function (SRCF 9-12):	Machine shut down via E-STOP	SIL 3	Sensor (PITestop) Logic (PNOZ X10.11P K25) Logic (PZE 9P K26) Logic (PZE 9P K32) Actuator (contactors K33, K34)
Safety-related control function (SRCF 13-16):	Machine shut down via E-STOP	SIL 3	Sensor (PITestop) Logic (PNOZ X10.11P K25) Logic (PZE 9P K26) Logic (PZE 9P K35) Actuator (contactors K36, K37)

Please note the further requirements of EN 62061, e.g. requirements for systematic safety integrity.

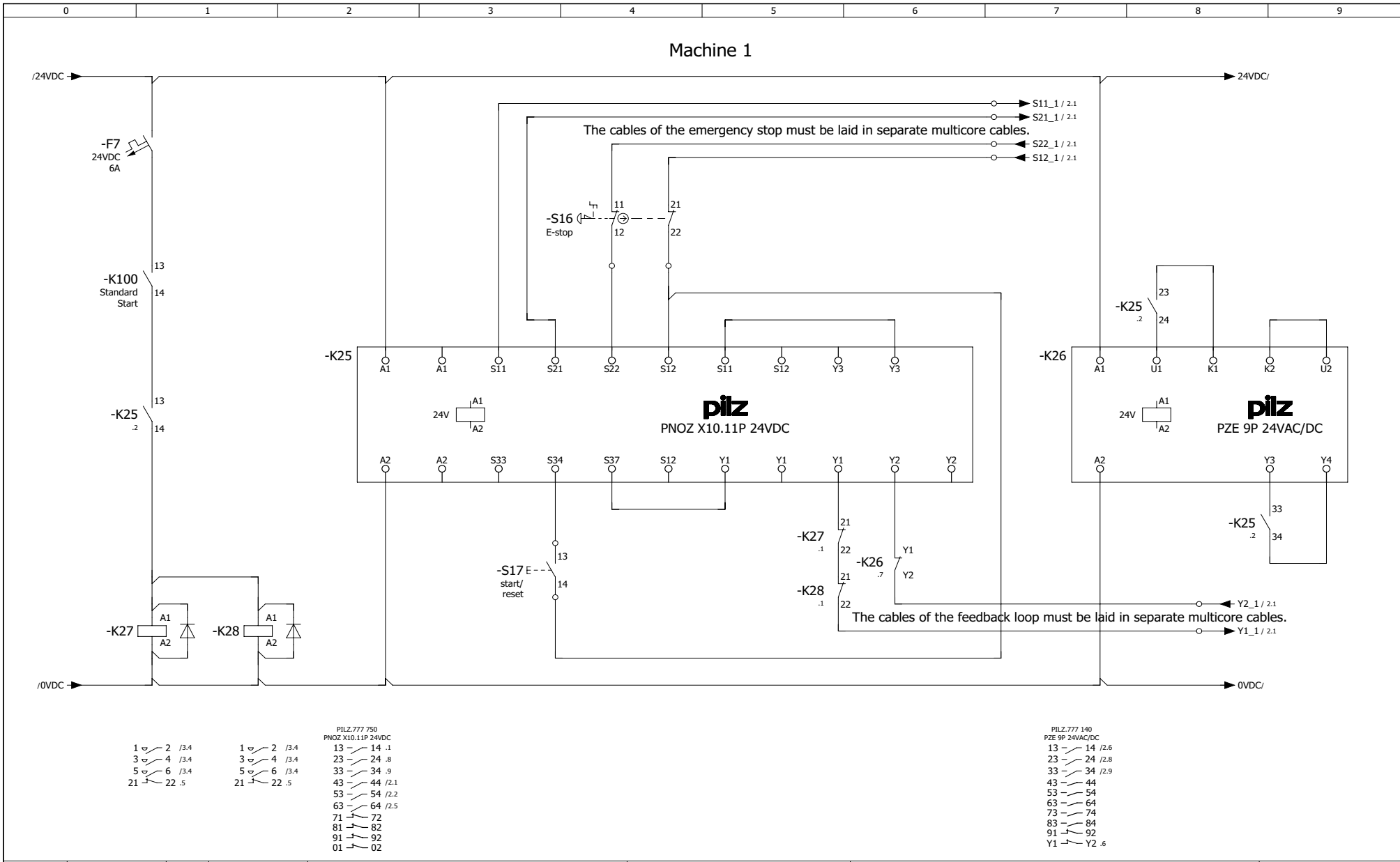

Revision	25.05.2009	Date	19.01.2005	EN ISO 13849-1:2008	PL e	pilz Pilz GmbH & Co.KG Felix-Wankel-Str.2 73760 Ostfildern	Interlinked machines Master Slave with PZE, E-Stop circuit not galvanically isolated	Mounting place + PNOZX10.11P_3
Name	RDS	Name	RDS	EN 62061:2005	SIL 3			Page:
		Dep.	CS					

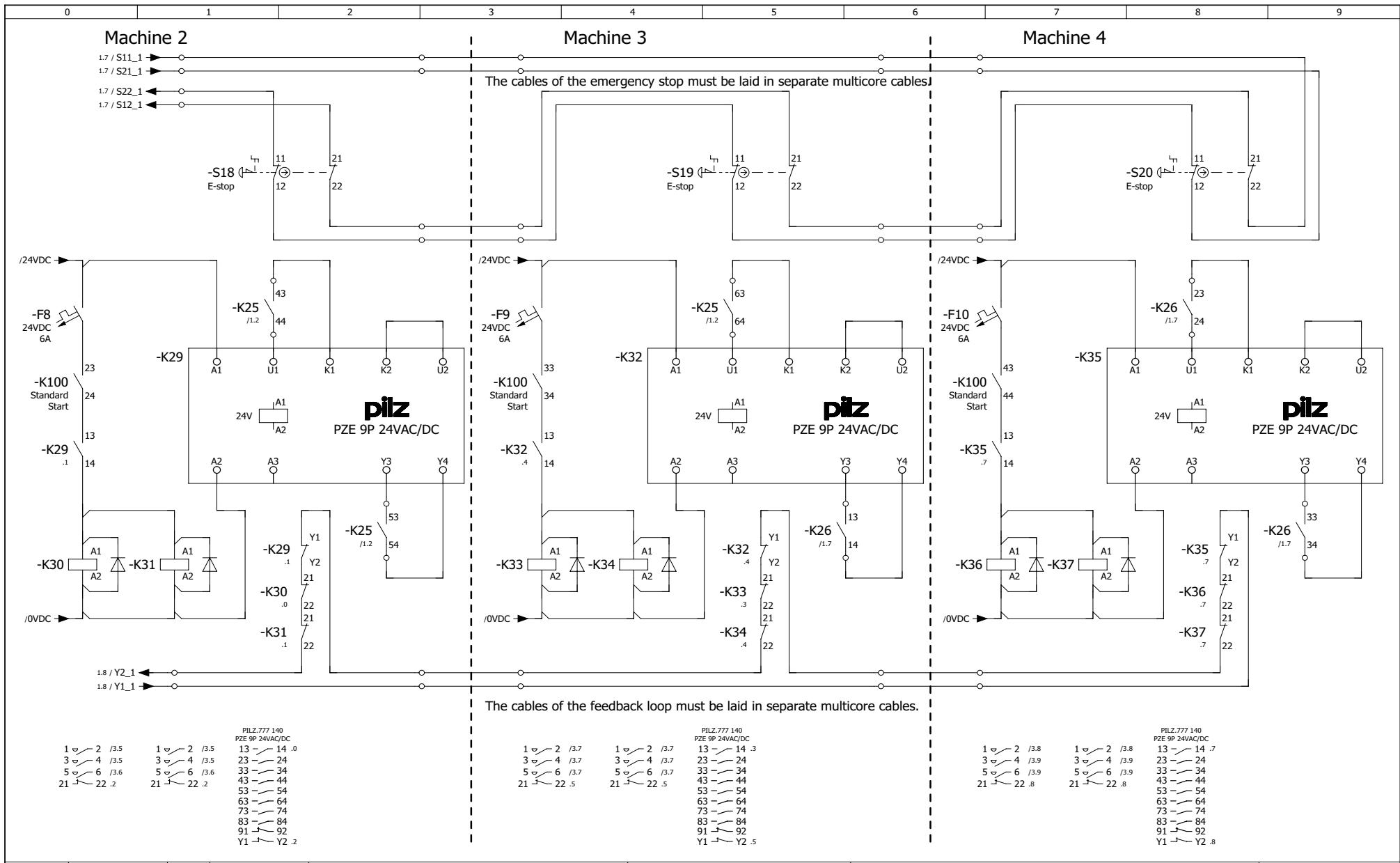

Revision	25.05.2009	Date	19.01.2005	EN ISO 13849-1:2008	PL e	Pilz GmbH & Co. KG Felix-Wankel-Str.2 73760 Ostfildern	Interlinked machines Master Slave with PZE, E-Stop circuit not galvanically isolated	Mounting place	+ PNOZX10.11P_3
Name	RDS	Name	RDS	EN 62061:2005	SIL 3			Page:	2 / 3

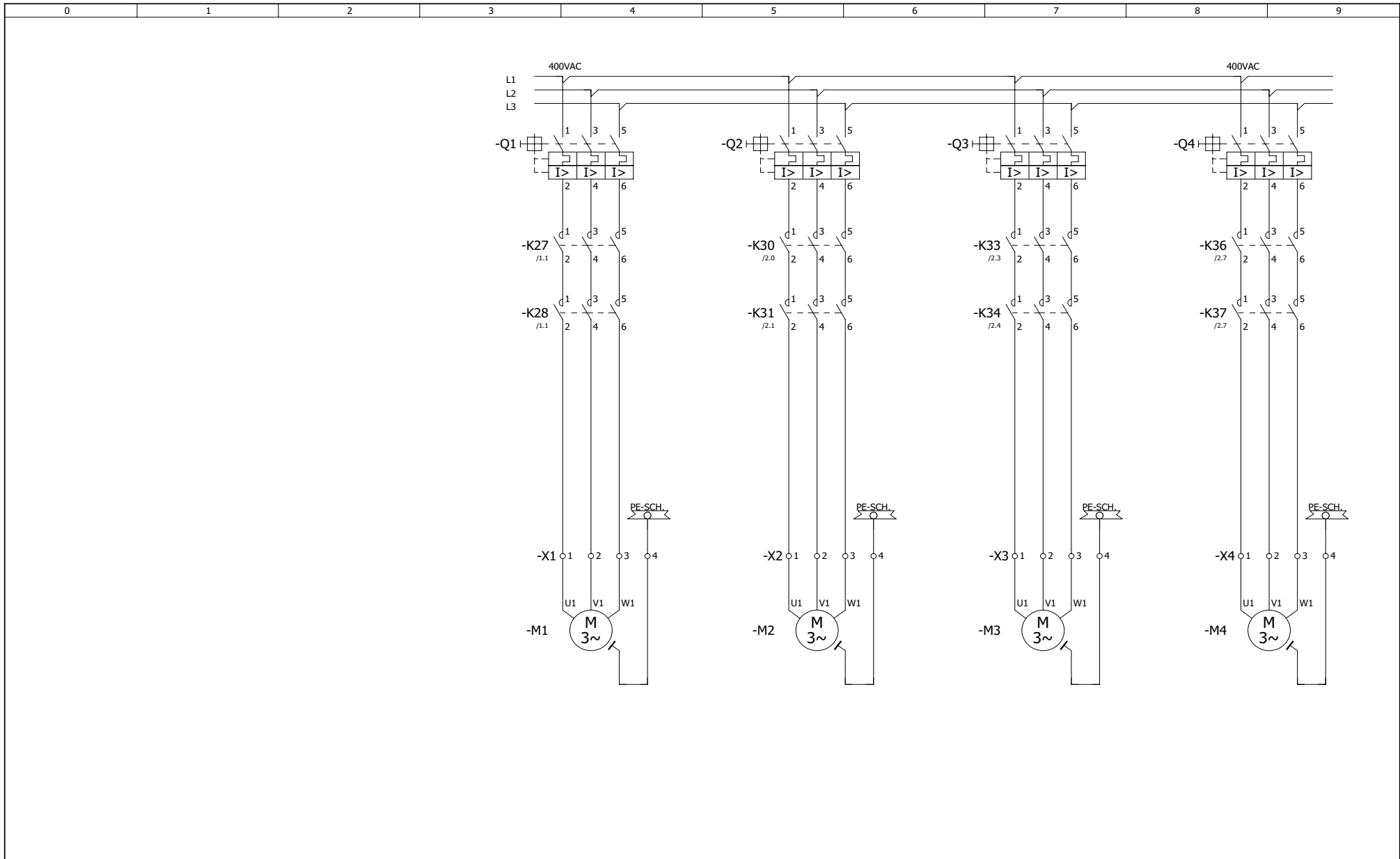

Revision	25.05.2009	Date	19.01.2005	EN ISO 13849-1:2008	PL e	 Pilz GmbH & Co. KG Felix-Wankel-Str.2 73760 Ostfildern	Interlinked machines Master Slave with PZE, E-Stop circuit not galvanically isolated	Mounting place
Name	RDS	Name	RDS	EN 62061:2005	SIL 3			+ PNOZX10.11P_3
		Dep.	CS					Page: 3 / 3

Emergency stop applications

PL d of EN ISO 13849-1, SIL 2 of EN 62061

PNOZ XV1P – Safe standstill of a drive

Features

- ▶ Dual-channel operation with detection of shorts across contacts
- ▶ Monitored reset
- ▶ Safe standstill of a drive after E-STOP
- ▶ Contact expansion through positive-guided contactors
- ▶ Feedback circuit to monitor contact expansion

Description

E-STOP function

When the E-STOP pushbutton (S1) is operated, both the drive and the supply to the drive are shut down after a delay time. When the E-STOP pushbutton (S1) is operated, the input circuit on the safety relay PNOZ XV1P (K1) is interrupted, safety contact 13-14 on K1 opens immediately and triggers a “fast stop” at the drive controller A1.

The delay-on de-energisation safety contact 37-38 switches off contactors K2 and K3 after a delay. In this way, the drive controller A1 is isolated from the energy supply (mains) after a delay. The delay-on de-energisation time is set on the safety relay.

Start/reset

The safety relay PNOZ XV1P (K1) can be started by pressing reset button S2 if:

- ▶ E-STOP pushbutton S1 has not been operated and
- ▶ Contactors K2 and K3 have de-energised.

Feedback circuit

The positive-guided N/C contacts on contactors K2 and K3 are monitored in the safety relay’s feedback circuit S33-S34.

Safety assessment

- ▶ The safety relay PNOZ XV1P (K1) and contactors K2 and K3 must be installed in a single mounting area (control cabinet) in order to exclude a short across the output.
- ▶ Earth faults in the input circuit are detected.
- ▶ A fault on the device does not lead to the loss of the safety function.
- ▶ The safety relay PNOZ XV1P (K1) can be started when the input circuit at K1 is closed first, followed by reset button S2. This avoids an unwanted reset before the input circuit is closed or as a result of the reset button being overridden.
- ▶ The delay time set for the safety relay PNOZ XV1P (K1) must be longer than the maximum braking time on the drive regulator A1.

Pilz products

Number	Description	Order number
1	PNOZ XV1P	777 601
1	PITestop Set1.1	400 410

Emergency stop applications

PL d of EN ISO 13849-1, SIL 2 of EN 62061

PNOZ XV1P – Safe standstill of a drive

Safety-related characteristics in accordance with EN ISO 13849-1

Prerequisites:

- ▶ Common cause failure (CCF): Requirements are considered to be met (must be tested on implementation)
- ▶ Mission time: 20 years
- ▶ Operating interval (electromechanical components):
 - Sensor: One operation per week
 - Actuator: One operation per week
- ▶ Characteristic data of contactors K2, K3: B10d: 2,000,000

EN ISO 13849-1		Performance Level	Safety-related parts of the control system
Safety function 1:	Machine shut down via E-STOP	PL d	Sensor (PITestop S1) Logic (PNOZ XV1P K1) Actuator (contactors K2, K3)

Please note the further requirements of EN ISO 13849-1, e.g. requirements for avoiding systematic faults.

Safety-related characteristics in accordance with EN 62061

Prerequisites:

- ▶ Common cause failure (CCF): $\beta = 2 \%$ (must be tested on implementation)
- ▶ Proof test interval: 20 years
- ▶ Operating interval (electromechanical components):
 - Sensor: One operation per week
 - Actuator: One operation per week
- ▶ Characteristic data of contactors K2, K3: B10d: 2,000,000
Dangerous failure rate: 65%

EN 62061		Safety Integrity Level	Subsystems
Safety-related control function (SRCF 1):	Machine shut down via E-STOP	SIL 2	Sensor (PITestop S1) Logic (PNOZ XV1P K1) Actuator (contactors K2, K3)

Please note the further requirements of EN 62061, e.g. requirements for systematic safety integrity.

Classification in accordance with EN 954-1

Depending on the application area and its respective regulations, this connection example is suitable for applications up to Category 3 of EN 954-1.

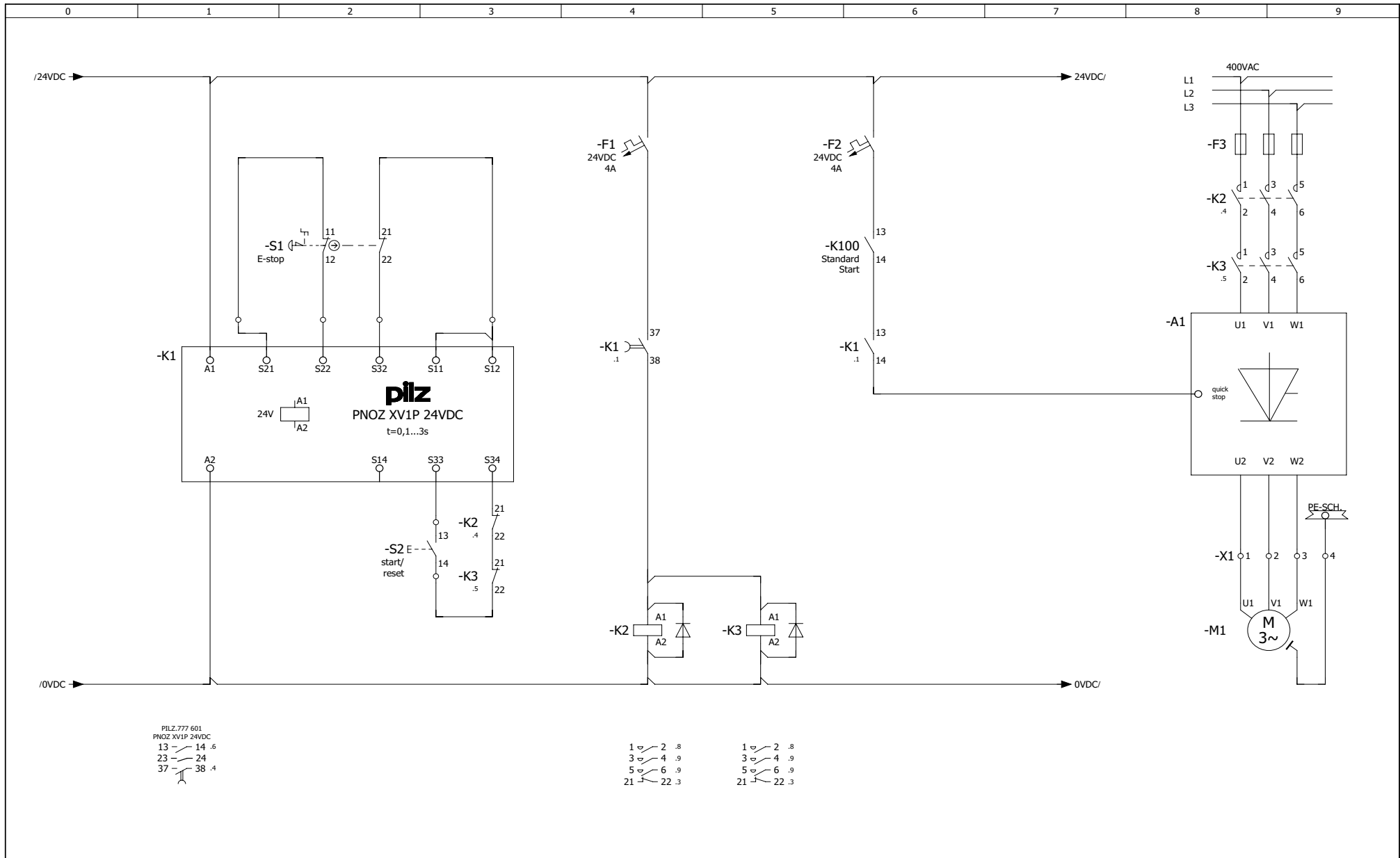

Revision	26.05.2009	Date	19.01.2005	EN ISO 13849-1:2008	PL d	 Pilz GmbH & Co.KG Felix-Wankel-Str.2 73760 Ostfildern	Safe stopping of a drive by Emergency Stop	Mounting place + PNOZXV1P
Name	RDS	Name	WED	EN 62061:2005	SIL 2			Page: 1 / 1
		Dep.	CS					

Contents		Page
Safety gate applications		
PNOZ X2P – PSEN 1.1p safety switch	PL e of EN ISO 13849-1, SIL 3 of EN 62061	2.2-2
PNOZ X2.8P – Connecting three PSEN cs2.1p in series	PL e of EN ISO 13849-1, SIL 3 of EN 62061	2.2-5
PNOZ X3.10P – PSEN me2/2AS and PSEN me1S/1AS with guard locking	PL e of EN ISO 13849-1, SIL 3 of EN 62061	2.2-9
PNOZ X3.10P – Connecting two PSEN cs2.1p in series	PL e of EN ISO 13849-1, SIL 3 of EN 62061	2.2-13

PL e of EN ISO 13849-1, SIL 3 of EN 62061 PNOZ X2P – PSEN 1.1p safety switch

Features

- ▶ Dual-channel operation with detection of shorts across contacts
- ▶ Monitored reset
- ▶ Contact expansion through positive-guided contactors
- ▶ Feedback circuit to monitor contact expansion

Description

Safety gate function

The opening and closing of a safety gate is signalled to the safety relay PNOZ X2P (K1) via the contacts on the safety switch PSEN 1.1p (S1). The contacts on the safety switch S1 are opened as soon as the safety gate is opened. This interrupts the input circuit and the safety contacts on the PNOZ X2P (K1) open. Contactors K2 and K3 de-energise.

Start/reset

The safety relay PNOZ X2P (K1) can be started by pressing reset button S2 if:

- ▶ The safety gate is closed and
- ▶ The contacts on safety switch S1 are closed and
- ▶ Contactors K2 and K3 have de-energised.

Feedback circuit

The positive-guided N/C contacts on contactors K2 and K3 are monitored in the safety relay's reset/feedback circuit S33-S34.

Safety assessment

- ▶ The safety relay PNOZ X2P (K1) and contactors K2 and K3 must be installed in a single mounting area (control cabinet) in order to exclude a short across the output.
- ▶ Earth faults and shorts between contacts in the input circuit are detected.
- ▶ A fault on the device does not lead to the loss of the safety function.
- ▶ The device can be started when the input circuit is closed first, followed by reset button S2. This avoids an unwanted reset before the input circuit is closed or as a result of the reset button being overridden.
- ▶ Increased protection against manipulation is required for hazardous machinery such as presses. In this case we recommend the use of two PSEN 1.1p safety switches.

Pilz products

Number	Description	Order number
1	PNOZ X2P	777 303
1	PSEN 1.1p-10	504 210

PL e of EN ISO 13849-1, SIL 3 of EN 62061 PNOZ X2P – PSEN 1.1p safety switch

Safety-related characteristics in accordance with EN ISO 13849-1

Prerequisites:

- ▶ Common cause failure (CCF): Requirements are considered to be met (must be tested on implementation)
- ▶ Mission time: 20 years
- ▶ Operating interval (electromechanical components):
 - Sensor: Two operations per hour
 - Actuator: Two operations per hour
- ▶ Characteristic data of contactors K2, K3: B10d: 2,000,000

EN ISO 13849-1		Performance Level	Safety-related parts of the control system
Safety function:	Machine shut down when a safety gate is opened	PL e	Sensor (PSEN S1) Logic (PNOZ X2P K1) Actuator (contactors K2, K3)

Please note the further requirements of EN ISO 13849-1, e.g. requirements for avoiding systematic faults.

Safety-related characteristics in accordance with EN 62061

Prerequisites:

- ▶ Common cause failure (CCF): $\beta = 2 \%$ (must be tested on implementation)
- ▶ Proof test interval: 20 years
- ▶ Operating interval (electromechanical components):
 - Sensor: Two operations per hour
 - Actuator: Two operations per hour
- ▶ Characteristic data of contactors K2, K3: B10d: 2,000,000
Dangerous failure rate: 65%

EN 62061		Safety Integrity Level	Subsystems
Safety-related control function (SRCF):	Machine shut down when a safety gate is opened	SIL 3	Sensor (PSEN S1) Logic (PNOZ X2P K1) Actuator (contactors K2, K3)

Please note the further requirements of EN 62061, e.g. requirements for systematic safety integrity.

Classification in accordance with EN 954-1

Depending on the application area and its respective regulations, this connection example is suitable for applications up to Category 4 of EN 954-1.

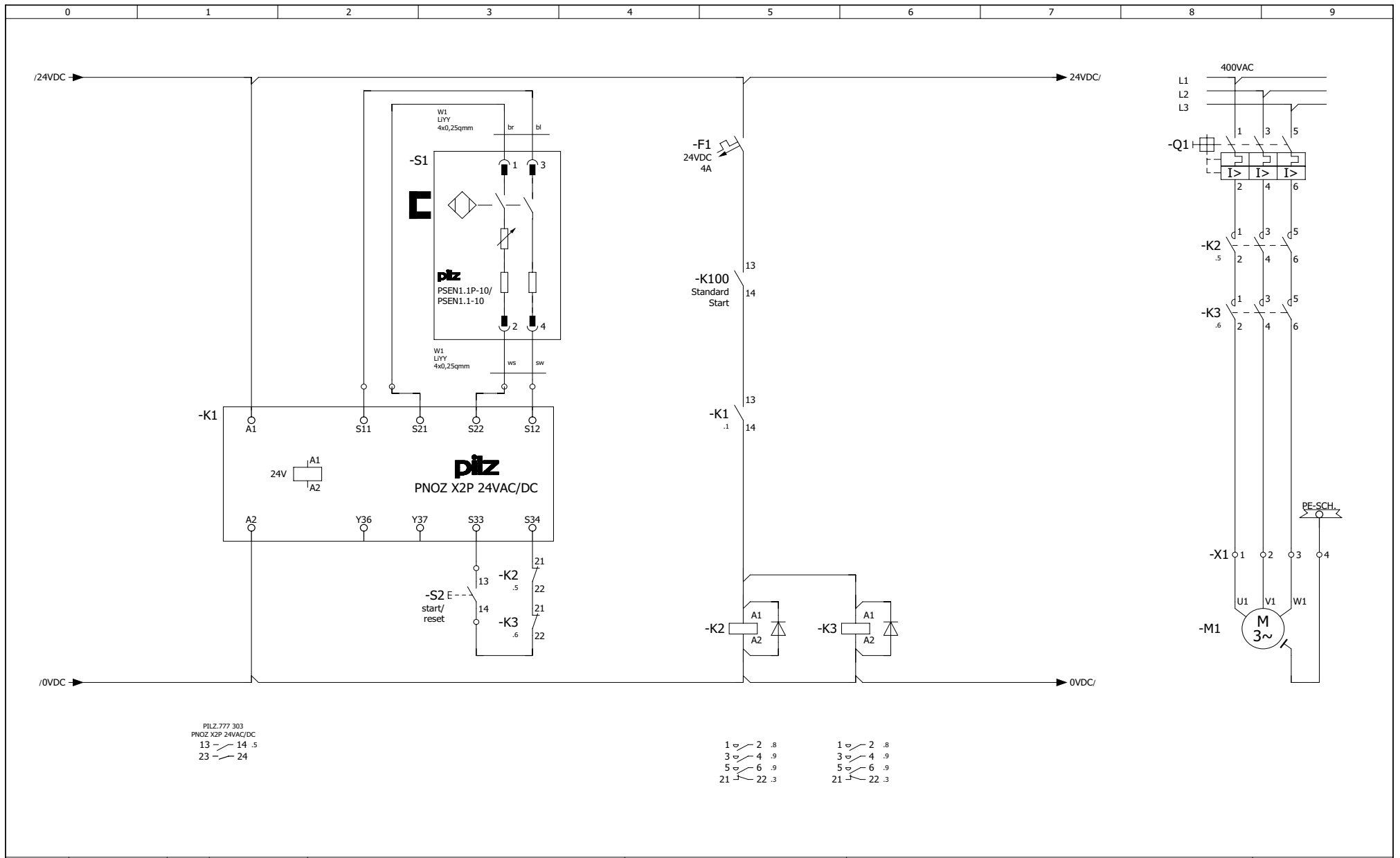

Revision	25.05.2009	Date	19.01.2005	EN ISO 13849-1:2008	PL e	 Pilz GmbH & Co.KG Felix-Wankel-Str.2 73760 Ostfildern	Safety gate with PSEN 1.1p, monitored start with extension contact by contactor	Mounting place + PNOZX2P
Name	RDS	Name	WED	EN 62061:2005	SIL 3			Page: 1 / 1
		Dep.	CS					

PL e of EN ISO 13849-1, SIL 3 of EN 62061 PNOZ X2.8P – Connecting three PSEN cs2.1p in series

Features

- ▶ Dual-channel operation with detection of shorts across contacts
- ▶ Series connection of 3 coded safety switches PSEN cs2.1p
- ▶ Manual reset
- ▶ Contact expansion through positive-guided contactors
- ▶ Feedback circuit to monitor contact expansion

Description

Safety gate function

The opening and closing of several safety gates is signalled to the safety relay PNOZ X2.8P (K8) via the semiconductor outputs on the coded safety switches PSEN cs2.1p (S11 ... S13). The 3 safety switches are connected in series.

The semiconductor outputs on one of the safety switches S11 ... S13 are opened as soon as the respective safety gate is opened. These semiconductor outputs interrupt the input circuit on the safety relay PNOZ X2.8P (K8) and the safety contacts open. Contactors K9 and K10 de-energise. The coded safety switches PSEN cs2.1p (S11 ... S13) have a diagnostic output to display or evaluate the switch status via a PLC.

Start/reset

The safety relay PNOZ X2.8P (K8) can be started by pressing reset button S14 if:

- ▶ The safety gates are closed and
- ▶ The semiconductor outputs on safety switches S11 ... S13 are closed and
- ▶ Contactors K9 and K10 have de-energised.

Feedback circuit

The positive-guided N/C contacts on contactors K9 and K10 are monitored in the safety relay's feedback circuit S12-S34.

Safety assessment

- ▶ The safety relay PNOZ X2.8P (K8) and contactors K9 and K10 must be installed in a single mounting area (control cabinet) in order to exclude a short across the output.
- ▶ Earth faults and shorts between contacts in the input circuit are detected.
- ▶ A fault on the device does not lead to the loss of the safety function.
- ▶ Please note: When several coded safety switches PSEN cs2.1p are connected in series, the delay-on de-energisation time increases in direct proportion to the number of interconnected safety switches.
- ▶ Increased protection against manipulation is required for hazardous machinery such as presses. In this case we recommend the use of two PSEN cs2.1p safety switches (per safety gate).

Pilz products

Number	Description	Order number
1	PNOZ X2.8P	777 301
3	PSEN cs2.1p	540 100

PL e of EN ISO 13849-1, SIL 3 of EN 62061 PNOZ X2.8P – Connecting three PSEN cs2.1p in series

Safety-related characteristics in accordance with EN ISO 13849-1

Prerequisites:

- ▶ Common cause failure (CCF):
Requirements are considered to be met (must be tested on implementation)
- ▶ Mission time: 20 years
- ▶ Operating interval (electromechanical components):
 - Actuator: 6 operations per hour
- ▶ Characteristic data of contactors K9, K10:
B10d: 2,000,000

EN ISO 13849-1	Performance Level	Safety-related parts of the control system
Safety function 1-3: Machine shut down when a safety gate is opened	PL e	Sensor (PSEN S11) Sensor (PSEN S12) Sensor (PSEN S13) Logic (PNOZ X2.8P K8) Actuator (contactors K9, K10)

Please note the further requirements of EN ISO 13849-1, e.g. requirements for avoiding systematic faults.

Safety-related characteristics in accordance with EN 62061

Prerequisites:

- ▶ Common cause failure (CCF): $\beta = 2 \%$ (must be tested on implementation)
- ▶ Proof test interval: 20 years
- ▶ Operating interval (electromechanical components):
 - Actuator: 6 operations per hour
- ▶ Characteristic data of contactors K9, K10:
B10d: 2,000,000
Dangerous failure rate: 65%

EN 62061	Safety Integrity Level	Subsystems
Safety-related control function (SRCF 1-3): Machine shut down when a safety gate is opened	SIL 3	Sensor (PSEN S11) Sensor (PSEN S12) Sensor (PSEN S13) Logic (PNOZ X2.8P K8) Actuator (contactors K9, K10)

Please note the further requirements of EN 62061, e.g. requirements for systematic safety integrity.

Classification in accordance with EN 954-1

Depending on the application area and its respective regulations, this connection example is suitable for applications up to Category 4 of EN 954-1.

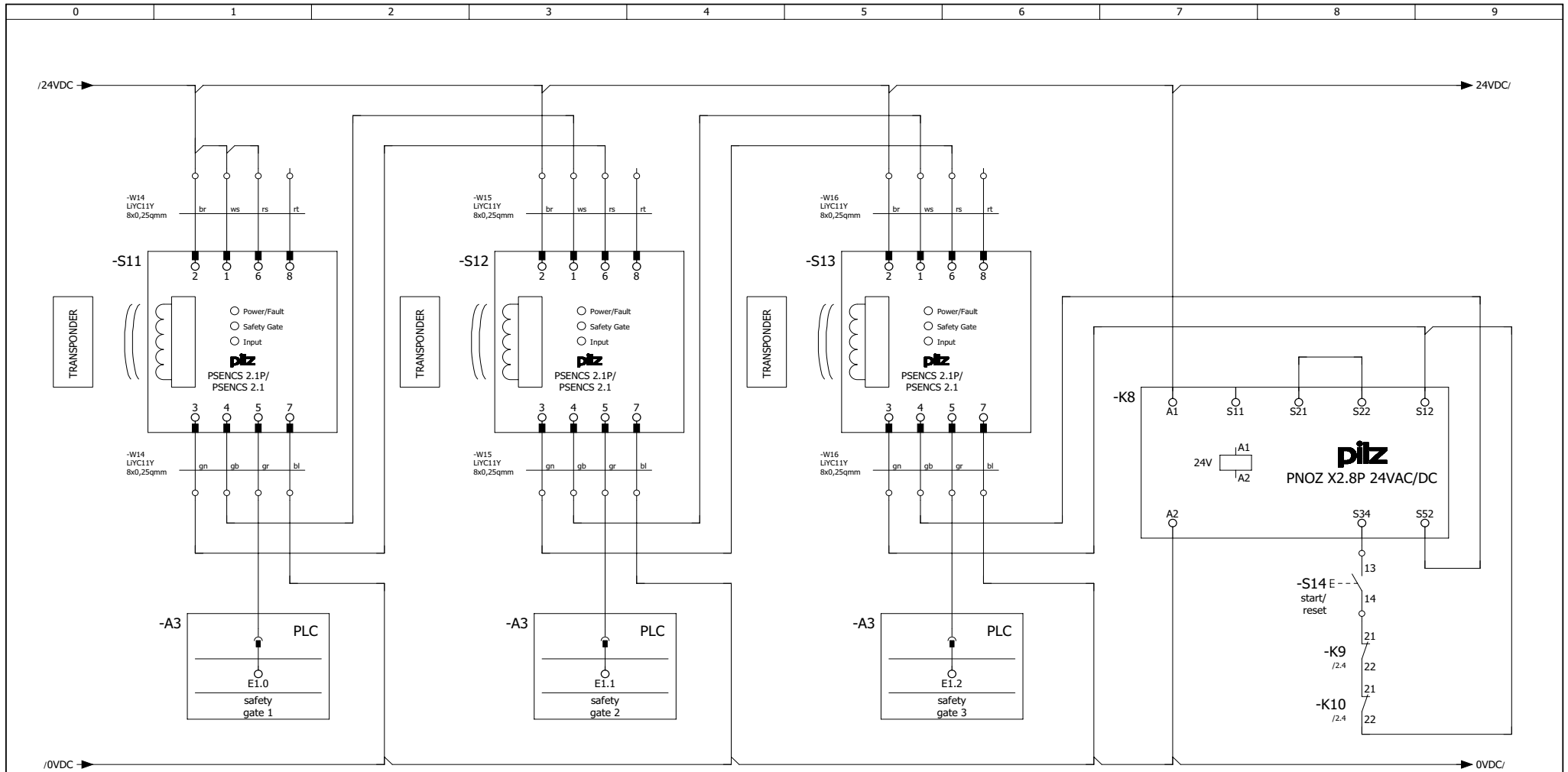

PILZ.777 301
 PNOZ X2.8P 24VAC/DC
 13 — 14 /2.4
 23 — 24
 33 — 34
 41 — 42

Revision	25.05.2009	Date	19.01.2005
Name	RDS	Name	RDS
		Dep.	CS

EN ISO 13849-1:2008	PL e
EN 62061:2005	SIL 3



Series connection safety gate with PSENcs 2.1p and manual start

Mounting place + PNOZX2.8P_3
Page: 1 / 2

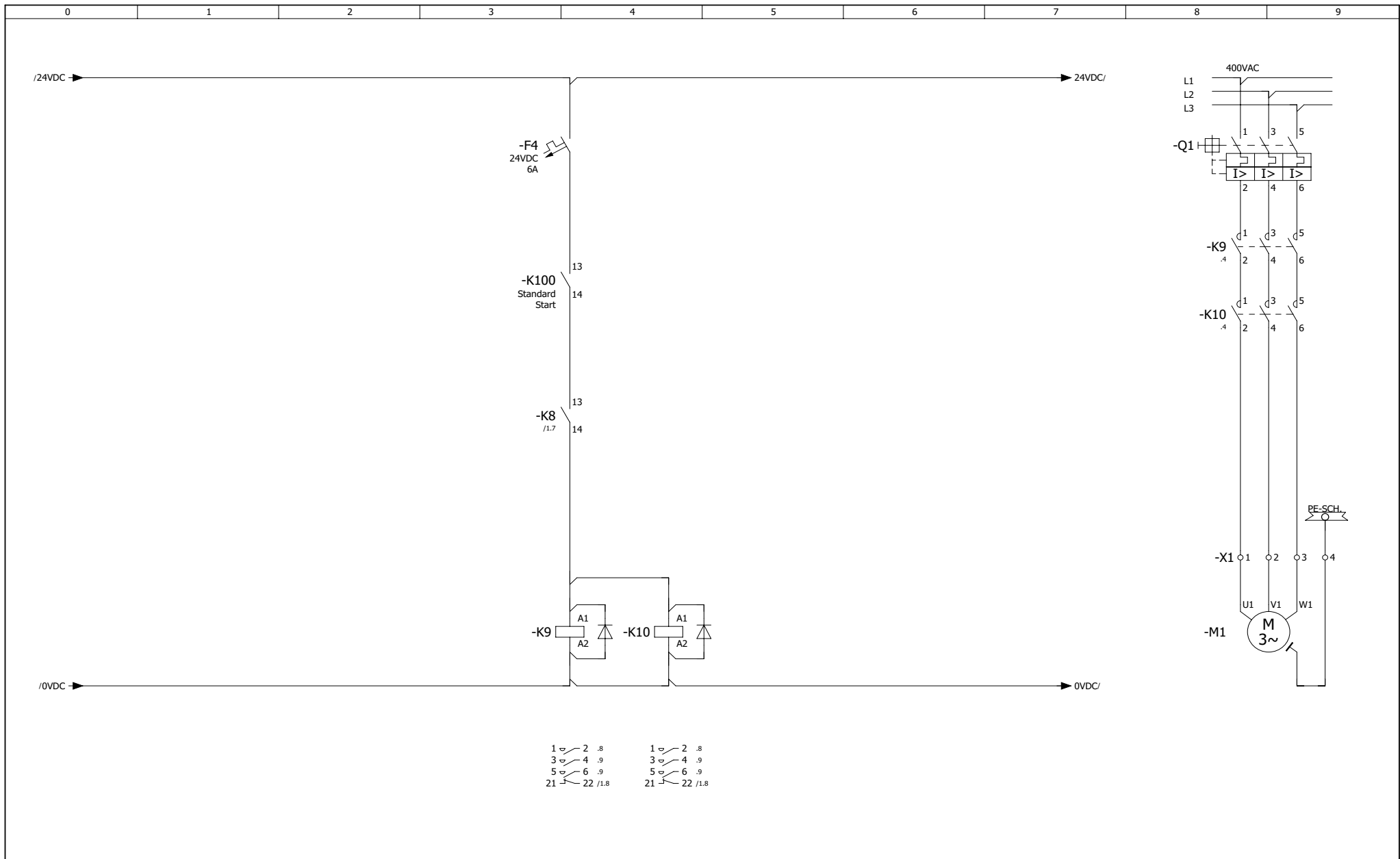

Revision	25.05.2009	Date	19.01.2005	EN ISO 13849-1:2008	PL e	 Pilz GmbH & Co.KG Felix-Wankel-Str.2 73760 Ostfildern	Series connection safety gate with PSENcs 2.1p and manual start	Mounting place + PNOZX2.8P_3
Name	RDS	Name	RDS	EN 62061:2005	SIL 3			Page: 2 / 2
		Dep.	CS					

PL e of EN ISO 13849-1, SIL 3 of EN 62061

PNOZ X3.10P – PSEN me2/2AS and PSEN me1S/1AS with guard locking

Features

- ▶ Dual-channel operation with detection of shorts across contacts
- ▶ Safety gate switches with separate actuator and guard locking device
- ▶ Second safety switch with separate actuator
- ▶ Monitored reset
- ▶ Contact expansion through positive-guided contactors
- ▶ Feedback circuit to monitor contact expansion

Description

Safety gate function

The opening and closing of a safety gate for technical processing purposes is signalled to the PNOZ X3.10P safety relay (K1) via the contacts on the safety switches PSEN me1S/1AS (S1) and PSEN me2/2AS (S2). Guard locking on safety switch (S1) can be released via pushbutton (S4). The technical processing purposes are not safety-related. For example, there is no safe standstill monitoring.

The contacts on safety switches S1 and S2 are opened as soon as the safety gate is opened. This interrupts the input circuit on the safety relay PNOZ X3.10P (K1) and the safety contacts open. Contactors K2 and K3 de-energise. The safety relay PNOZ X3.10P (K1) has a

diagnostic output for display or for evaluation via a PLC.

Start/reset

The safety relay PNOZ X3.10P (K1) can be started by pressing reset button S3 if:

- ▶ The safety gate is closed and
- ▶ The contacts on safety switches S1 and S2 are closed and
- ▶ Contactors K2 and K3 have de-energised.

Feedback circuit

The positive-guided N/C contacts on contactors K2 and K3 are monitored in the safety relay's feedback circuit S33-S34.

Safety assessment

- ▶ The safety relay PNOZ X3.10P (K1) and contactors K2 and K3 must be installed in a single mounting area (control cabinet) in order to exclude a short across the output.
- ▶ Earth faults and shorts between contacts in the input circuit are detected
- ▶ A fault on the device does not lead to the loss of the safety function.
- ▶ The device can be started when the input circuit is closed first, followed by reset button S3. This avoids an unwanted reset before the input circuit is closed or as a result of the reset button being overridden.
- ▶ When the safety switch is released, the safety gate can be opened. Hazardous movements must not overrun or the safety distance must be an appropriate length.

Pilz products

Number	Description	Order number
1	PNOZ X3.10P	777 314
1	PSEN me1S/1AS	570 000
1	PSEN me2/2AS	570 200

PL e of EN ISO 13849-1, SIL 3 of EN 62061

PNOZ X3.10P – PSEN me2/2AS and PSEN me1S/1AS with guard locking

Safety-related characteristics in accordance with EN ISO 13849-1

Prerequisites:

- ▶ Common cause failure (CCF): Requirements are considered to be met (must be tested on implementation)
- ▶ Mission time: 20 years
- ▶ Operating interval (electromechanical components):
 - Sensor: Two operations per hour
 - Actuator: Two operations per hour
- ▶ Characteristic data of contactors K2, K3: B10d: 2,000,000

EN ISO 13849-1		Performance Level	Safety-related parts of the control system
Safety function:	Machine shut down when a safety gate is opened	PL e	Sensor (PSEN me1S/1AS S1) Sensor (PSEN me2/2AS S2) Logic (PNOZ X3.10P K1) Actuator (contactors K2, K3)

Please note the further requirements of EN ISO 13849-1, e.g. requirements for avoiding systematic faults.

Safety-related characteristics in accordance with EN 62061

Prerequisites:

- ▶ Common cause failure (CCF): $\beta = 2 \%$ (must be tested on implementation)
- ▶ Proof test interval: 20 years
- ▶ Operating interval (electromechanical components):
 - Sensor: Two operations per hour
 - Actuator: Two operations per hour
- ▶ Characteristic data of contactors K2, K3: B10d: 2,000,000
Dangerous failure rate: 65%

EN 62061		Safety Integrity Level	Subsystems
Safety-related control function (SRCF):	Machine shut down when a safety gate is opened	SIL 3	Sensor (PSEN me1S/1AS S1) Sensor (PSEN me2/2AS S2) Logic (PNOZ X3.10P K1) Actuator (contactors K2, K3)

Please note the further requirements of EN 62061, e.g. requirements for systematic safety integrity.

Classification in accordance with EN 954-1

Depending on the application area and its respective regulations, this connection example is suitable for applications up to Category 4 of EN 954-1.

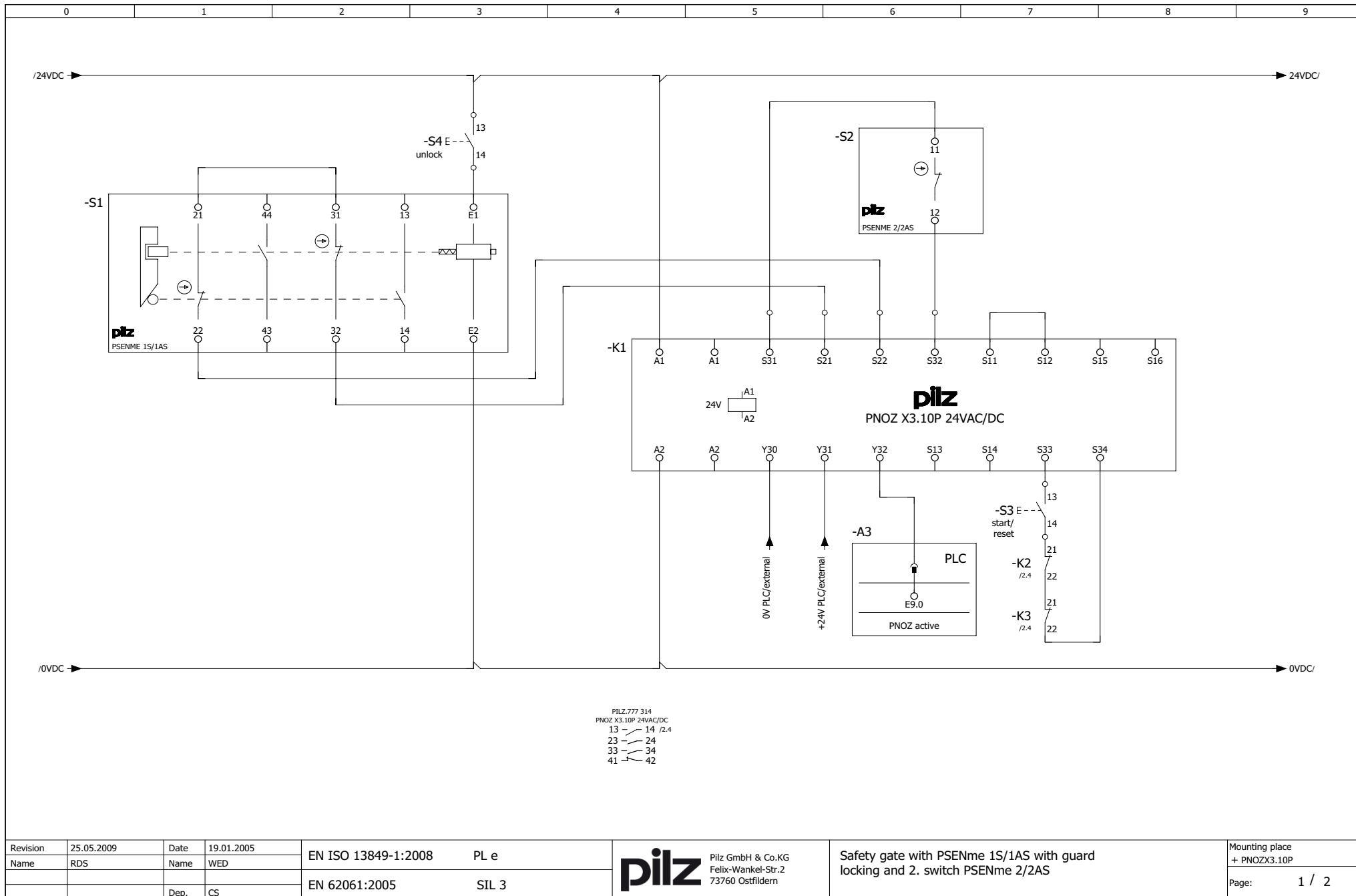

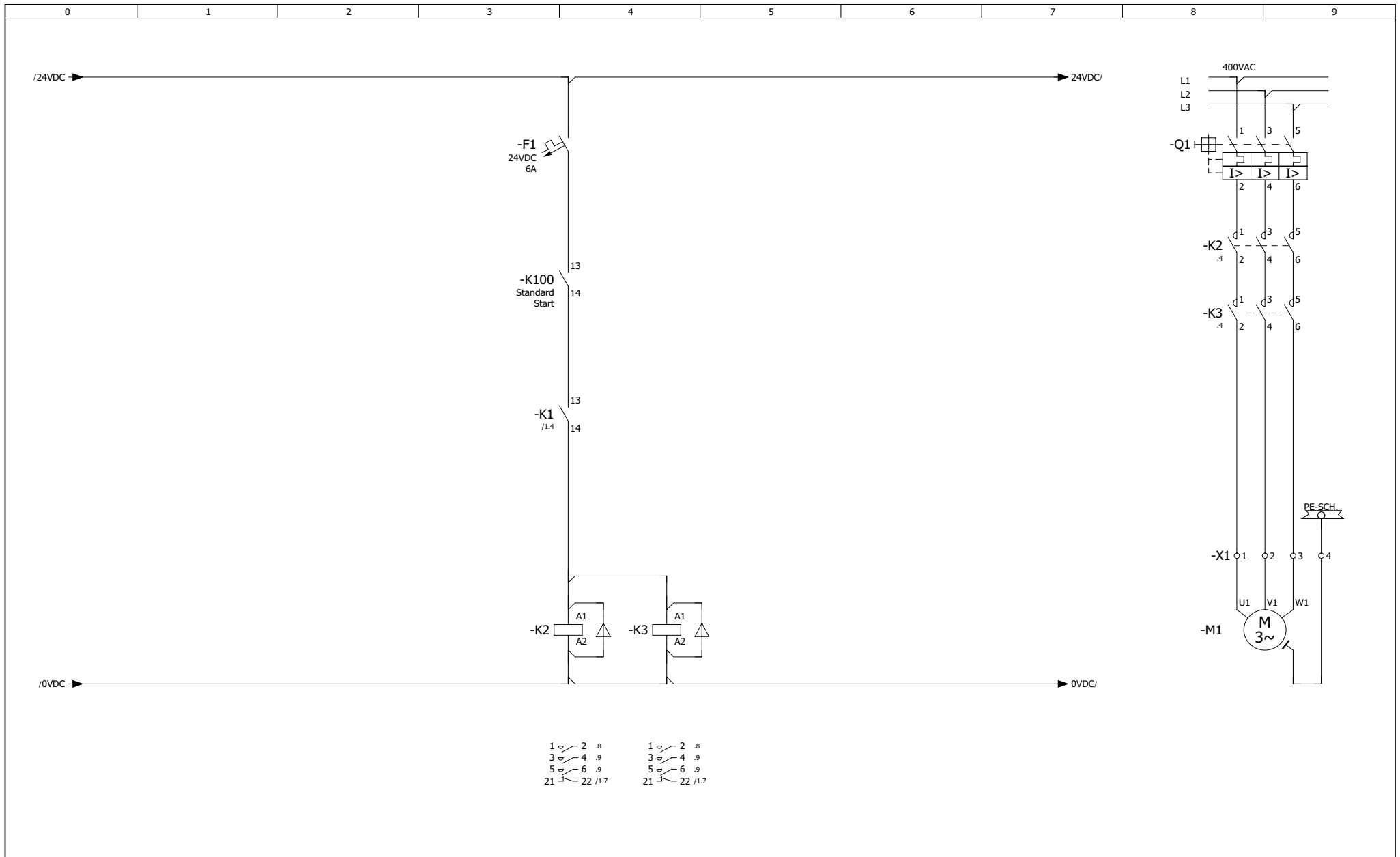

Revision	25.05.2009	Date	19.01.2005
Name	RDS	Name	RDS
		Dep.	CS

EN ISO 13849-1:2008	PL e
EN 62061:2005	SIL 3

pilz Pilz GmbH & Co.KG
Felix-Wankel-Str.2
73760 Ostfildern

Safety gate with PSENme 1S/1AS with guard locking and 2. switch PSENme 2/2AS

Mounting place + PNOZX3.10P
Page: 2 / 2

PL e of EN ISO 13849-1, SIL 3 of EN 62061 PNOZ X3.10P – Connecting two PSEN cs2.1p in series

Features

- ▶ Dual-channel operation with detection of shorts across contacts
- ▶ Series connection of 2 coded PSEN cs2.1p safety switches
- ▶ Monitored reset
- ▶ Contact expansion through positive-guided contactors
- ▶ Feedback circuit to monitor contact expansion

Description

Safety gate function

The opening and closing of several safety gates is signalled to the safety relay PNOZ X3.10P (K7) via the semiconductor outputs on the coded safety switches PSEN cs2.1p (S8, S9). The 2 safety switches are connected in series.

The semiconductor outputs on one of the safety switches S8 or S9 are opened as soon as the respective safety gate is opened. These semiconductor outputs interrupt the input circuit on the safety relay PNOZ X3.10P (K7) and the safety contacts open. Contactors K8 and K9 de-energise. The coded safety switches PSEN cs2.1p (S8, S9) and the safety relay PNOZ X3.10P (K7) each have a diagnostic output to display or evaluate the switch status via a PLC.

Start/reset

The safety relay PNOZ X3.10P (K7) can be started by pressing reset button S7 if:

- ▶ The safety gates are closed and
- ▶ The semiconductor outputs on safety switches S8 and S9 are closed and
- ▶ Contactors K8 and K9 have de-energised.

Feedback circuit

The positive-guided N/C contacts on contactors K8 and K9 are monitored in the safety relay's feedback circuit S33/S34.

Safety assessment

- ▶ The safety relay PNOZ X3.10P (K7) and contactors K8 and K9 must be installed in a single mounting area (control cabinet) in order to exclude a short across the output.
- ▶ Earth faults and shorts between contacts in the input circuit are detected.
- ▶ A fault on the device does not lead to the loss of the safety function.
- ▶ Please note: When several coded safety switches PSEN cs2.1p are connected in series, the delay-on de-energisation time increases in direct proportion to the number of interconnected safety switches.
- ▶ Increased protection against manipulation is required for hazardous machinery such as presses. In this case we recommend the use of two PSEN cs2.1p safety switches (per safety gate).

- ▶ The device can be started when the input circuit is closed first, followed by reset button S7. This avoids an unwanted reset before the input circuit is closed or as a result of the reset button being overridden.

Pilz products

Number	Description	Order number
1	PNOZ X3.10P	777 314
2	PSEN cs2.1p	540 100

PL e of EN ISO 13849-1, SIL 3 of EN 62061 PNOZ X3.10P – Connecting two PSEN cs2.1p in series

Safety-related characteristics in accordance with EN ISO 13849-1

Prerequisites:

- ▶ Common cause failure (CCF): Requirements are considered to be met (must be tested on implementation)
- ▶ Mission time: 20 years
- ▶ Operating interval (electromechanical components):
 - Actuator: Four operations per hour
- ▶ Characteristic data of contactors K8, K9: B10d: 2,000,000

EN ISO 13849-1		Performance Level	Safety-related parts of the control system
Safety function 1-2:	Machine shut down when a safety gate is opened	PL e	Sensor (PSEN S8) Sensor (PSEN S9) Logic (PNOZ X3.10P K7) Actuator (contactors K8, K9)

Please note the further requirements of EN ISO 13849-1, e.g. requirements for avoiding systematic faults.

Safety-related characteristics in accordance with EN 62061

Prerequisites:

- ▶ Common cause failure (CCF): $\beta = 2 \%$ (must be tested on implementation)
- ▶ Proof test interval: 20 years
- ▶ Operating interval (electromechanical components):
 - Actuator: Four operations per hour
- ▶ Characteristic data of contactors K8, K9: B10d: 2,000,000
Dangerous failure rate: 65%

EN 62061		Safety Integrity Level	Subsystems
Safety-related control function (SRCF 1-2):	Machine shut down when a safety gate is opened	SIL 3	Sensor (PSEN S8) Sensor (PSEN S9) Logic (PNOZ X3.10P K7) Actuator (contactors K8, K9)

Please note the further requirements of EN 62061, e.g. requirements for systematic safety integrity.

Classification in accordance with EN 954-1

Depending on the application area and its respective regulations, this connection example is suitable for applications up to Category 4 of EN 954-1.

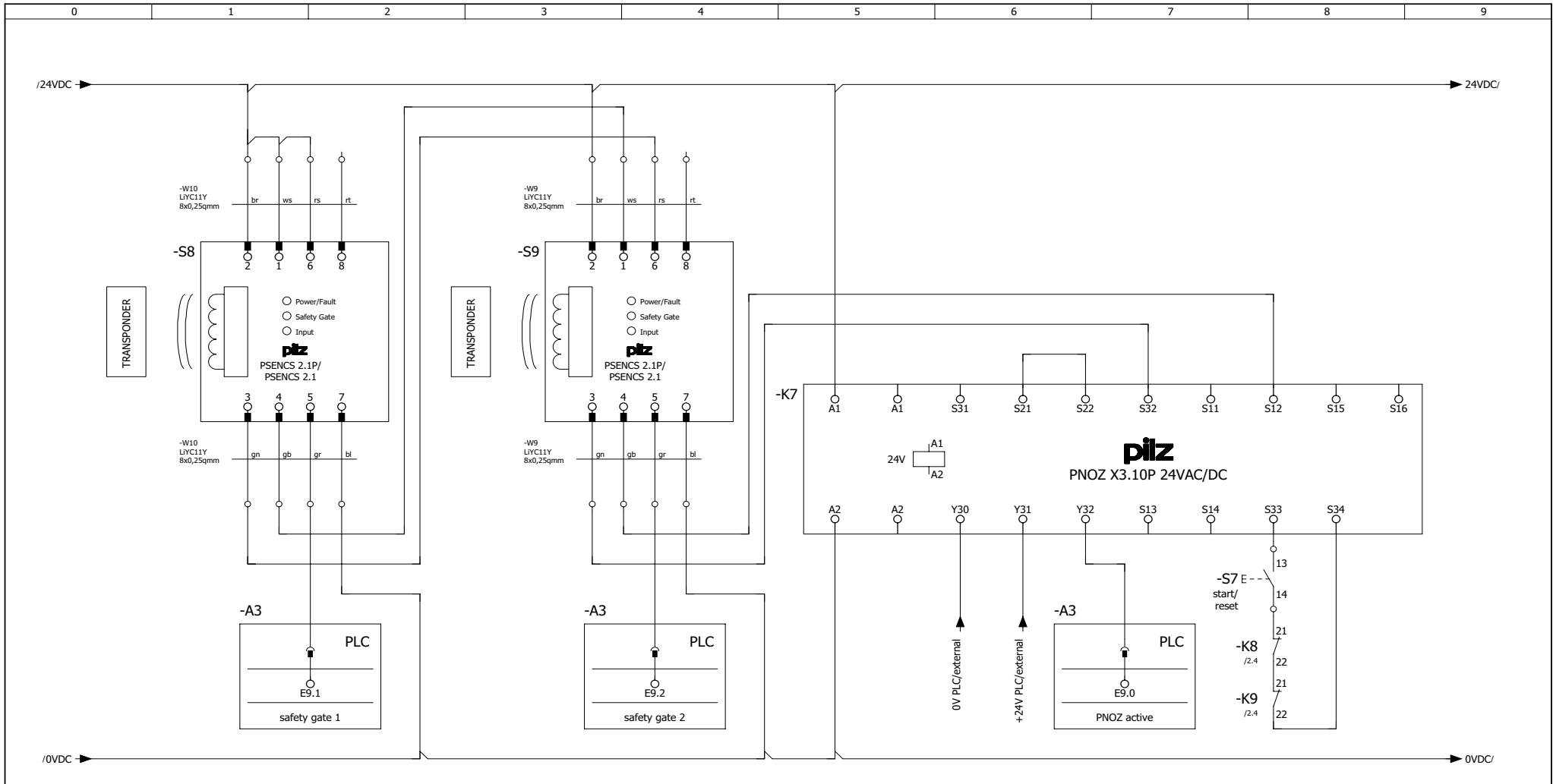

PILZ 777 314
PNOZ X3.10P 24VAC/DC
13 — 14 /2.4
23 — 24
33 — 34
41 — 42

Revision	25.05.2009	Date	19.01.2005	EN ISO 13849-1:2008	PL e	Pilz GmbH & Co.KG Felix-Wankel-Str.2 73760 Ostfildern	Series connection of two PSENcs 2.1p, monitored start	Mounting place + PNOZX3.10P_3
Name	RDS	Name	RDS	EN 62061:2005	SIL 3		Page:	1 / 2
		Dep.	CS					

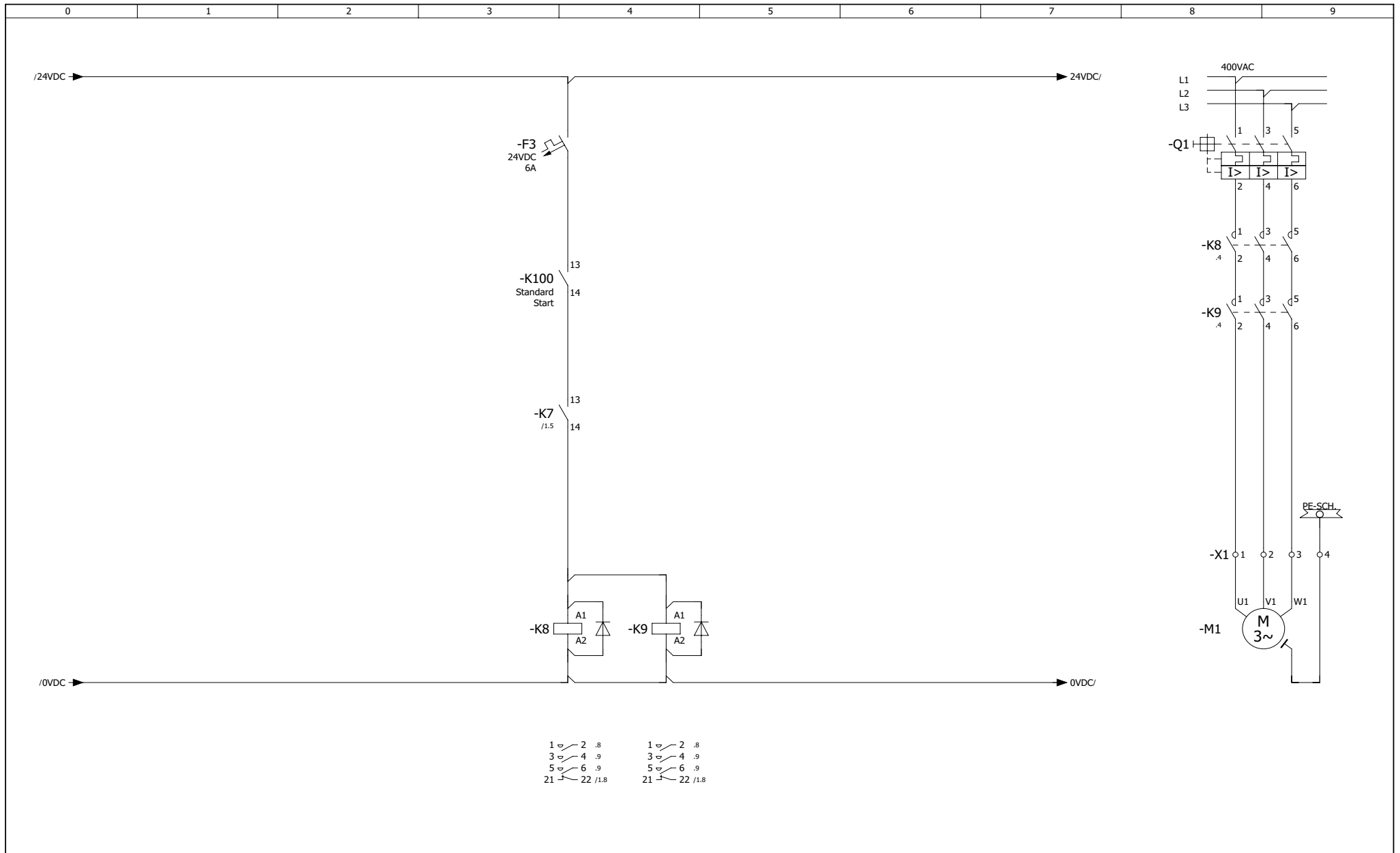

Revision	25.05.2009	Date	19.01.2005	EN ISO 13849-1:2008	PL e	 Pilz GmbH & Co.KG Felix-Wankel-Str.2 73760 Ostfildern	Series connection of two PSEncs 2.1p, monitored start	Mounting place + PNOZX3.10P_3
Name	RDS	Name	RDS	EN 62061:2005	SIL 3			Page: 2 / 2
		Dep.	CS					

Contents		Page
ESPE applications		
PNOZ X2.9P – PSEN op4F-s light curtain	PL e of EN ISO 13849-1, SIL 3 of EN 62061	2.3-2
PNOZ X3P – PSEN op4F-s light curtain	PL e of EN ISO 13849-1, SIL 3 of EN 62061	2.3-6
PNOZ X3.10P – PSEN op4F-s light curtain	PL e of EN ISO 13849-1, SIL 3 of EN 62061	2.3-10
PNOZ X8P – PSEN op4F-S light curtain	PL e of EN ISO 13849-1, SIL 3 of EN 62061	2.3-14
PNOZ X10.11P – PSEN op4F-s light curtain	PL e of EN ISO 13849-1, SIL 3 of en 62061	2.3-18

PL e of EN ISO 13849-1, SIL 3 of EN 62061

PNOZ X2.9P – PSEN op4F-s light curtain

Features

- ▶ Dual-channel operation with detection of shorts across contacts via light curtain
- ▶ Monitored reset
- ▶ Light curtain with semiconductor output
- ▶ Contact expansion through PZE X4P
- ▶ Feedback circuit to monitor contact expansion

Description

Light curtain function

The interruption of light curtain PSEN op4F-s (B1/B2) is signalled to the safety relay PNOZ X2.9P (K1) via the two semiconductor outputs on receiver B2.

The semiconductor outputs on the safety light curtain's receiver B2 are opened as soon as the light curtain is interrupted. This interrupts the input circuit on the safety relay PNOZ X2.9P (K1) and the safety contacts open. The contact expander module PZE X4P (K2) and contactors K3 and K4 de-energise.

The top and bottom DIP switches on the receiver B2 must be set at the same position. For the light curtain to reset automatically, number 4 on both DIP switches must be switched to ON.

Start/reset

The safety relay PNOZ X2.9P (K1) can be started by pressing reset button S2 if:

- ▶ The light curtain is not interrupted and
- ▶ The semiconductor outputs on safety light curtain B1/B2 are closed and
- ▶ The relays on the contact expander module PZE X4P (K2) have de-energised and
- ▶ Contactors K3 and K4 have de-energised.

Feedback circuit

The positive-guided N/C contacts on contactors K3 and K4 are monitored in the safety relay's feedback circuit S12-S34. The feedback circuit on safety relay K1 is linked to the feedback circuit on the contact expander module K2.

Safety assessment

- ▶ The contact expander module PZE X4P (K2) and contactors K3, K4 must be installed in a single mounting area (control cabinet) in order to exclude a short across the output.
- ▶ Earth faults and shorts between contacts in the input circuit are detected via the light curtain.
- ▶ A fault on the device does not lead to the loss of the safety function.
- ▶ A single fault in the light curtain is detected.

- ▶ The device can be started when the input circuit is closed first, followed by reset button S2. This avoids an unwanted reset before the input circuit is closed or as a result of the reset button being overridden.

Pilz products

Number	Description	Order number
1	PNOZ X2.9P	777 300
1	PZE X4P	777 585
1	PSEN op4F-s-14-090	630 605

PL e of EN ISO 13849-1, SIL 3 of EN 62061

PNOZ X2.9P – PSEN op4F-s light curtain

Safety-related characteristics in accordance with EN ISO 13849-1

Prerequisites:

- ▶ Common cause failure (CCF): Requirements are considered to be met (must be tested on implementation)
- ▶ Mission time: 20 years
- ▶ Operating interval (electromechanical components):
 - Actuator: Two operations per hour
- ▶ Characteristic data of contactors K3, K4: B10d: 2,000,000

EN ISO 13849-1		Performance Level	Safety-related parts of the control system
Safety function:	Machine shut down when the safety light curtain is interrupted	PL e	Sensor (PSEN op4F-s B1/B2) Logic (PNOZ X2.9P K1) Logic (PZE X4P K2) Actuator (contactors K3, K4)

Please note the further requirements of EN ISO 13849-1, e.g. requirements for avoiding systematic faults.

Safety-related characteristics in accordance with EN 62061

Prerequisites:

- ▶ Common cause failure (CCF): $\beta = 2 \%$ (must be tested on implementation)
- ▶ Proof test interval: 20 years
- ▶ Operating interval (electromechanical components):
 - Actuator: Two operations per hour
- ▶ Characteristic data of contactors K3, K4: B10d: 2,000,000
Dangerous failure rate: 65%

EN 62061		Safety Integrity Level	Subsystems
Safety-related control function (SRCF):	Machine shut down when the safety light curtain is interrupted	SIL 3	Sensor (PSEN op4F-s B1/B2) Logic (PNOZ X2.9P K1) Logic (PZE X4P K2) Actuator (contactors K3, K4)

Please note the further requirements of EN 62061, e.g. requirements for systematic safety integrity.

Classification in accordance with EN 954-1

Depending on the application area and its respective regulations, this connection example is suitable for applications up to Category 4 of EN 954-1.

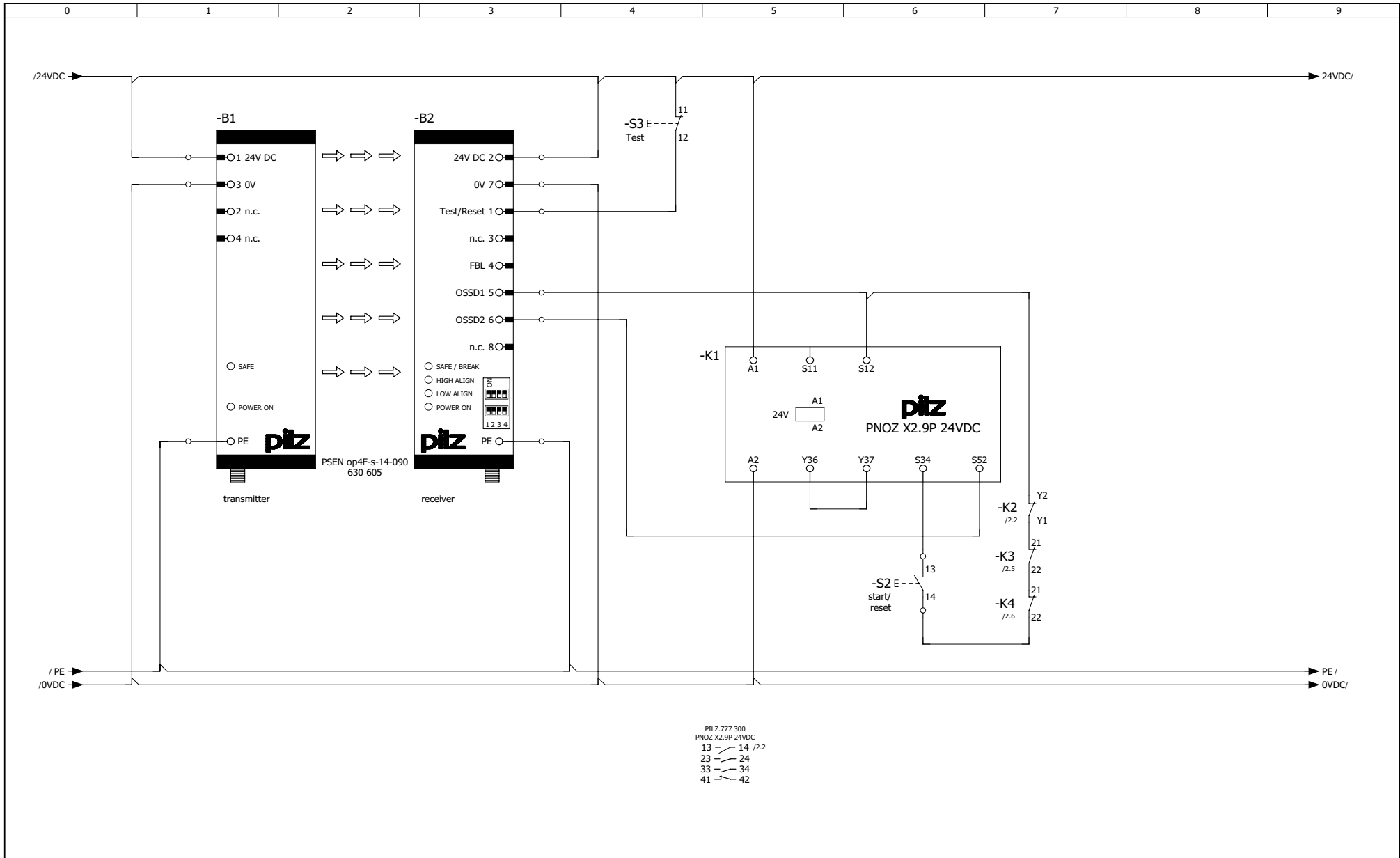

PILZ 777 300
PNOZ X2.9P 24VDC
13 — 14 /2.2
23 — 24
33 — 34
41 — 42

Revision	25.05.2009	Date	19.01.2005	EN ISO 13849-1:2008	PL e	 Pilz GmbH & Co.KG Felix-Wankel-Str.2 73760 Ostfildern	Analysis of one PSEN op4 with monitored start and expander module with PZE X4P	Mounting place + PNOZX2.9P
Name	RDS	Name	WED	EN 62061:2005	SIL 3			Page:
		Dep.	CS					

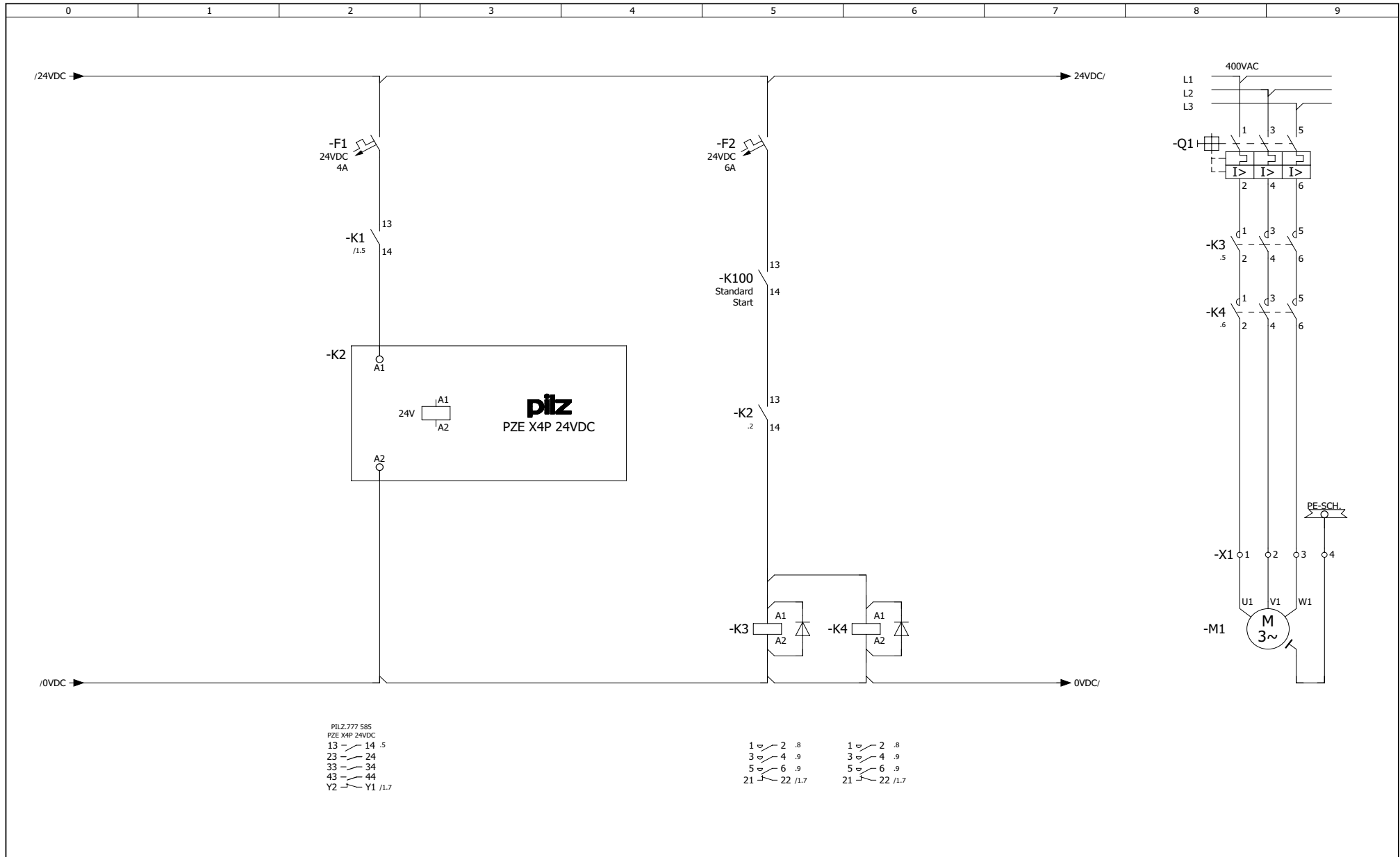

Revision	25.05.2009	Date	19.01.2005	EN ISO 13849-1:2008	PL e	 Pilz GmbH & Co.KG Felix-Wankel-Str.2 73760 Ostfildern	Analysis of one PSEN op4 with monitored start and expander module with PZE X4P	Mounting place + PNOZX2.9P
Name	RDS	Name	RDS	EN 62061:2005	SIL 3			Page: 2 / 2
		Dep.	CS					

Level of EN ISO 13849-1, SIL 3 of EN 62061 PNOZ X3P – PSEN op4F-s light curtain

Features

- ▶ Dual-channel operation with detection of shorts across contacts via light curtain
- ▶ Monitored reset
- ▶ Light curtain with semiconductor output
- ▶ Contact expansion through PZE X5P and positive-guided contactors
- ▶ Feedback circuit to monitor contact expansion

Description

Light curtain function

The interruption of light curtain PSEN op4F-s (B1/B2) is signalled to the safety relay PNOZ X3P (K1) via the two semiconductor outputs on receiver B2.

The semiconductor outputs on the safety light curtain's receiver B2 are opened as soon as the light curtain is interrupted. This interrupts the input circuit on the safety relay PNOZ X3P (K1) and the safety contacts open. The input circuit on the contact expander module PZE X5P (K2) is interrupted and the safety contacts open. Contactors K3 and K4 de-energise. The top and bottom DIP switches on the receiver B2 must be set at the same position. For the light curtain to reset automatically, number 4 on both DIP switches must be switched to ON. The safety relay PNOZ X3P (K1) and contact expander module PZE X5P (K2) have diagnostic outputs for display or for

evaluation via a PLC.

Start/reset

- The safety relay PNOZ X3P (K1) can be started by pressing reset button S1 if:
- ▶ The light curtain is not interrupted and
 - ▶ The semiconductor outputs on safety light curtain B1/B2 are closed and
 - ▶ The relays on the contact expander module PZE X5P (K2) have de-energised and
 - ▶ Contactors K3 and K4 have de-energised.

Feedback circuit

The positive-guided N/C contacts on contactors K3 and K4 are monitored in the safety relay's feedback circuit S33-S34. The feedback circuit on safety relay K1 is linked to the feedback circuit on the contact expander module K2.

Safety assessment

- ▶ The contact expander module PZE X5P (K2) and contactors K3 and K4 must be installed in a single mounting area (control cabinet) in order to exclude a short across the output.
- ▶ Earth faults and shorts between contacts in the input circuit are detected via the light curtain.
- ▶ A fault on the device does not lead to the loss of the safety function.
- ▶ A single fault in the light curtain is detected.
- ▶ The device can be started when the input circuit is closed first, followed by reset

button S1. This avoids an unwanted reset before the input circuit is closed or as a result of the reset button being overridden.

Pilz products

Number	Description	Order number
1	PNOZ X3P	777 310
1	PZE X5P	777 150
1	PSEN op4F-s-14-090	630 605

PL e of EN ISO 13849-1, SIL 3 of EN 62061

PNOZ X3P – PSEN op4F-s light curtain

Safety-related characteristics in accordance with EN ISO 13849-1

Prerequisites:

- ▶ Common cause failure (CCF): Requirements are considered to be met (must be tested on implementation)
- ▶ Mission time: 20 years
- ▶ Operating interval (electromechanical components):
 - Actuator: Two operations per hour
- ▶ Characteristic data of contactors K3, K4: B10d: 2,000,000

EN ISO 13849-1		Performance Level	Safety-related parts of the control system
Safety function:	Machine shut down when the safety light curtain is interrupted	PL e	Sensor (PSEN op4F-s B1/B2) Logic (PNOZ X3P K1) Logic (PZE X5P K2) Actuator (contactors K3, K4)

Please note the further requirements of EN ISO 13849-1, e.g. requirements for avoiding systematic faults.

Safety-related characteristics in accordance with EN 62061

Prerequisites:

- ▶ Common cause failure (CCF): $\beta = 2 \%$ (must be tested on implementation)
- ▶ Proof test interval: 20 years
- ▶ Operating interval (electromechanical components):
 - Actuator: Two operations per hour
- ▶ Characteristic data of contactors K3, K4: B10d: 2,000,000
Dangerous failure rate: 65%

EN 62061		Safety Integrity Level	Subsystems
Safety-related control function (SRCF):	Machine shut down when the safety light curtain is interrupted	SIL 3	Sensor (PSEN op4F-s B1/B2) Logic (PNOZ X3P K1) Logic (PZE X5P K2) Actuator (contactors K3, K4)

Please note the further requirements of EN 62061, e.g. requirements for systematic safety integrity.

Classification in accordance with EN 954-1

Depending on the application area and its respective regulations, this connection example is suitable for applications up to Category 4 of EN 954-1.

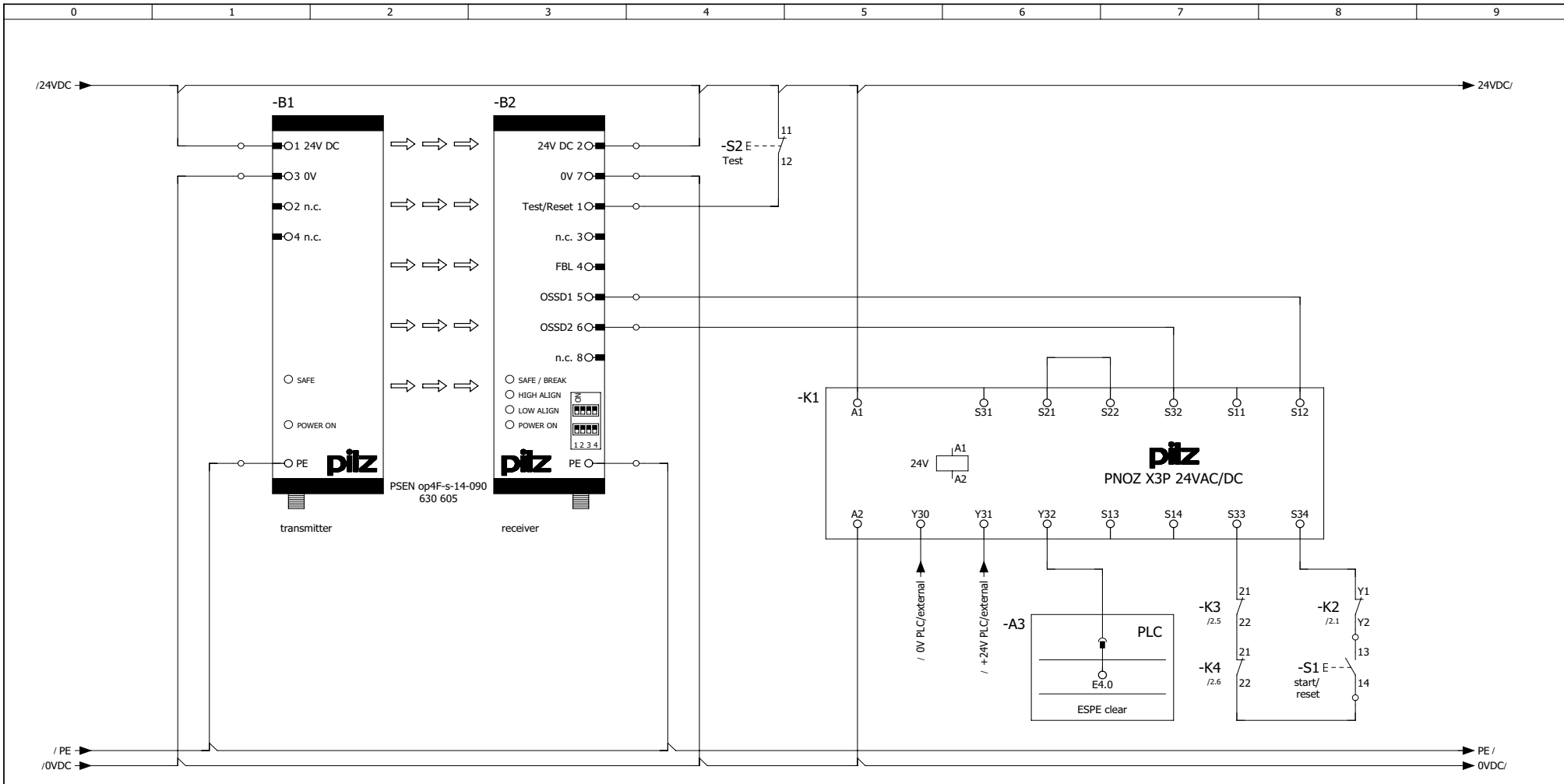

PILZ 777 310
PNOZ X3P 24VAC/DC
13 — 14 /2.3
23 — 24 /2.3
33 — 34
41 — 42

Revision	25.05.2009	Date	19.01.2005
Name	RDS	Name	WED
		Dep.	CS

EN ISO 13849-1:2008	PL e
EN 62061:2005	SIL 3

pilz Pilz GmbH & Co.KG
Felix-Wankel-Str.2
73760 Ostfildern

Analysis of one PSEN op4 with monitored start and expander module

Mounting place + PNOZX3P
Page: 1 / 2

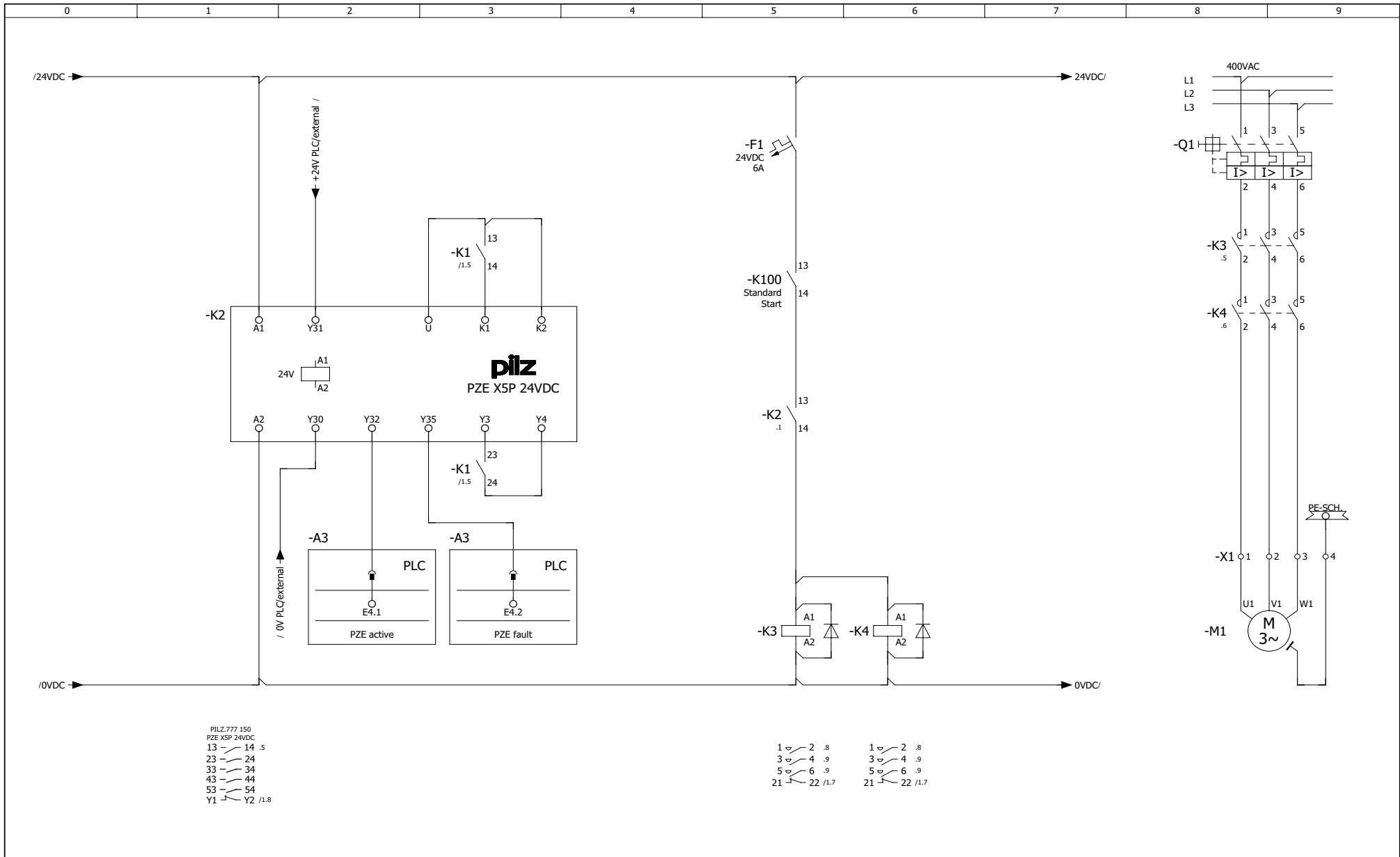

PILZ.777 150
PZE X5P 24VDC
13 - 14 .5
23 - 24
33 - 34
43 - 44
53 - 54
Y1 - Y2 /1.8

1 - 2 .8
3 - 4 .9
5 - 6 .9
21 - 22 /1.7
1 - 2 .8
3 - 4 .9
5 - 6 .9
21 - 22 /1.7

Revision	25.05.2009	Date	19.01.2005	EN ISO 13849-1:2008	PL e	 Pilz GmbH & Co.KG Felix-Wankel-Str.2 73760 Ostfildern	Analysis of one PSEN op4 with monitored start and expander module	Mounting place + PNO2X3P	
Name	RDS	Name	RDS	EN 62061:2005	SIL 3			Page:	2 / 2
		Dep.	CS						

PL e of EN ISO 13849-1, SIL 3 of EN 62061

PNOZ X3.10P – PSEN op4F-s light curtain

Features

- ▶ Dual-channel operation with detection of shorts across contacts via light curtain
- ▶ Monitored reset
- ▶ Light curtain with semiconductor output
- ▶ Contact expansion through positive-guided contactors
- ▶ Feedback circuit to monitor contact expansion

Description

Light curtain function

The interruption of light curtain PSEN op4F-s (B1/B2) is signalled to the safety relay PNOZ X3.10P (K4) via the two semiconductor outputs on receiver B2.

The semiconductor outputs on the safety light curtain's receiver B2 are opened as soon as the light curtain is interrupted. This interrupts the input circuit on the safety relay PNOZ X3.10P (K4) and the safety contacts open. Contactors K5 and K6 de-energise.

The top and bottom DIP switches on the receiver B2 must be set at the same position. For the light curtain to reset automatically, number 4 on both DIP switches must be switched to ON. The safety relay PNOZ X3.10P (K4) has a diagnostic output for display or for evaluation via a PLC.

Start/reset

The safety relay PNOZ X3.10P (K4) can be started by pressing reset button S5 if:

- ▶ The light curtain is not interrupted and
- ▶ The semiconductor outputs on safety light curtain B1/B2 are closed and
- ▶ Contactors K5 and K6 have de-energised.

Feedback circuit

The positive-guided N/C contacts on contactors K5 and K6 are monitored in the safety relay's feedback circuit S33/S34.

Safety assessment

- ▶ The safety relay PNOZ X3.10P (K4) and contactors K5 and K6 must be installed in a single mounting area (control cabinet) in order to exclude a short across the output.
- ▶ Earth faults and shorts between contacts in the input circuit are detected via the light curtain.
- ▶ A fault on the device does not lead to the loss of the safety function.
- ▶ A single fault in the light curtain is detected.
- ▶ The device can be started when the input circuit is closed first, followed by reset button S5. This avoids an unwanted reset before the input circuit is closed or as a result of the reset button being overridden.

Pilz products

Number	Description	Order number
1	PNOZ X3.10P	777 314
1	PSEN op4F-s-14-090	630 605

PL e of EN ISO 13849-1, SIL 3 of EN 62061

PNOZ X3.10P – PSEN op4F-s light curtain

Safety-related characteristics in accordance with EN ISO 13849-1

Prerequisites:

- ▶ Common cause failure (CCF): Requirements are considered to be met (must be tested on implementation)
- ▶ Mission time: 20 years
- ▶ Operating interval (electromechanical components):
 - Actuator: Two operations per hour
- ▶ Characteristic data of contactors K5, K6: B10d: 2,000,000

EN ISO 13849-1		Performance Level	Safety-related parts of the control system
Safety function:	Machine shut down when the safety light curtain is interrupted	PL e	Sensor (PSEN op4F-s B1/B2) Logic (PNOZ X3.10P K4) Actuator (contactors K5, K6)

Please note the further requirements of EN ISO 13849-1, e.g. requirements for avoiding systematic faults.

Safety-related characteristics in accordance with EN 62061

Prerequisites:

- ▶ Common cause failure (CCF): $\beta = 2 \%$ (must be tested on implementation)
- ▶ Proof test interval: 20 years
- ▶ Operating interval (electromechanical components):
 - Actuator: Two operations per hour
- ▶ Characteristic data of contactors K5, K6: B10d: 2,000,000
Dangerous failure rate: 65%

EN 62061		Safety Integrity Level	Subsystems
Safety-related control function (SRCF):	Machine shut down when the safety light curtain is interrupted	SIL 3	Sensor (PSEN op4F-s B1/B2) Logic (PNOZ X3.10P K4) Actuator (contactors K5, K6)

Please note the further requirements of EN 62061, e.g. requirements for systematic safety integrity.

Classification in accordance with EN 954-1

Depending on the application area and its respective regulations, this connection example is suitable for applications up to Category 4 of EN 954-1.

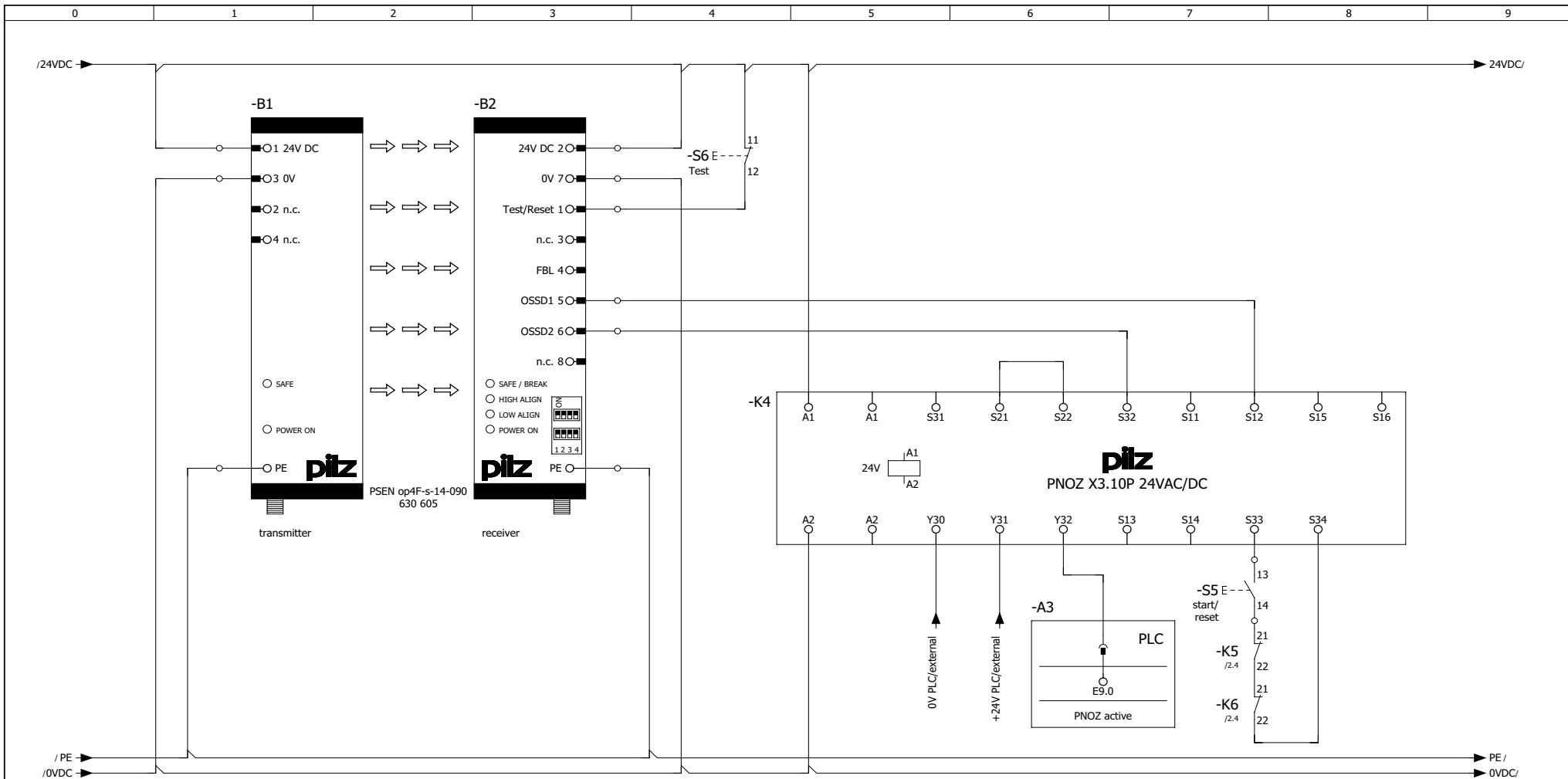

PILZ.777 314
PNOZ X3.10P 24VAC/DC
13 — 14 /2,4
23 — 24
33 — 34
41 — 42

Revision	25.05.2009	Date	19.01.2005
Name	RDS	Name	RDS
		Dep.	CS

EN ISO 13849-1:2008	PL e
EN 62061:2005	SIL 3



ESPE PSEN op4 with monitored start of PNOZ X3.10P	Mounting place + PNOZX3.10P_2
	Page: 1 / 2

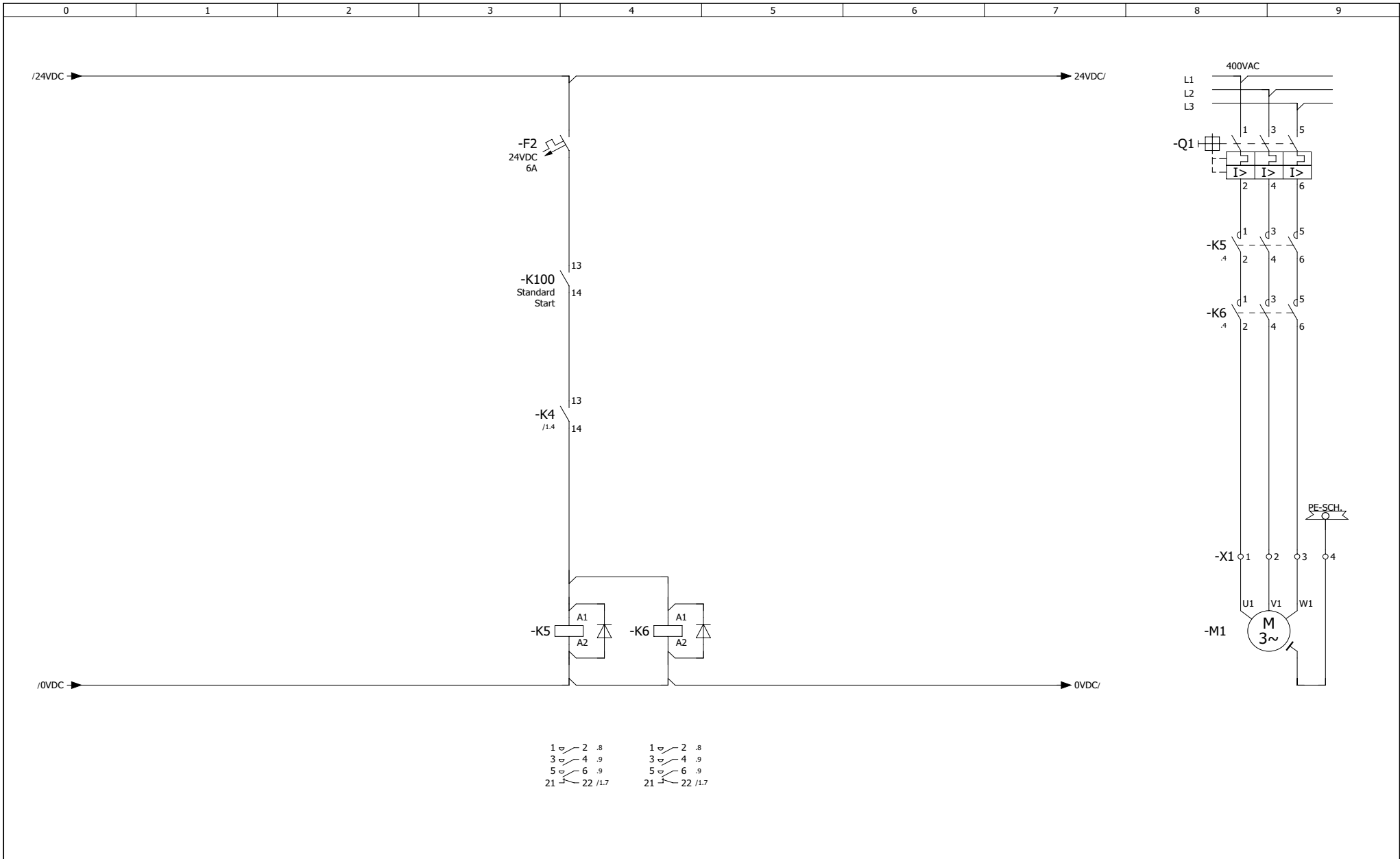

Revision	25.05.2009	Date	19.01.2005	EN ISO 13849-1:2008	PL e	 Pilz GmbH & Co.KG Felix-Wankel-Str.2 73760 Ostfildern	ESPE PSEN op4 with monitored start of PNOZ X3.10P	Mounting place + PNOZX3.10P_2
Name	RDS	Name	RDS					Page: 2 / 2
		Dep.	CS	EN 62061:2005	SIL 3			

PL e of EN ISO 13849-1, SIL 3 of EN 62061

PNOZ X8P – PSEN op4F-s light curtain

Features

- ▶ Dual-channel operation with detection of shorts across contacts via light curtain
- ▶ Monitored reset
- ▶ Light curtain with semiconductor output
- ▶ Contact expansion through positive-guided contactors
- ▶ Feedback circuit to monitor contact expansion

Description

Light curtain function

The interruption of light curtain PSEN op4F-s (B1/B2) is signalled to the PNOZ X8P safety relay (K1) via the two semiconductor outputs on receiver B2.

The semiconductor outputs on the safety light curtain's receiver B2 are opened as soon as the light curtain is interrupted. This interrupts the input circuit on the safety relay PNOZ X8P (K1) and the safety contacts open. Contactors K2 and K3 de-energise.

The top and bottom DIP switches on the receiver B2 must be set at the same position. For the light curtain to reset automatically, number 4 on both DIP switches must be switched to ON. The safety relay PNOZ X8P (K1) has a diagnostic output for display or for evaluation via a PLC.

Start/reset

The safety relay PNOZ X8P (K1) can be started by pressing reset button S1 if:

- ▶ The light curtain is not interrupted and
- ▶ The semiconductor outputs on safety light curtain B1/B2 are closed and
- ▶ Contactors K2 and K3 have de-energised.

Feedback circuit

The positive-guided N/C contacts on contactors K2 and K3 are monitored in the safety relay's feedback circuit Y1-Y2.

Safety assessment

- ▶ The safety relay PNOZ X8P (K1) and contactors K2, K3 must be installed in a single mounting area (control cabinet) in order to exclude a short across the output.
- ▶ Earth faults and shorts between contacts in the input circuit are detected via the light curtain.
- ▶ A fault on the device does not lead to the loss of the safety function.
- ▶ A single fault in the light curtain is detected.
- ▶ The device can be started when the input circuit is closed first, followed by reset button S1. This avoids an unwanted reset before the input circuit is closed or as a result of the reset button being overridden.

Pilz products

Number	Description	Order number
1	PNOZ X8P	777 760
1	PSEN op4F-s-14-090	630 605

PL e of EN ISO 13849-1, SIL 3 of EN 62061 PNOZ X8P – PSEN op4F-s light curtain

Safety-related characteristics in accordance with EN ISO 13849-1

Prerequisites:

- ▶ Common cause failure (CCF): Requirements are considered to be met (must be tested on implementation)
- ▶ Mission time: 20 years
- ▶ Operating interval (electromechanical components):
 - Actuator: Two operations per hour
- ▶ Characteristic data of contactors K2, K3: B10d: 2,000,000

EN ISO 13849-1		Performance Level	Safety-related parts of the control system
Safety function:	Machine shut down when the safety light curtain is interrupted	PL e	Sensor (PSEN op4F-s B1/B2) Logic (PNOZ X8P K1) Actuator (contactors K2, K3)

Please note the further requirements of EN ISO 13849-1, e.g. requirements for avoiding systematic faults.

Safety-related characteristics in accordance with EN 62061

Prerequisites:

- ▶ Common cause failure (CCF): $\beta = 2 \%$ (must be tested on implementation)
- ▶ Proof test interval: 20 years
- ▶ Operating interval (electromechanical components):
 - Actuator: Two operations per hour
- ▶ Characteristic data of contactors K2, K3: B10d: 2,000,000
Dangerous failure rate: 65%

EN 62061		Safety Integrity Level	Subsystems
Safety-related control function (SRCF):	Machine shut down when the safety light curtain is interrupted	SIL 3	Sensor (PSEN op4F-s B1/B2) Logic (PNOZ X8P K1) Actuator (contactors K2, K3)

Please note the further requirements of EN 62061, e.g. requirements for systematic safety integrity.

Classification in accordance with EN 954-1

Depending on the application area and its respective regulations, this connection example is suitable for applications up to Category 4 of EN 954-1.

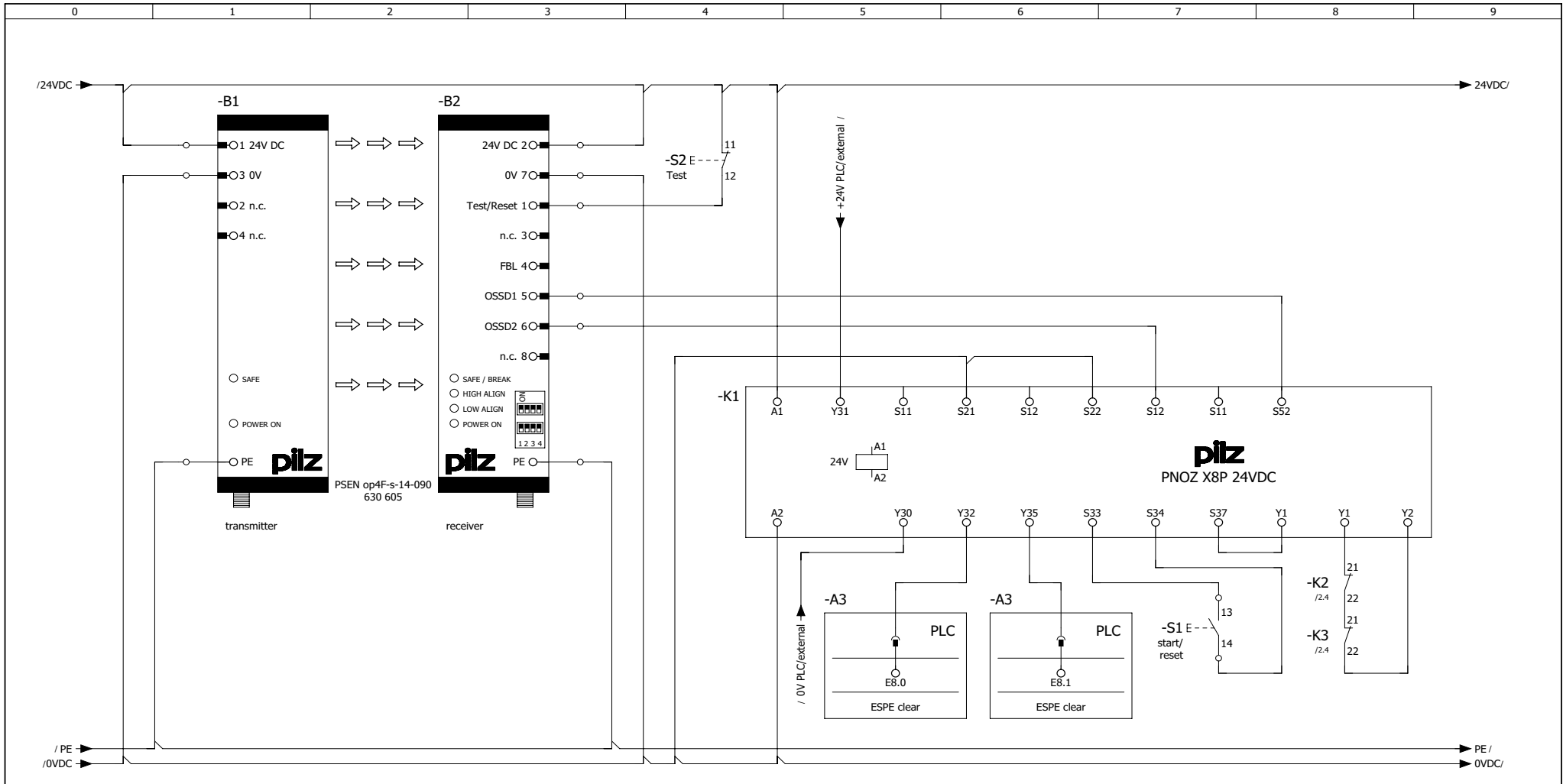

PILZ.777 760
PNOZ X8P 24VDC
13 --- 14 /2,4
23 --- 24
33 --- 34
41 --- 42
51 --- 52

Revision	25.05.2009	Date	19.01.2005	EN ISO 13849-1:2008	PL e	Pilz GmbH & Co.KG Felix-Wankel-Str.2 73760 Ostfildern	ESPE PSEN op4 with monitored start of PNOZ X8P	Mounting place + PNOZX8P
Name	RDS	Name	WED	EN 62061:2005	SIL 3		Page: 1 / 2	
		Dep.	CS					

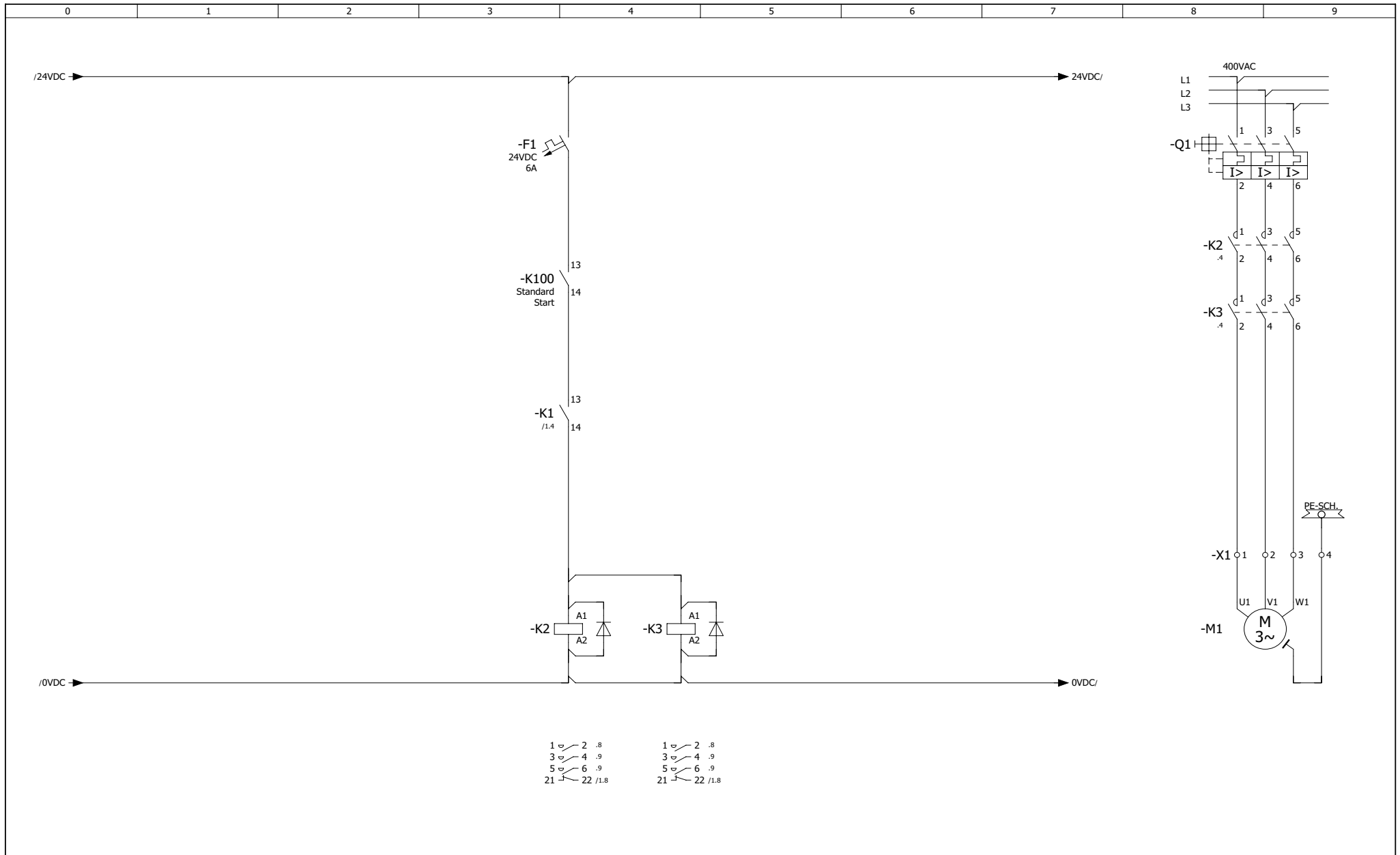

Revision	25.05.2009	Date	19.01.2005	EN ISO 13849-1:2008	PL e	 Pilz GmbH & Co.KG Felix-Wankel-Str.2 73760 Ostfildern	ESPE PSEN op4 with monitored start of PNOZ X8P	Mounting place + PNOZX8P
Name	RDS	Name	RDS	EN 62061:2005	SIL 3			Page: 2 / 2
		Dep.	CS					

PL e of EN ISO 13849-1, SIL 3 of EN 62061 PNOZ X10.11P – PSEN op4F-s light curtain

Features

- ▶ Dual-channel operation with detection of shorts across contacts via light curtain
- ▶ Monitored reset
- ▶ Light curtain with semiconductor output
- ▶ Contact expansion through positive-guided contactors
- ▶ Feedback circuit to monitor contact expansion

Description

Light curtain function

The interruption of light curtain PSEN op4F-s (B1/B2) is signalled to the safety relay PNOZ X10.11P (K11) via the two semiconductor outputs on receiver B2.

The semiconductor outputs on the safety light curtain's receiver B2 are opened as soon as the light curtain is interrupted. This interrupts the input circuit on the safety relay PNOZ X10.11P (K11) and the safety contacts open. Contactors K12 and K13 de-energise.

The top and bottom DIP switches on the receiver B2 must be set at the same position. For the light curtain to reset automatically, number 4 on both DIP switches must be switched to ON.

Start/reset

The safety relay PNOZ X10.11P (K11) can be started by pressing reset button S11 if:

- ▶ The light curtain is not interrupted and
- ▶ The semiconductor outputs on safety light curtain B1/B2 are closed and
- ▶ Contactors K12 and K13 have de-energised.

Feedback circuit

The contacts on contactors K12 and K13 are monitored in the safety relay's feedback circuit Y1-Y2.

Safety assessment

- ▶ The safety relay PNOZ X10.11P (K11) and contactors K12, K13 must be installed in a single mounting area (control cabinet) in order to exclude a short across the output.
- ▶ Earth faults and shorts between contacts in the input circuit are detected via the light curtain.
- ▶ A fault on the device does not lead to the loss of the safety function.
- ▶ A single fault in the light curtain is detected.
- ▶ The device can be started when the input circuit is closed first, followed by reset button S11. This avoids an unwanted reset before the input circuit is closed or as a result of the reset button being overridden.

Pilz products

Number	Description	Order number
1	PNOZ X10.11P	777 750
1	PSEN op4F-s-14-090	630 605

PL e of EN ISO 13849-1, SIL 3 of EN 62061 PNOZ X10.11P – PSEN op4F-s light curtain

Safety-related characteristics in accordance with EN ISO 13849-1

Prerequisites:

- ▶ Common cause failure (CCF): Requirements are considered to be met (must be tested on implementation)
- ▶ Mission time: 20 years
- ▶ Operating interval (electromechanical components):
 - Actuator: Two operations per hour
- ▶ Characteristic data of contactors K12, K13: B10d: 2,000,000

EN ISO 13849-1		Performance Level	Safety-related parts of the control system
Safety function:	Machine shut down when the safety light curtain is interrupted	PL e	Sensor (PSEN op4F-s B1/B2) Logic (PNOZ X10.11P K11) Actuator (contactors K12, K13)

Please note the further requirements of EN ISO 13849-1, e.g. requirements for avoiding systematic faults.

Safety-related characteristics in accordance with EN 62061

Prerequisites:

- ▶ Common cause failure (CCF): $\beta = 2 \%$ (must be tested on implementation)
- ▶ Proof test interval: 20 years
- ▶ Operating interval (electromechanical components):
 - Actuator: Two operations per hour
- ▶ Characteristic data of contactors K12, K13: B10d: 2,000,000
Dangerous failure rate: 65%

EN 62061		Safety Integrity Level	Subsystems
Safety-related control function (SRCF):	Machine shut down when the safety light curtain is interrupted	SIL 3	Sensor (PSEN op4F-s B1/B2) Logic (PNOZ X10.11P K11) Actuator (contactors K12, K13)

Please note the further requirements of EN 62061, e.g. requirements for systematic safety integrity.

Classification in accordance with EN 954-1

Depending on the application area and its respective regulations, this connection example is suitable for applications up to Category 4 of EN 954-1.

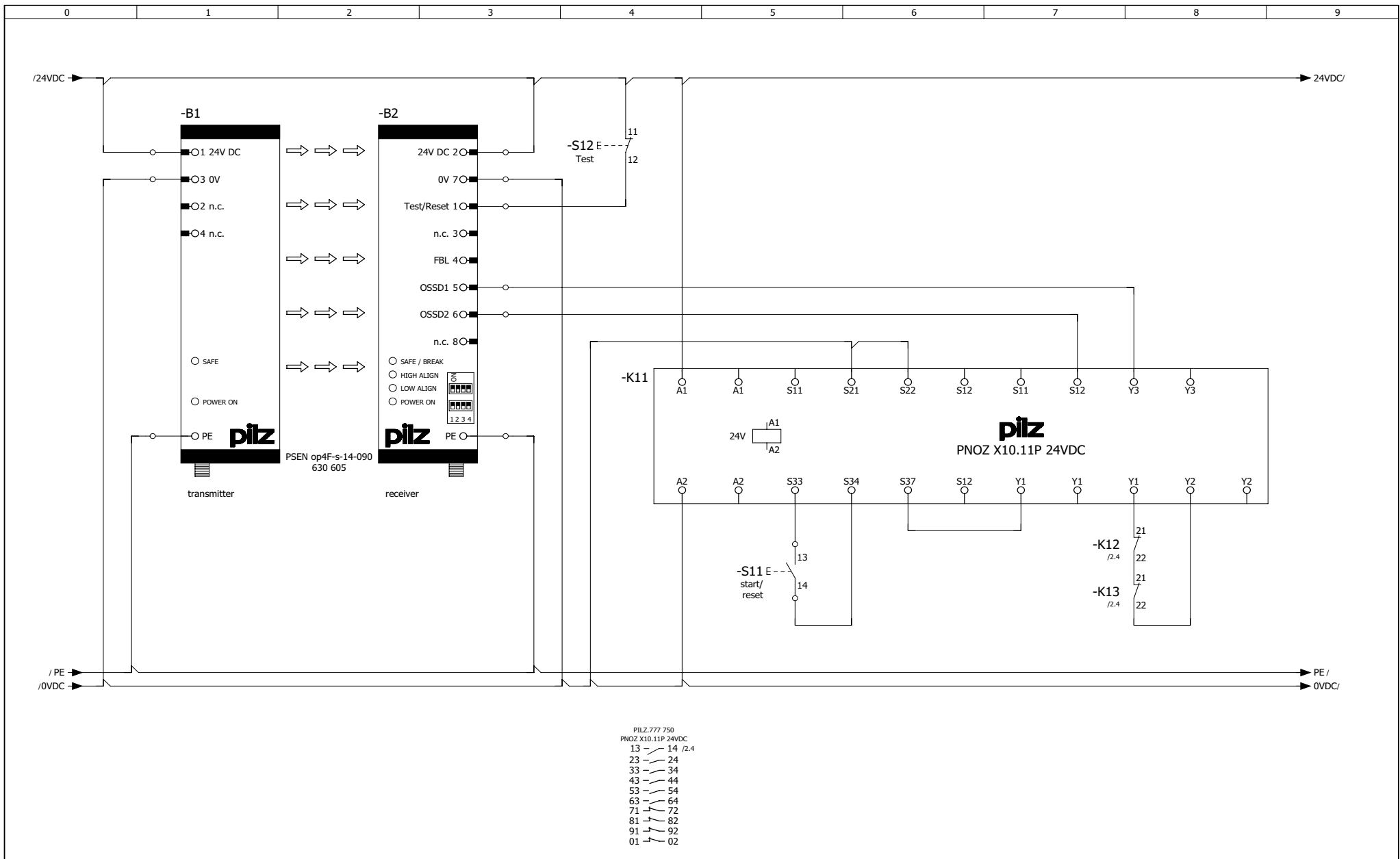

Revision	25.05.2009	Date	19.01.2005	EN ISO 13849-1:2008	PL e	Pilz GmbH & Co.KG Felix-Wankel-Str.2 73760 Ostfildern	ESPE PSEN op4 with monitored start of PNOZ X10.11P	Mounting place + PNOZX10.11P
Name	RDS	Name	WED	EN 62061:2005	SIL 3		Page:	1 / 2
		Dep.	CS					

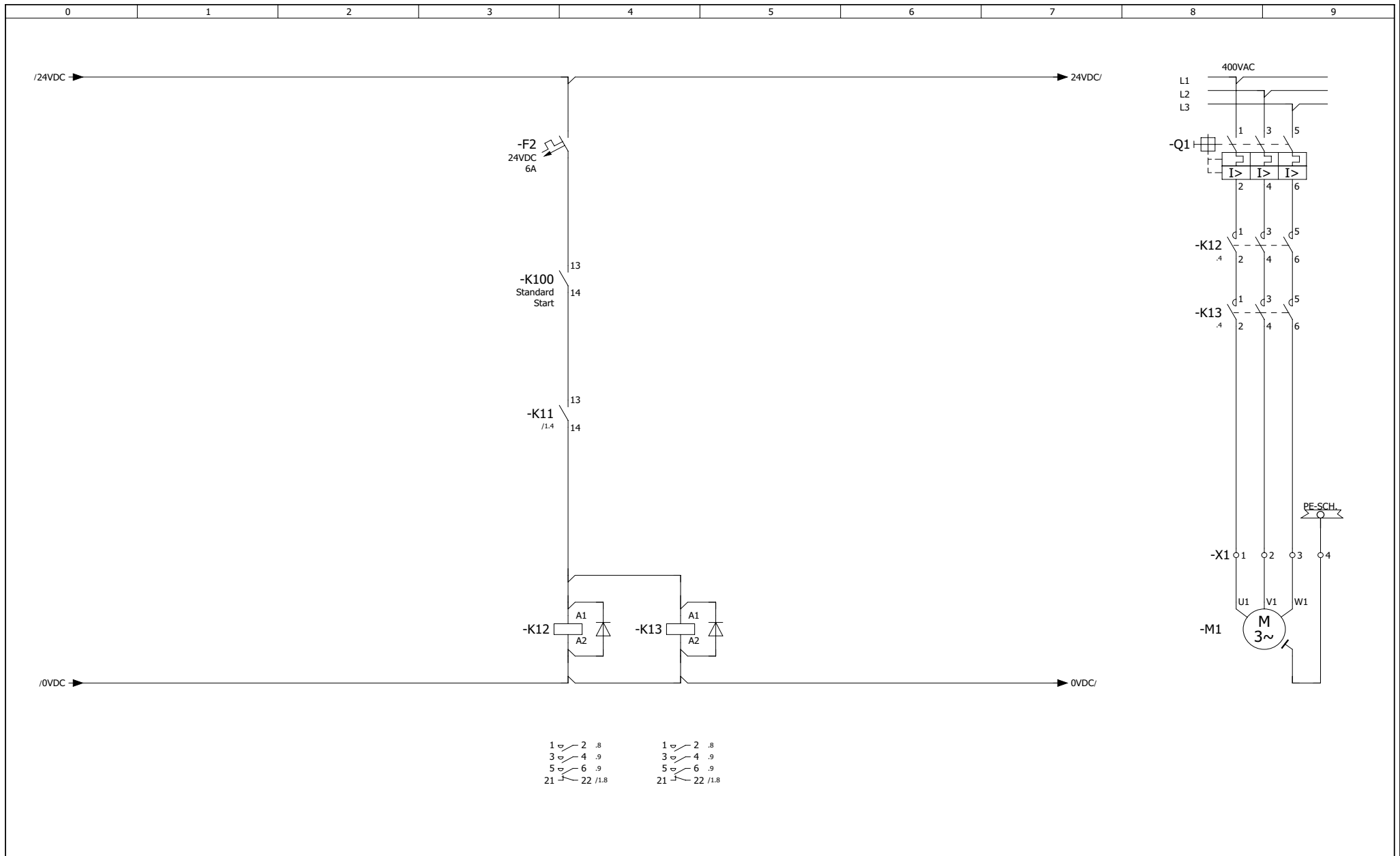

Revision	25.05.2009	Date	19.01.2005	EN ISO 13849-1:2008	PL e	 Pilz GmbH & Co.KG Felix-Wankel-Str.2 73760 Ostfildern	ESPE PSEN op4 with monitored start of PNOZ X10.11P	Mounting place + PNOZX10.11P
Name	RDS	Name	RDS	EN 62061:2005	SIL 3			Page: 2 / 2
		Dep.	CS					

Contents		Page
<hr/>		
Muting applications		
PNOZ X4	- T-Muting with PSEN op4B-T	PL e of EN ISO 13849-1, SIL 3 of EN 62061
		2.4-2
PNOZ X4	- L-Muting with PSEN op4B-L	PL e of EN ISO 13849-1, SIL 3 of EN 62061
		2.4-6

PL e of EN ISO 13849-1, SIL 3 of EN 62061 PNOZ X4 – T-Muting with PSEN op4B-T

Features

- ▶ Dual-channel operation with detection of shorts across contacts via light curtain
- ▶ With integrated muting sensors and muting lamps
- ▶ Muting possible in two directions (T-Muting)
- ▶ Automatic reset on light curtain
- ▶ Monitored reset on PNOZ
- ▶ Light curtain with semiconductor output
- ▶ Contact expansion through positive-guided contactors
- ▶ Feedback circuit to monitor contact expansion

Description

AOPD function

The interruption of the light curtain is signalled to the safety relay PNOZ X4 (K1) via the two semiconductor outputs on receiver B2.

The semiconductor outputs on the safety light curtain's receiver B2 are opened as soon as the light curtain is interrupted. This interrupts the input circuit on the safety relay PNOZ X4 and the safety contacts open. Contactors KM1 and KM2 de-energise.

Muting function

Correct switching of the muting sensors must allow the protected field to be interrupted without shutting down the plant.

Both the muting sensors in B3 (A and B) must be operated consecutively within 4 s for muting to start. Muting is ended if just one muting sensor in B5 (A and B) is active. If the travel direction is reversed, both the muting sensors in B5 (A and B) must be operated consecutively within 4 s for muting to start. Muting is ended if just one muting sensor in B3 (A and B) is active. The required muting configuration can be set using the DIP switches on the receiver B2 (see operating instructions for PSEN op4B-T). A muting lamp is also integrated within the light curtain for use with the muting function. A flashing lamp indicates that the muting function has been activated successfully. If the simultaneity requirement (4 s) of the muting sensors in B3/B5 is exceeded, the semiconductor outputs are switched off and the light curtain goes to a fault condition. The override function (S2) can be used to clear material from the protected field (see operating instructions for PSEN op4B-T).

Start/reset

The safety relay PNOZ X4 (K1) can be started by pressing reset button S3 if:

- ▶ The muting sensors have not been activated and
- ▶ The semiconductor outputs on the safety light curtain (B1/B2) are closed and
- ▶ Contactors KM1 and KM2 have de-energised.

Feedback circuit

The positive-guided N/C contacts on contactors KM1 and KM2 are connected to feedback loop Y1/Y2 on safety relay PNOZ X4 (K1).

Safety assessment

- ▶ The safety relay PNOZ X4 (K1) and contactors KM1 and KM2 must be installed in a single mounting area (control cabinet) in order to exclude a short across the output.
- ▶ Earth faults and shorts between contacts in the input circuit are detected via the light curtain.
- ▶ A fault on the device does not lead to the loss of the safety function.
- ▶ A single fault in the light curtain is detected.

Pilz products

Number	Description	Order number
1	PNOZ X4	774 730
1	PSEN op4B-T-3-080	630 702

- ▶ The device can be started if the input circuit is closed first, followed by reset button S3. This avoids an unwanted reset before the input circuit is closed or as a result of the reset button being overridden.
- ▶ The muting sensors (B3 and B5) must be tested at appropriate intervals: an activated muting function must be deactivated within an appropriate time period (no continuous muting).
- ▶ The actuators (contactors) must be switched off periodically for fault detection.
- ▶ The override switch must be operated periodically for fault detection.

Muting applications

PL e of EN ISO 13849-1, SIL 3 of EN 62061

PNOZ X4 – T-Muting with PSEN op4B-T

Safety-related characteristics in accordance with EN ISO 13849-1

Prerequisites:

- ▶ Common cause failure (CCF): Requirements are considered to be met (must be tested on implementation)
- ▶ Mission time: 20 years
- ▶ Operating interval (electromechanical components):
 - Actuator: Two operations per hour
- ▶ Characteristic data of contactors KM1, KM2: B10d: 2,000,000

EN ISO 13849-1		Performance Level	Safety-related parts of the control system
Safety function 1:	Machine shut down when the safety light curtain is interrupted	PL e	Sensor (PSEN op4B-T) Logic (PNOZ X4 K1) Actuator (contactors KM1, KM2)
Safety function 2:	Temporary suspension of a safety device	PL e	Sensor/Logic (PSEN op4B-T)

Please note the further requirements of EN ISO 13849-1, e.g. requirements for avoiding systematic faults.

Safety-related characteristics in accordance with EN 62061

Prerequisites:

- ▶ Common cause failure (CCF): $\beta = 2 \%$ (must be tested on implementation)
- ▶ Proof test interval: 20 years
- ▶ Operating interval (electromechanical components):
 - Actuator: Two operations per hour
- ▶ Characteristic data of contactors KM1, KM2: B10d: 2,000,000
Dangerous failure rate: 65%

EN 62061		Safety Integrity Level	Subsystems
Safety-related control function (SRCF 1):	Machine shut down when the safety light curtain is interrupted	SIL 3	Sensor (PSEN op4B-T) Logic (PNOZ X4 K1) Actuator (contactors KM1, KM2)
Safety-related control function (SRCF 2):	Temporary suspension of a safety device	SIL 3	Sensor/Logic (PSEN op4B-T)

Please note the further requirements of EN 62061, e.g. requirements for systematic safety integrity.

Classification in accordance with EN 954-1

Depending on the application area and its respective regulations, this connection example is suitable for applications up to Category 4 of EN 954-1.

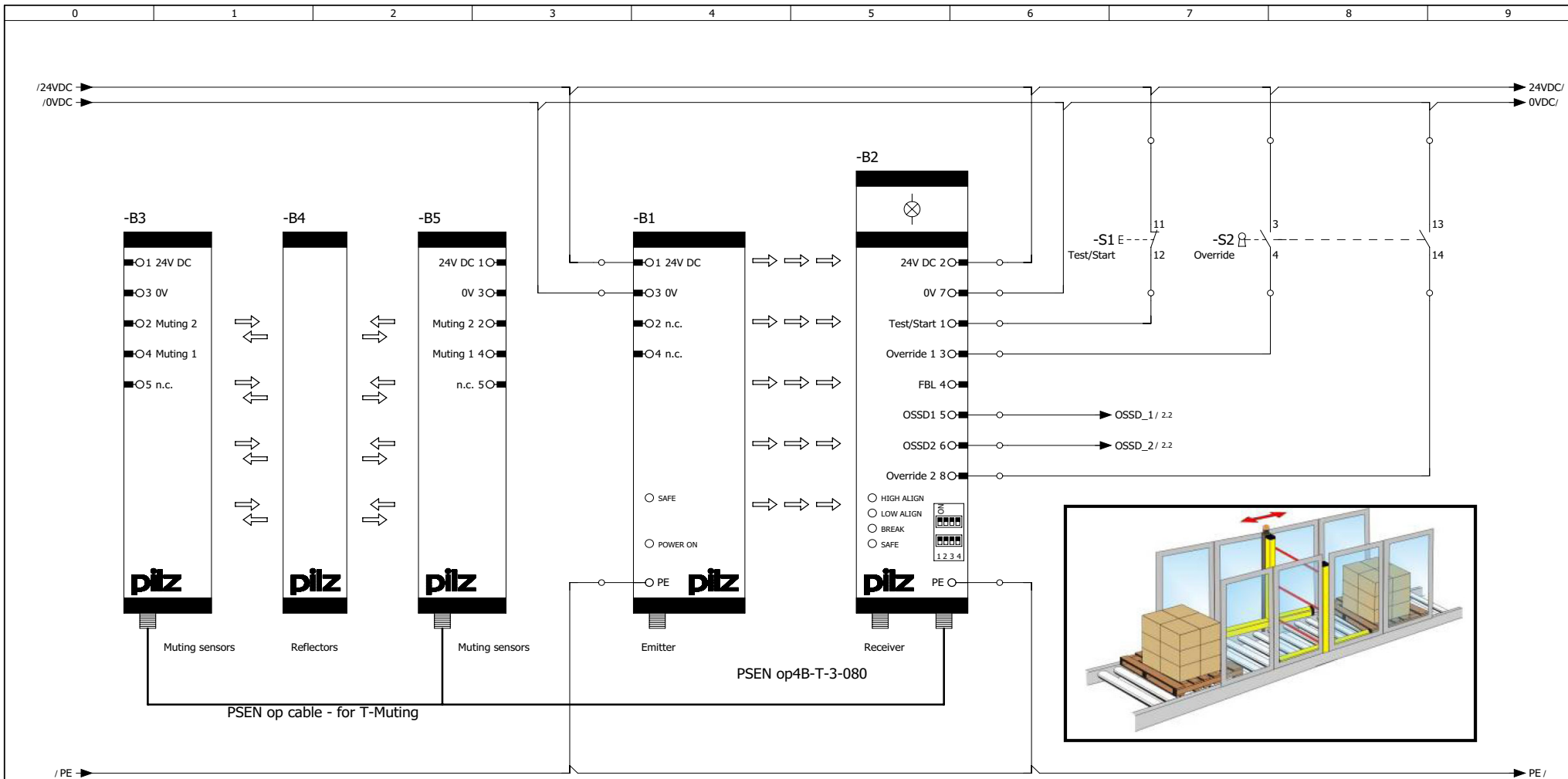

2.4

Revision	25.05.2009	Date	19.01.2005
Name	RDS	Name	RDS
		Dep.	CS

EN ISO 13849-1:2008	PL e
EN 62061:2005	SIL 3

pilz Pilz GmbH & Co.KG
Felix-Wankel-Str.2
73760 Ostfildern

T-Konfiguration with
PSEN op4B-T

Mounting place + PNOZX4 NEU
Page: 1 / 2

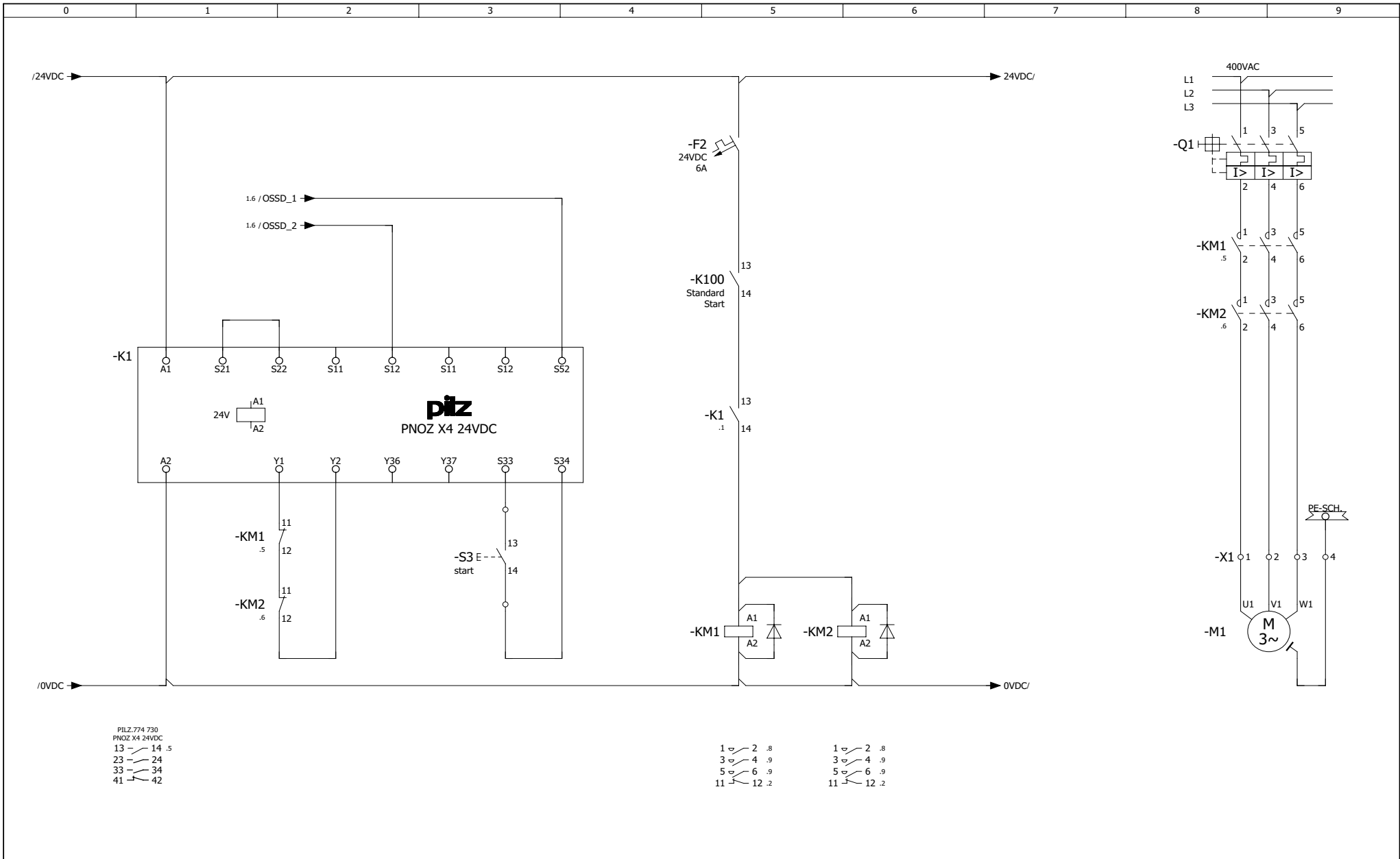

Revision	25.05.2009	Date	19.01.2005	EN ISO 13849-1:2008	PL e	 Pilz GmbH & Co.KG Felix-Wankel-Str.2 73760 Ostfildern	T-Konfiguration with PSEN op4B-T	Mounting place + PNOZX4 NEU
Name	RDS	Name	RDS	EN 62061:2005	SIL 3			Page: 2 / 2
		Dep.	CS					

PL e of EN ISO 13849-1, SIL 3 of EN 62061

PNOZ X4 – L-Muting with PSEN op4B-L

Features

- ▶ Dual-channel operation with detection of shorts across contacts via light curtain
- ▶ With integrated muting sensors and muting lamps
- ▶ Muting possible on leaving the danger zone (L-Muting)
- ▶ Automatic reset on light curtain
- ▶ Monitored reset on PNOZ
- ▶ Light curtain with semiconductor output
- ▶ Contact expansion through positive-guided contactors
- ▶ Feedback circuit to monitor contact expansion

Description

AOPD function

The interruption of the light curtain is signalled to the safety relay PNOZ X4 (K1) via the two semiconductor outputs on receiver B2.

The semiconductor outputs on the safety light curtain's receiver B2 are opened as soon as the light curtain is interrupted. This interrupts the input circuit on the safety relay PNOZ X4 and the safety contacts open. Contactors KM1 and KM2 de-energise.

Muting function

Correct switching of the muting sensors must allow the protected field to be interrupted without shutting down the plant.

Both the muting sensors in B3 must be operated consecutively within 4 s for muting to start. The muting function is maintained for 4 s after muting sensor "A" is released. After this time the muting function switches off and the safety light curtain returns to normal mode.



CAUTION!

You should also secure the area around the light curtain outside the danger zone, with a safety fence for example, so that nobody can access the danger zone during the 4 s period in which the muting function is maintained.

The required muting configuration can be set using the DIP switches on the receiver B2 (see operating instructions for PSEN op4B-L).

A muting lamp is also integrated within the light curtain for use with the muting function. A flashing lamp indicates that the muting function has been activated successfully.

If the simultaneity requirement (4 s) of the muting sensors in B3 is exceeded, the semiconductor outputs are switched off and the light curtain goes to a fault condition. The override function (S2) can be used to clear material from the protected field (see operating instructions for PSEN op4B-L).

Start/reset

The safety relay PNOZ X4 (K1) can be started by pressing reset button S3 if:

- ▶ The muting sensors have not been activated and
- ▶ The semiconductor outputs on the safety light curtain (B1/B2) are closed and
- ▶ Contactors KM1 and KM2 have de-energised.

Feedback circuit

The positive-guided N/C contacts on contactors KM1 and KM2 are connected to feedback loop Y1/Y2 on safety relay PNOZ X4 (K1).

Safety assessment

- ▶ L-configuration muting is suitable for applications in which the object is to be transported out of the danger zone.
- ▶ The safety relay PNOZ X4 (K1) and contactors KM1 and KM2 must be installed in a single mounting area (control cabinet) in order to exclude a short across the output.

Pilz products

Number	Description	Order number
1	PNOZ X4	774 730
1	PSEN op4B-L-3-080	630 704

- ▶ Earth faults and shorts between contacts in the input circuit are detected via the light curtain.
- ▶ A fault on the device does not lead to the loss of the safety function.
- ▶ A single fault in the light curtain is detected.
- ▶ The device can be started if the input circuit is closed first, followed by reset button S3. This avoids an unwanted reset before the input circuit is closed or as a result of the reset button being overridden.
- ▶ The muting sensors (B3) must be tested at appropriate intervals: an activated muting function must be deactivated within an appropriate time period (no continuous muting).
- ▶ The actuators (contactors) must be switched off periodically for fault detection.
- ▶ The override switch must be operated periodically for fault detection.

Muting applications

PL e of EN ISO 13849-1, SIL 3 of EN 62061 PNOZ X4 – L-Muting with PSEN op4B-L

Safety-related characteristics in accordance with EN ISO 13849-1

Prerequisites:

- ▶ Common cause failure (CCF): Requirements are considered to be met (must be tested on implementation)
- ▶ Mission time: 20 years
- ▶ Operating interval (electromechanical components):
 - Actuator: Two operations per hour
- ▶ Characteristic data of contactors KM1, KM2: B10d: 2,000,000

EN ISO 13849-1		Performance Level	Safety-related parts of the control system
Safety function 1:	Machine shut down when the safety light curtain is interrupted	PL e	Sensor (PSEN op4B-L) Logic (PNOZ X4 K1) Actuator (contactors KM1, KM2)
Safety function 2:	Temporary suspension of a safety device	PL e	Sensor/Logic (PSEN op4B-L)

Please note the further requirements of EN ISO 13849-1, e.g. requirements for avoiding systematic faults.

Safety-related characteristics in accordance with EN 62061

Prerequisites:

- ▶ Common cause failure (CCF): $\beta = 2 \%$ (must be tested on implementation)
- ▶ Proof test interval: 20 years
- ▶ Operating interval (electromechanical components):
 - Actuator: Two operations per hour
- ▶ Characteristic data of contactors KM1, KM2: B10d: 2,000,000
Dangerous failure rate: 65%

EN 62061		Safety Integrity Level	Subsystems
Safety-related control function (SRCF 1):	Machine shut down when the safety light curtain is interrupted	SIL 3	Sensor (PSEN op4B-L) Logic (PNOZ X4 K1) Actuator (contactors KM1, KM2)
Safety-related control function (SRCF 2):	Temporary suspension of a safety device	SIL 3	Sensor/Logic (PSEN op4B-L)

Please note the further requirements of EN 62061, e.g. requirements for systematic safety integrity.

Classification in accordance with EN 954-1

Depending on the application area and its respective regulations, this connection example is suitable for applications up to Category 4 of EN 954-1.

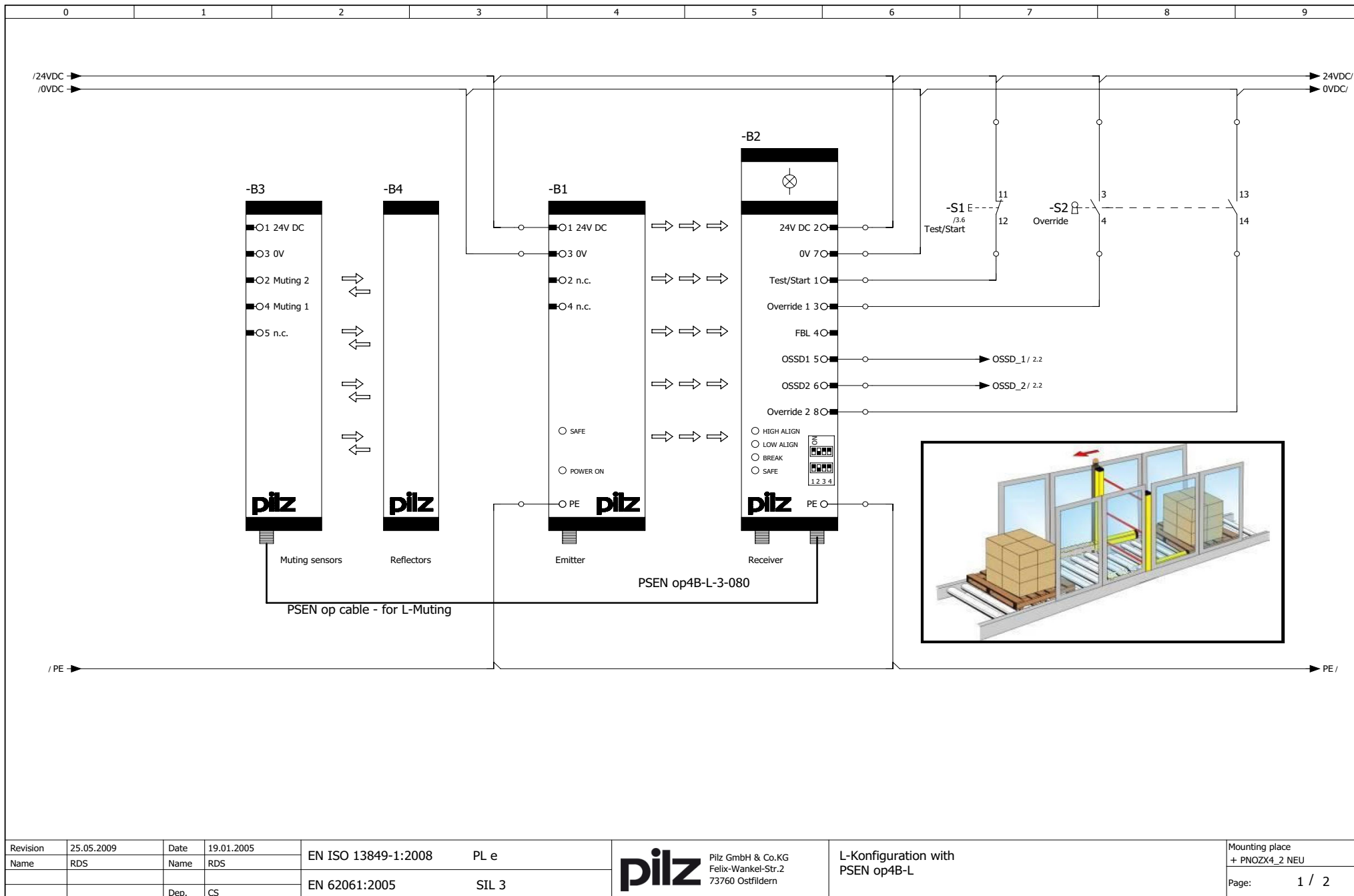

Revision	25.05.2009	Date	19.01.2005	EN ISO 13849-1:2008	PL e	Pilz GmbH & Co.KG Felix-Wankel-Str.2 73760 Ostfildern	L-Konfiguration with PSEN op4B-L	Mounting place + PNOZX4_2 NEU
Name	RDS	Name	RDS	EN 62061:2005	SIL 3			Page: 1 / 2
		Dep.	CS					

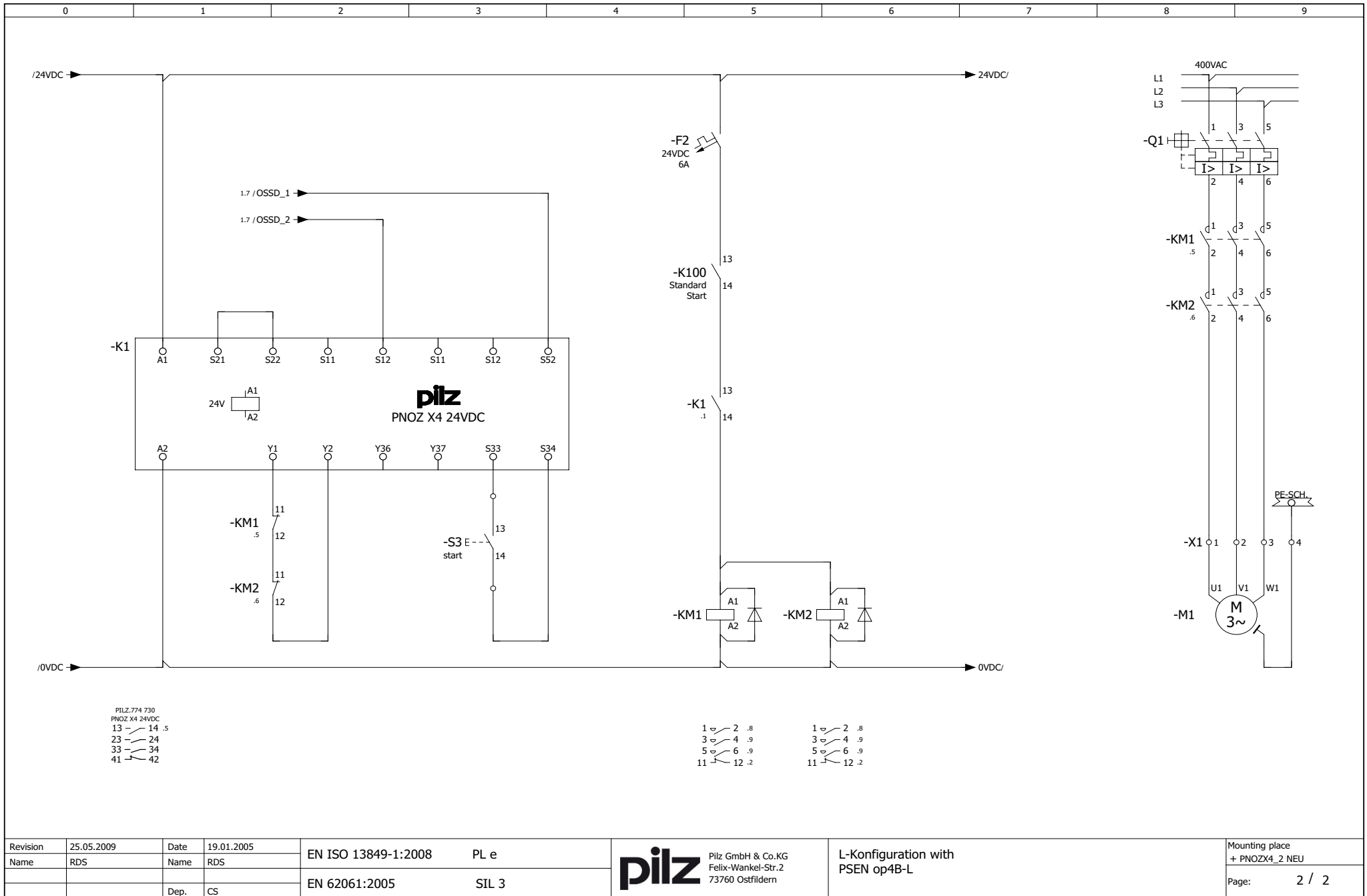

Revision	25.05.2009	Date	19.01.2005	EN ISO 13849-1:2008	PL e	Pilz GmbH & Co.KG Felix-Wankel-Str.2 73760 Ostfildern	L-Konfiguration with PSEN op4B-L	Mounting place + PNOZX4_2 NEU
Name	RDS	Name	RDS	EN 62061:2005	SIL 3			Page: 2 / 2
		Dep.	CS					

Contents	Page
Service	
Pre-sales/after sale	
	Professional services 3.1-2
Your partner for practical training	
	Customised training concepts 3.1-3
Business terms and conditions	
	Delivery and payment-terms 3.1-4

Pre-sales/after sales Professional services



We can provide consulting and engineering, training and support, from the project configuration phase through to commissioning.



Risk Assessment

Assessment of the hazards and risks on plant and machinery, based on norms and standards.



Safety Concept

Based on the risk analysis, appropriate protective measures can be selected and a safety concept drawn up.



Safety Design

As part of the safety design, Pilz produces detailed documentation regarding the implementation, taking into account the safety concept.



System Implementation

Pilz undertakes all the tasks required to implement a project: component selection, preparation of circuit diagrams, programming, control cabinet, installation, commissioning.



Safety Validation

All the relevant safety-related documents are examined, check lists are created and the plant and machinery checked.



CE Marking

Co-ordination and implementation of all the activities necessary for the CE conformity of plant and machinery.



Plant Assessment

Analysis and assessment of the safety-related condition of your plant and machinery. Proposal of basic recommendations for improvement.



Training and Education

A wide range of seminars and training courses on machinery safety helps to communicate the fundamentals for minimising risk and assuring your success.



Technical Support

Our engineers can support you in the selection, use and application of our products. They are in constant contact with customers from the widest range of areas and industrial sectors and are happy to answer your queries at any time.



E-Mail:
support@pilz.com



24-hour hotline:
+49 711 3409-444



Supply and Repair Service

From a fast, economical repair through to a long supply guarantee to safeguard your investment – always expect more from Pilz.



Certificates and Approvals

Pilz is certified to DIN ISO 9001. International approvals and certification from recognised test houses confirm our products' suitability for worldwide use.



Internet

Our homepage at www.pilz.com provides the latest information, electronic shopping, direct dialogue and enquiry functions as well as extensive download options.



E-Business

The focus of Pilz's E-Business activities is to strengthen customer orientation through the use of new media and to increase added value via a supplementary business model for Business-to-Business.



Worldwide Representatives

Our worldwide network of subsidiaries and sales partners ensures comprehensive support and assistance with your questions and problems.

Your partner for practical training

Customised training concepts



Benefit from the expertise of one of the leading brands in automation technology

As a result of many years' experience, work with the standards' committees and thorough expertise in the area of safe automation technology, Pilz is the ideal partner for practical training. Pilz offers a large number of seminars and courses on the widest range of subjects to both manufacturers and users alike – worldwide, in various languages, to the same standard. For example:

- ▶ General safety-related issues
- ▶ New machinery safety standards
- ▶ Programming and maintenance
- ▶ Error evaluation and diagnostics



Whether you need a basic seminar or an advanced course, we can help to prepare you individually in the best way possible for everyday work situations. We will happily do this at your premises, directly on the machine.

More information on our complete seminar program, conditions of registration and seminar venues can be found on the Internet, where you also have the opportunity to register directly online:

▶ www.pilz.com

Why not find out more about our attractive range of training courses!



Business terms and conditions

Terms of delivery and payment



The terms of delivery and of payment of the respective Pilz company with whom a sales contract is closed are applied. As a rule this is the Pilz company that places the order. Please select the legal contract partner from the order confirmation.

▶ AT

Pilz Ges.m.b.H.
Sichere Automation
Modecenterstraße 14
1030 Wien
Austria
Telephone: +43 1 7986263-0
Telefax: +43 1 7986264
E-Mail: pilz@pilz.at
Internet: www.pilz.at

▶ AU

Pilz Australia
Safe Automation
Suite C1, 756 Blackburn Road
Clayton, Melbourne VIC 3168
Australia
Telephone: +61 3 95446300
Telefax: +61 3 95446311
E-Mail: safety@pilz.com.au
Internet: www.pilz.com.au

▶ BE ▶ LU

Pilz Belgium
Safe Automation
Bijenstraat 4
9051 Gent (Sint-Denijs-Westrem)
Belgium
Telephone: +32 9 3217570
Telefax: +32 9 3217571
E-Mail: info@pilz.be
Internet: www.pilz.be

▶ BR

Pilz do Brasil
Automação Segura
Rua Ártico, 123 - Jd. do Mar
09726-300
São Bernardo do Campo - SP
Brazil
Telephone: +55 11 4337-1241
Telefax: +55 11 4337-1242
E-Mail: pilz@pilz.com.br
Internet: www.pilz.com.br

▶ CH

Pilz Industrieelektronik GmbH
Gewerbepark Hintermättli
Postfach 6
5506 Mägenwil
Switzerland
Telephone: +41 62 88979-30
Telefax: +41 62 88979-40
E-Mail: pilz@pilz.ch
Internet: www.pilz.ch

▶ CN

Pilz Industrial Automation
Trading (Shanghai) Co., Ltd.
Safe Automation
Rm. 704-706
No. 457 Wu Lu Mu Qi (N) Road
Shanghai 200040
China
Telephone: +86 21 62494658
Telefax: +86 21 62491300
E-Mail: sales@pilz.com.cn
Internet: www.pilz.com.cn

▶ DE

Pilz GmbH & Co. KG
Felix-Wankel-Straße 2
73760 Ostfildern
Germany
Telephone: +49 711 3409-0
Telefax: +49 711 3409-133
E-Mail: pilz.gmbh@pilz.de
Internet: www.pilz.de

▶ DK

Pilz Skandinavien K/S
Safe Automation
Ellegaardvej 25 L
6400 Sønderborg
Denmark
Telephone: +45 74436332
Telefax: +45 74436342
E-Mail: pilz@pilz.dk
Internet: www.pilz.dk

▶ ES

Pilz Industrieelektronik S.L.
Safe Automation
Cami Ral, 130
Polígono Industrial Palou Nord
08401 Granollers
Spain
Telephone: +34 938497433
Telefax: +34 938497544
E-Mail: pilz@pilz.es
Internet: www.pilz.es

▶ FI

Pilz Skandinavien K/S
Safe Automation
Nuijamiestentie 7
00400 Helsinki
Finland
Telephone: +358 9 27093700
Telefax: +358 9 27093709
E-Mail: pilz.fi@pilz.dk
Internet: www.pilz.fi

▶ FR

Pilz France Electronic
1, rue Jacob Mayer
BP 12
67037 Strasbourg Cedex 2
France
Telephone: +33 3 88104000
Telefax: +33 3 88108000
E-Mail: siege@pilz-france.fr
Internet: www.pilz.fr

▶ GB

Pilz Automation Technology
Safe Automation
Willow House, Medicott Close
Oakley Hay Business Park
Corby
Northants NN18 9NF
United Kingdom
Telephone: +44 1536 460766
Telefax: +44 1536 460866
E-Mail: sales@pilz.co.uk
Internet: www.pilz.co.uk

▶ IE

Pilz Ireland Industrial Automation
Cork Business and Technology Park
Model Farm Road
Cork
Ireland
Telephone: +353 21 4346535
Telefax: +353 21 4804994
E-Mail: sales@pilz.ie
Internet: www.pilz.ie

▶ IT

Pilz Italia Srl
Automazione sicura
Via Meda 2/A
22060 Novedrate (CO)
Italy
Telephone: +39 031 789511
Telefax: +39 031 789555
E-Mail: info@pilz.it
Internet: www.pilz.it

▶ JP

Pilz Japan Co., Ltd.
Safe Automation
Shin-Yokohama Fujika Building 5F
2-5-9 Shin-Yokohama
Kohoku-ku
Yokohama 222-0033
Japan
Telephone: +81 45 471-2281
Telefax: +81 45 471-2283
E-Mail: pilz@pilz.co.jp
Internet: www.pilz.jp

▶ KR

Pilz Korea Ltd.
Safe Automation
9F Jo-Yang Bld. 50-10
Chungmuro2-Ga Jung-Gu
100-861 Seoul
Republic of Korea
Telephone: +82 2 2263 9541
Telefax: +82 2 2263 9542
E-Mail: info@pilzkorea.co.kr
Internet: www.pilzkorea.co.kr

▶ ...

In many countries we are represented by sales partners.

Please refer to our homepage for further details or contact our headquarters.

▶ MX

Pilz de México, S. de R.L. de C.V.
Automatización Segura
Circuito Pintores 170
Cd. Satélite
Naucalpan, Méx. 53100
Mexico
Telephone: +52 55 5572 1300
Telefax: +52 55 5572 1300
E-Mail: info@mx.pilz.com
Internet: www.pilz.com.mx

▶ NL

Pilz Nederland
Veilige automatisering
Postbus 186
4130 ED Vianen
Netherlands
Telephone: +31 347 320477
Telefax: +31 347 320485
E-Mail: info@pilz.nl
Internet: www.pilz.nl

▶ NZ

Pilz New Zealand
Safe Automation
5 Nixon Road
Mangere
Auckland
New Zealand
Telephone: +64 9 6345350
Telefax: +64 9 6345352
E-Mail: t.catterson@pilz.co.nz
Internet: www.pilz.co.nz

▶ PL

Pilz Polska Sp. z o.o.
Safe Automation
ul. Marywilska 34H
03-231 Warszawa
Poland
Telephone: +48 22 8847100
Telefax: +48 22 8847109
E-Mail: info@pilz.pl
Internet: www.pilz.pl

▶ Technical support

+49 711 3409-444
support@pilz.com

▶ PT

Pilz Industrieelektronik S.L.
R. Eng Duarte Pacheco, 120
4 Andar Sala 21
4470-174 Maia
Portugal
Telephone: +351 229407594
Telefax: +351 229407595
E-Mail: pilz@pilz.es
Internet: www.pilz.es

▶ RU

Pilz Russia
Mjachkovsky bulvar d.31/19 office 2
Moscow 109469
Russian Federation
Telephone: +7 495 346 4110
E-Mail: pilz@pilzrussia.ru
Internet: www.pilzrussia.ru

▶ SE

Pilz Skandinavien K/S
Safe Automation
Energigatan 10 B
43437 Kungsbacka
Sweden
Telephone: +46 300 13990
Telefax: +46 300 30740
E-Mail: pilz.se@pilz.dk
Internet: www.pilz.se

▶ TR

Pilz Emniyet Otomasyon
Ürünleri ve Hizmetleri Tic. Ltd. Şti.
Kayışdağı Cd. Beykonağı Plaza
No:130 K:2 D:2
Ataşehir/İstanbul
Turkey
Telephone: +90 216 5775550
Telefax: +90 216 5775549
E-Mail: info@pilz.com.tr
Internet: www.pilz.com.tr

▶ US ▶ CA

Pilz Automation Safety L.P.
7150 Commerce Boulevard
Canton
Michigan 48187
USA
Telephone: +1 734 354 0272
Telefax: +1 734 354 3355
E-Mail: info@pilzusa.com
Internet: www.pilz.us



Pilz GmbH & Co. KG
Felix-Wankel-Straße 2
73760 Ostfildern, Germany
Telephone: +49 711 3409-0
Telefax: +49 711 3409-133
E-Mail: pilz.gmbh@pilz.de
Internet: www.pilz.com

pilz