

Digital Fiber Sensor D2RF series



Digital Fiber Amplifier with Two Independent Outputs.
High speed 60 micro second response.

6 teach methods for individual applications

Full Power Teaching

Standard detection mode for Thru-beam type sensing but applicable for retro-reflective sensing also.



Full automatic Teaching

Set while the equipment is operating.



Single point Teaching

Set without a target present.



Transparent / Glass Teaching

Ideal for the detection of glass, film, plastic or any transparent material.



Two points Teaching

Standard detection mode for Diffuse type sensing. It is possible to make fine adjustments.



Zone Teaching

Similar to Area Teach Mode. This is useful if the conveyor moves closer to and farther from the sensor. An area +/- 10% of the teach point can be detected.

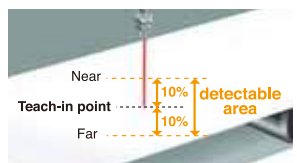

SAM Circuit - The ASC function (Auto Sensitivity Control)

Our engineer "SAM" designed this function. The lens and/or reflector may be contaminated over time. The D2RF amplifier monitors the change in light level and automatically resets the threshold value.

After cleaning off the lens / reflector it used to be necessary to reset the threshold setting. The D2RF does not require this step. Simply clean off the lens and wait three seconds without a target present. The sensor will automatically reset the threshold level for the change. This is how the SAM circuit works.

After cleaning the incoming light level will increase suddenly. The SAM circuit computes the preset threshold based on the increase in light intensity. This function is available only in Transparent Detection Mode.

Conventional Sensor

Contamination on the lens will eventually cause the sensor to malfunction.

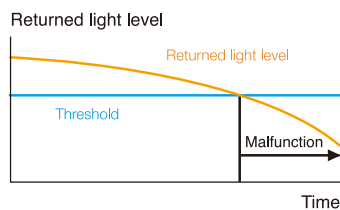

D2RF series SAM Circuit

The threshold will auto-matically return to the preset level after the lens is cleaned off.

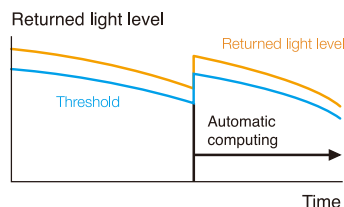

APC Function (Auto Power Control)

The APC function ensures precise sensing even when there are changes in the temperature or environmental conditions.

APC maintains a constant power level of light emission by regulating the current flow into the light emission element. The APC function can be turned On and Off.

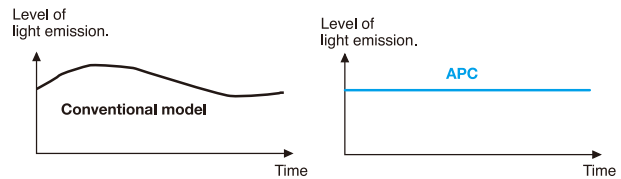

Two four digit display's.

Received Light Level and Threshold Setting

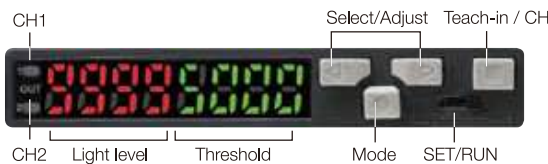

IP66 and IP50, two types.

If your application is around water or high humidity. There is a model of the D2RF-T series with an IP66 rating.



Long Term Stable Detection.

A conventional 3 element LED will lose brightness over time. This results in a decrease in sensitivity in the sensor. Optex FA's new D2RF uses a 4 element LED to provide long service life. The Green LED type D2GF uses a "Glan N2" LED, which offers the best performance for Mark Detection with a Green LED light source.

60 micro second high speed response.

Both outputs can be set to operate at this speed. This response time is available in 5 of the teach modes.



LED Power adjustment - 3 step adjustment of LED emitting power.

A highly reflective target will cause the amplifier to saturate making adjustment difficult. This can also happen if the fiber cable is mounted too close to the target.

In situations where the amplifier is saturated due to excessive reflected light, the power level of the emitting LED can be decreased to 50 or 25 percent.

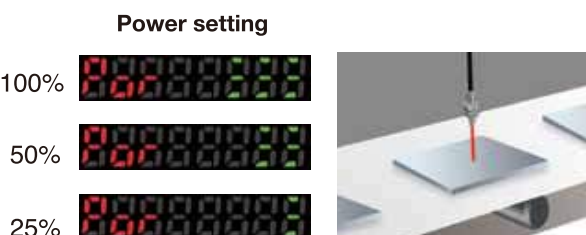

Cross Talk Prevention

The amplifier frequencies are automatically set between the Master and Slave units. Cross talk prevention is possible for up to 4 amplifiers.



Automatic Tuning

This provides a way to boost or dampen the excess gain level of the amplifier in poor sensing conditions (low light level, low sensitivity or saturating condition). Automatic Tuning is ideal when you need a little bit better excess gain level, or when detecting a dark object with diffuse reflective fiber cables.

Amplifiers

Various Shapes for mounting

Tight Bend / High-Flex

Various Detecting Modes

Environment-resistant

Liquid

Extension lens

Notes

Counter Mode

The D2RF amplifier features a built-in counter. This makes it convenient to count parts, for example 10 pcs. in a bag. The output turns on once the sensor has counted the desired quantity. Simply program in the number of parts to count.

Normal Mode:

An output comes as the sensor counts.

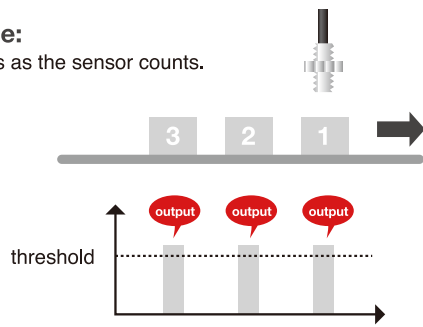

Counter Mode:

An output comes only when the preset numbers are counted. (Max 9999)

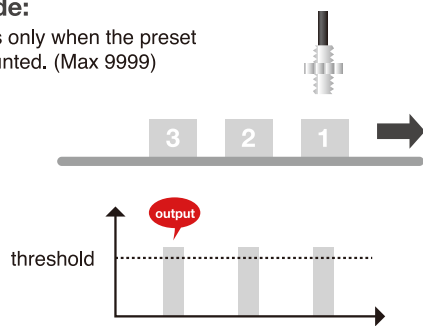

Edge Sensing

The sensor output triggers when there is a sudden increase or decrease in the light level. This is ideal for sensing objects without being influenced by a dusty environment.

Rising Edge Sensing Mode



Falling Edge Sensing Mode



Zero Reset

The sensor display can be reset to zero. This is useful for adjusting the display's of the Master and Slave units to read the same. It is also good to set the value to zero when the light is interrupted.

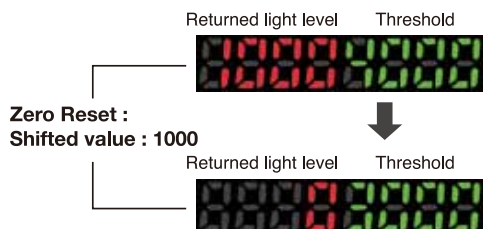

Differential Sensing Mode

A bumpy conveyor always makes stable detection difficult. The D2RF-T solves this problem with the Differential Sensing Mode. The Master and Slave amplifiers will calculate the difference between the reflection from the background and the target (see picture below). No matter how much the surface of the conveyor moves up and down the D2RF-T can follow the change and reliably detect the target.

Operation Flow:

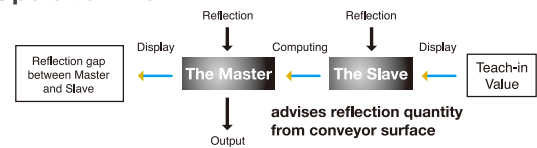

How to follow the changing condition!

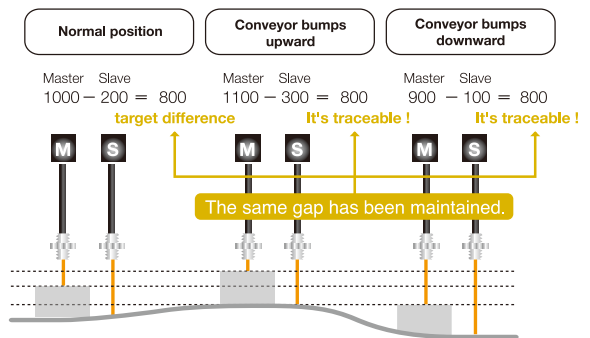

Selectable Response Time

The Response time will affect the sensing distance. The D2RF-T has three choices (Long, Standard, and Fast), select the response time based on the required sensing distance.

Long Mode boosts the power for the maximum sensing distance with a 2 msec. response time.

The Fast Mode has a reduced sensing distance but provides high speed 60µsec. response.

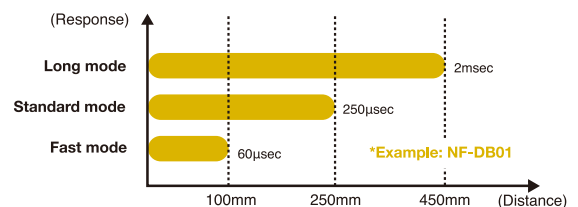

Long mode



Standard mode



Fast mode



Two Independent Outputs. Each output can be set separately.

The 2nd output can be configured as an external Teach input.

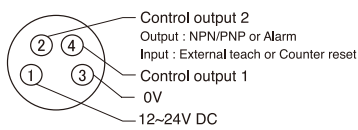
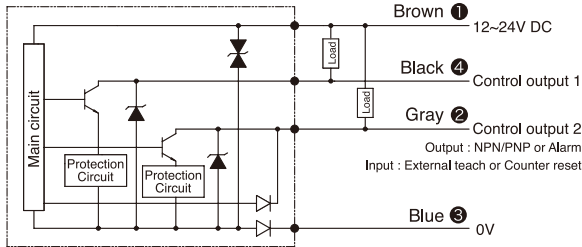

The operation of each output can be set to Light-On / Dark-On. Also, the Threshold level, Timer settings, etc. of each output can be set independently. The Analog output type (D2RF-TAN/P) provides a 4 ~ 20 mA (gray wire) analog output and a NPN (or PNP) digital output (black wire).

The second output can be configured as an Alarm output (self-diagnostic). It can also be set to operate as an External Teach Input or Counter Reset Input if the Counter function is being used.

External Teach Input (CH2)

It is possible to have a Remote Teach Input if the CH2 output is re-assigned as an input.

When using the Remote Teach with Interconnected amplifiers all units will perform the Teach function simultaneously.

(This function is not available for Analogue Type)

Amplifiers

Various Shapes for mounting

Tight Bend / High-Flex

Various Detecting Modes

Environment-resistant

Liquid

Extension lens

Notes

Dimensions

Stand-alone model

D2RF-T□
D2GF-T□

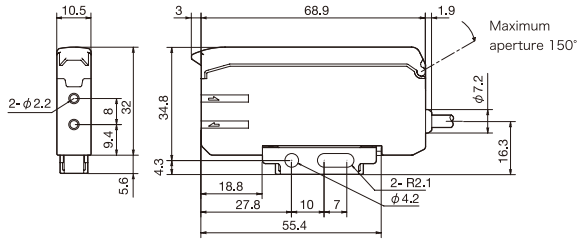
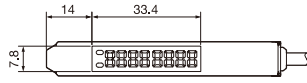

D2RF-TC□4
D2GF-TC□4

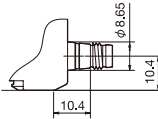

D2RF-2T□
D2GF-2T□

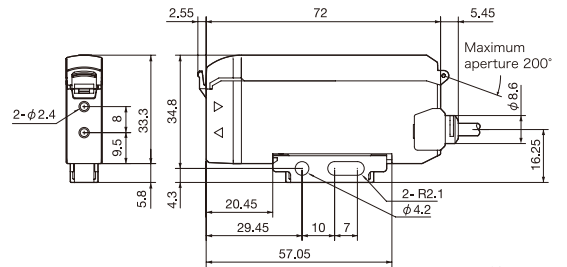
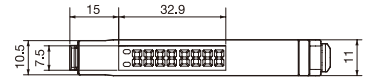

•D2RF-2TC□3/4
•D2GF-2TC□3/4

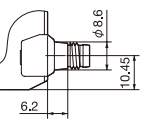

Interconnection model

D2□F-TM□
D2□F-TMC□4

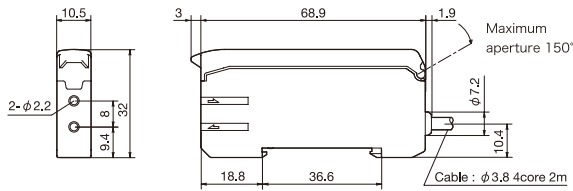
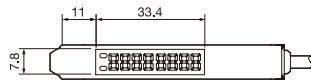

D2□F-TS□
D2□F-TSC□4

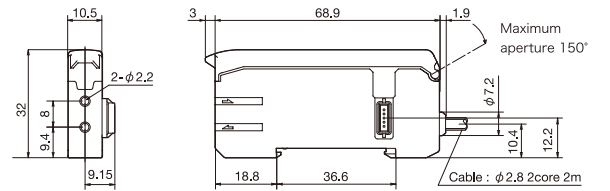
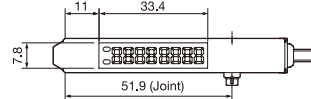

•M8 Connector type

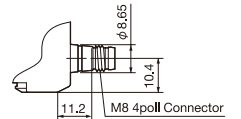

Analogue model

D2RF-TA□

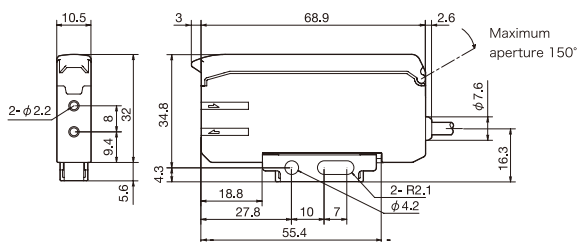
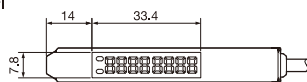

D2RF-2TA□

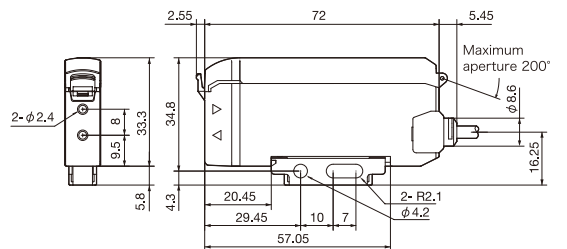
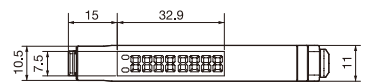

Amplifiers

Various Shapes for mounting

Tight Bend / High-Flex

Various Detecting Modes

Environment-resistant

Liquid

Extension lens

Notes

Specifications

Model	Standard	Mark sensor	Analogue
Stand-alone Type			
IP50 type	Cable type NPN / PNP	D2RF-TN / TP	D2GF-TN / TP
	M8 QD 4pin, NPN / PNP	D2RF-TCN4 / TCP4	D2GF-TCN4 / TCP4
IP66 type	Cable type NPN / PNP	D2RF-2TN / 2TP	D2GF-2TN / 2TP
	M8 QD 4pin, NPN / PNP	D2RF-2TCN4 / 2TCP4	D2GF-2TCN4 / 2TCP4
	M8 QD 3pin, NPN / PNP	D2RF-2TCN3 / 2TCP3	D2GF-2TCN3 / 2TCP3
Interconnection Type			
Master unit	Cable type NPN / PNP	D2RF-TMN / TMP	D2GF-TMN / TMP
	M8 QD 4pin, NPN / PNP	D2RF-TMCN4 / TMCP4	D2GF-TMCN4 / TMCP4
Slave unit	Cable type NPN / PNP	D2RF-TSN / TSP	D2GF-TSN / TSP
	M8 QD 4pin, NPN / PNP	D2RF-TSCN4 / TSCP4	D2GF-TSCN4 / TSCP4
Light source	Red LED	Green LED	Red LED
Response time	60 micro sec (Fast mode), 250 micro sec (standard), 2.0 ms (Long distance)		
Auto control system	APC / ASC		
LED Power control	3 steps ; 100%, 50% and 25%		
Timer functions	On delay/Off delay /One shot, 1-9,999msec (1msec increment)		
Sensitivity adjustment	Teach-in + fine adjustment		
Output indicator	Output (orange) : 1CH / 2CH common		Output (orange)
Digital indicator	7 segment LED, 4 digits in Red, 4 digits in Green		
Teach-in mode	Full Power / One point / Two points / Full Automatic / Differential / Zone / Transparent		
Control output	2CH, NPN or PNP open collector, DC30V, 100mA Max		1CH, NPN or PNP
Analogue output	NA		4-20mA, Resolution 0.1%FS
Parallel installation	Up to 16 sets		
Crosstalk prevention	Up to 4 sets		
Operating mode	Light on / Dark on selectable		
Sensing mode	Long Distance Mode, Standard, Fast mode,		
Display	Regular display plus ; bar, %, eco (off, run mode only)		
External input	Teaching / Counter Reset		
Supply voltage	DC 10-24V +/- 10% ripple		
Power consumption	45mA Max (24V)		
Circuit protection	Reverse Polarity, Overcurrent, Short circuit		
Warm-up time	100m sec		
Operating temp / humidity	-25 to 55°C, 35 to 85% RH		
Storage temp / humidity	-40 to 70°C, 35 to 85% RH		
Environmental illuminance	Sunlight 10,000 lux, High Frequency Lamp 3,000 lux		
Protection category	IEC, IP50 (except Stand-alone IP66 types)		
Conformity	IEC, CE		
Shock resistance	IEC 68, 50G		
Weight	Cable type 21g, M8 connector type 23g		
Factory default settings	Response time (Standard), Output (Light On), Timer (OFF), APC (OFF),		

Independent settings between CH1 and CH2 are possible at Threshold setting, Timer setting and Light/Dark setting. Ambient Temperature is limited up to 50°C when amplifiers are connected in parallel over 4 pcs.

Options

BEF-EB01-W190

End plate



JCN-S: M8 Straight type

JCN-S : 2 meter
JCN-5S : 5 meter
JCN-10S : 10 meter



JCN-L: M8 L-shape type

JCN-L : 2 meter
JCN-5L : 5 meter
JCN-10L : 10 meter



Amplifiers

Various Shapes for mounting

Tight Bend / High-Flex

Various Detecting Modes

Environment-resistant

Liquid

Extension lens

Notes

Circuit diagram

Stand-alone model

NPN output

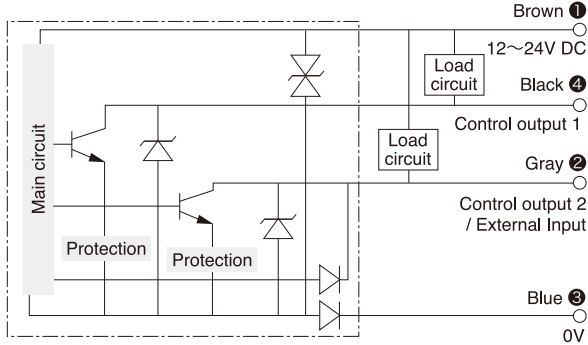

PNP output

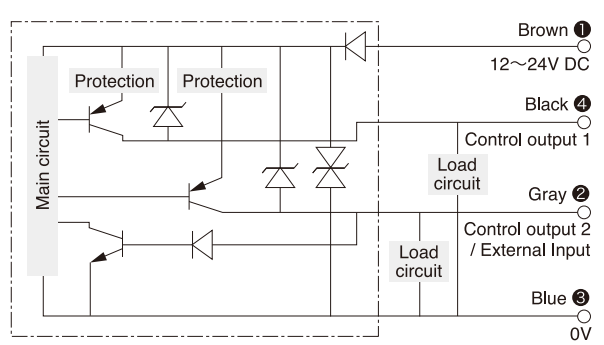

Interconnection model

NPN output

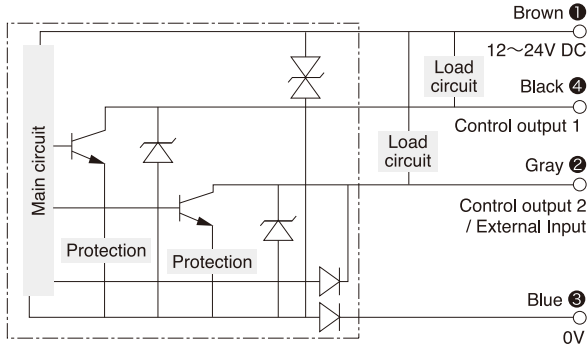

PNP output

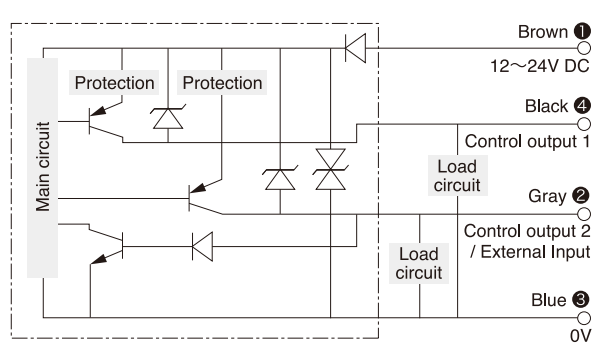

• Power wires (Brown 1, Blue 3) are not attached to Handset unit, both on cable and connector type.

Analogue model

NPN output

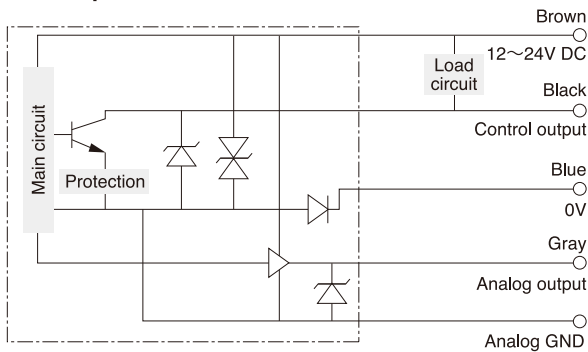

PNP output

