

6448

DC axial compact fan



ebm-papst St. Georgen GmbH & Co. KG

Hermann-Papst-Str. 1
D-78112 St. Georgen
Phone +49 (0) 7724 81-0
Fax +49 (0) 7724 81-1309
info2@de.ebmpapst.com
www.ebmpapst.com

Nominal data

Type	6448	
Nominal voltage	VDC	48
Nominal voltage range	VDC	28 .. 60
Speed	min ⁻¹	3400
Power input	W	17.0
Min. ambient temperature	°C	-20
Max. ambient temperature	°C	72
Air flow	m ³ /h	410
Sound power level	B	6.4
Sound pressure level	dB(A)	57

ml = Max. load · me = Max. efficiency · fa = Running at free air · cs = Customer specs · cu = Customer unit
Subject to alterations



Technical features

General description	Housing with earthing lug for bolt M4 x 8 (Torx) Free air power consumption, these values may be considerably higher at the operating point.
Mass	0.760 kg
Dimensions	172 x 150 x 51 mm
Material of impeller	Fibreglass-reinforced plastic (PA)
Housing material	Die-cast aluminium
Direction of air flow	Air exhaust over bars
Direction of rotation	Left, looking at rotor
Bearing	Ball bearings
Lifetime L10 at 40 °C	75000 h
Lifetime L10 at maximum temperature	35000 h
Connection line	Flat plugs 3.0 x 0.5 mm.
Motor protection	Protected against reverse polarity and locking.
Locked-rotor protection	Electronic blocking protection, with electronic motor current limit in the startup phase and when the rotor is blocked.
Approval	VDE, CSA, UL, CE
Option	Speed signal

Product drawing

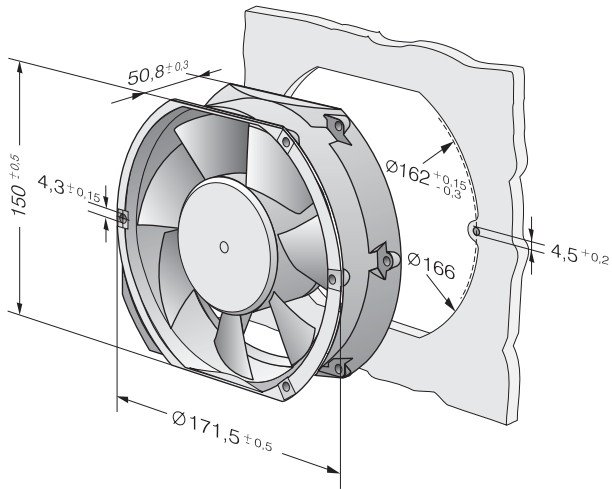

Charts: Air flow

