



HINODE
PROTECT FUSE
Product Catalog

Today's power devices are generally equipped with various security features, and their safety has improved greatly.

However, extraordinary, unexpected "accidents" do happen from time to time.

All means of protection adopted on design may become futile in cases such as:

- Errors in assembly work
 - Contamination with a foreign substance
 - Damage to semiconductors by disturbances such as heat or shock
- Before such accidents affect other chips or equipment, HINODE PROTECT FUSE will safely block off equipment as the last line of protection.

What is the HINODE PROTECT FUSE?

HINODE PROTECT FUSE is a fast-acting fuse that blocks off equipment in a few microseconds even in cases of short-circuit accidents that ordinary fuses (slow-blow fuses) and circuit breakers cannot protect against.

FEATURES OF HINODE PROTECT FUSE

- Safe and reliable: Fast-acting fuse that can block off even direct-current
- Small and compact: Compared with a slow-blow fuse and a circuit breaker (see photo)
- Applicable to high voltage: Up to 1500V*
- Large capacity: Current blocking capacity of up to 100kA*

* Specifications vary depending on the product; refer to the specifications of each product for details.

Applications of HINODE PROTECT FUSE

HINODE PROTECT FUSE is widely used for general power electric products (approximately 1kW), including:

- Inverter motor drivers
- Servo drivers
- Direct-Current power sources
- Alternating-Current variable power sources
- Uninterruptible power supplies (UPSs)
- Hybrid cars and electric vehicles

Q : Is HINODE PROTECT FUSE easy to break if it is so quick to cut off?

A : No, it's not. Conversely, around the rated amperage, our fuse is less likely to break than a slow-blow fuse (refer to chart below).

Comparison between PROTECT FUSE and a slow-blow fuse
Curve of Fusing Time vs. Current

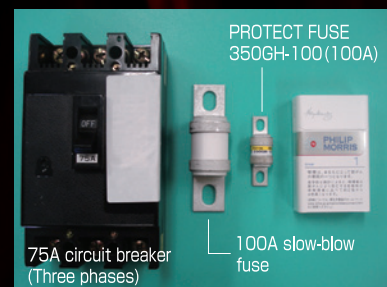
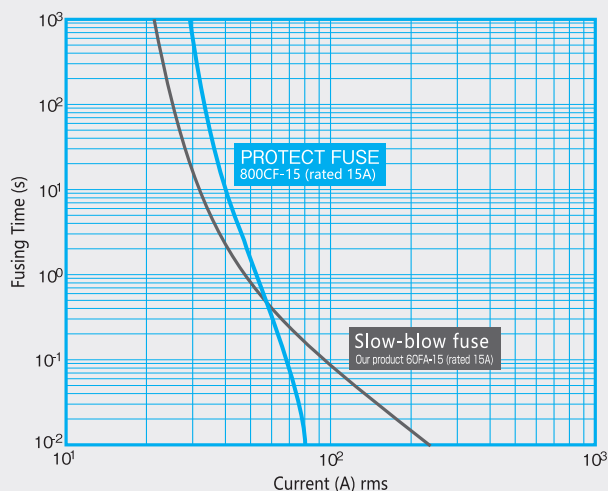

PURPOSE AND APPLICATIONS

When a short circuit occurs, an overcurrent*1 greatly exceeding the rated amperage flows in a circuit. This causes abnormal heat generation on the wiring pattern and parts and may lead to an accident such as ignition, fumes, or explosion. When a short-circuit current damages a component,

it is generally not easy to locate, so restoration of functionality tends to take a long time. Our fuses will help minimize such accidents and, in the case of an accident, will help you work efficiently for restoring the functionality*2. The following are applications of our fuses:

Protecting semiconductors (diodes, thyristors, etc.)

- Purpose: To protect semiconductors from the overcurrent when a load circuit shorts out or to prevent secondary damage when a semiconductor itself is broken down.*3
- Applications: Thyristor stacks, electric power regulators, electric furnaces (equipment with heater controls by SSR, etc.), DC stabilized power supplies, and, generally, modules with a power device.

Protection from a short circuit caused by deterioration of components

- Purpose: To prevent secondary damage from an internal short circuit caused by a decrease of insulation resistance that is the result of deterioration of a condenser.
- Applications: Capacitors and circuits using smoothing condensers (such as power supply circuits).

Protection from a short-circuit mode (arm short circuit) in an inverter circuit

- Purpose: To prevent secondary damage of an arm short circuit caused by destruction of a transistor or a diode, a breakdown of a control circuit and/or a drive circuit, or a malfunction by noise.
- Applications: Bridge circuits in equipment (motor drives, air conditioners, UPSs, etc.) with an insulated gate bipolar transistor (IGBT) or other related semiconductors.

Protection from any other short circuits such as output short circuits, earth short circuits, and battery short circuits

- Purpose: To prevent secondary damage of an output short circuit or an earth short circuit caused by miswiring, an insulation defect of a load, etc. To protect between devices or between units. To prevent secondary damage caused by a two-polar-plate short circuit of a battery.
- Applications: All industrial equipment such as battery-powered machinery (forklifts, golf carts, UPSs, etc.), control boards, instruments to manufacture semiconductors, and so on.





















*1 Short current depends on the capacity of the circuit, but it could be a large current above a few thousand amperes.

Most of our products have a current-blocking capacity of over 10kA at the maximum and are able safely to block off such current.

*2 Because of cut-off by a fuse, it is easy to locate the troubled circuit and also to minimize damage to other devices.

*3 The breakdown of semiconductors is caused by diode destruction, gate destruction, temperature destruction, avalanche destruction, oscillation destruction, and so on.

CONTENTS

Series Name	Voltage	Electric Current	Cylinder Size (Estimated)	Installation Method	Page	RoHS Order	Standard Approved ^{*4}
● COMPACT FAST ACTING FUSES							
250SF/250SFK	250V	4~25A	φ6×31	Clipped / Board Soldered	P6~7	Conforming	
500SF/500SFK	500V	4~20A	φ6×31	Clipped / Board Soldered	P6~7	Conforming	
400KH/400KHK	400V	5~60A	φ10×26	Screwed/ Board Soldered	P8~9	Conforming	
500VSK/VSH/ESK/ESH	500V	10~40A	φ6.5×24.5	Screwed/ Board Soldered	P10	Conforming	 
600KFK	600V	30A+50A	φ10×38	Board Soldered	P11	Conforming	
660CF/KH/KHK	660V	5~60A	φ10×38	Clipped / Board Soldered / Screwed/	P12~13	Conforming	
700CF/800CF/1000CF	700V / 1000V	5~40A	φ15×51~	Clipped	P14~16	Conforming	
● CYLINDRICAL FAST ACTING FUSES — SCREWING TYPES							
350GHK	350V	50~100A	φ17×22	Board Soldered	P17	Conforming	
250GH/350GH	250V/350V	16~800A	φ17×25~	Screwed	P18~20	Conforming	 
660GH	660V	16~710A	φ17×46~	Screwed	P21~22	Conforming	 
750GHK	850V	50~100A	φ17×44	Board Soldered	P23	Conforming	 
750GH	850V	50~315A	φ17×46~	Screwed	P24~25	Conforming	 
1000GH	1000V	16~630A	φ17×66~	Screwed	P26~27	Conforming	
● SQUARE FAST ACTING FUSES							
600SPF	600V	80~1750A	□30×43×53~	Screwed	P28~29	Conforming ^{**5}	
1000SPF	1000V	80~1500A	□30×43×73~	Screwed	P30~31	Conforming ^{**5}	
1500SPF	1500V	80~	□30×43×103~	Screwed	P32~33	Conforming ^{**5}	
● Options							
FUSE HOLDERS					P34~36	Conforming	
MICROSWITCHES					P35	Conforming	

*4 It does not mean that the standard approved applies to every rated voltage. Refer to the product information page of each fuse for details.

*5 Not conforming to Chinese RoHS.

The information for products not listed in this catalog can be found on our website.

QUESTIONS AND ANSWERS

I'd like to know which fuse to use.

Refer to page 48 of PROTECT FUSE USER'S GUIDE. Fuses need to have two opposing functions: blocking performance (the lower the rated amperage against conduction current, the better) and durability (the higher the rated amperage against conduction current, the better). Select a fuse that strikes a good balance between those two according to your needs.

What should I do when all fuses seem to be unsuitable?

Do not hesitate to contact our office. The data of each fuse and the guidelines on how to choose them listed in this catalog have margins for simplification. We are ready to provide you with more detailed information. Also, if you could provide us with details of your situation, we would be delighted to help you determine the best product for your needs.

I'd like to know the withstand voltage performance.

Refer to each rated voltage shown on the product pages. Select a fuse with a larger rated frequency than the circuit voltage (for DC, voltage after rectification) on the short circuit expected in case of an accident. Take the following points into consideration:

- Keep in mind that rated voltage of a fuse differs between AC and DC.
- For DC, available voltage changes according to the time constant (L/R) on the short circuit. Refer to the chart titled "Application to direct-current circuit" on each product page.
- Depending on the standard observed (UL standard, CCC standard, etc.), the rated voltage may change. Be aware that the fuse may not be regarded as an approved fuse when used in a circuit exceeding the rated voltage.
- Block-off can be achieved with a fuse that you select by following the above instructions. However, adopting a fuse with more voltage as leeway will enable you to:
 - Cope with voltage fluctuation.
 - Shorten the block-off time (mentioned below).
 - Decrease the minimum block-off current.

I'd like to know the blocking performance.

- I'd like to know if the fuse can block off before the object under protection is damaged.
 - a) If overcurrent time is approximately over 10ms
 - (A) Refer to the fusing characteristics curve. If the current (A) vs. time (s) curve of the fracture characteristics of the target object is positioned to the right of the fusing characteristics curve of the product, it means the fuse can block off before the object is damaged.
 - b) If overcurrent time is approximately under 1ms
 - (A) Compensate the shutdown I^2t value of each fuse using "shutdown I^2t against the working voltage" chart.
 - (B) If the permissible I^2t value for the target object is available, compare the shutdown I^2t with it, and if the shutdown I^2t is smaller than the permissible I^2t value, it means the fuse can block off before the object is damaged.
 - (C) If only the damaging current vs. time curve of the target object is available, calculate its permissible I^2t value [= (damaging current)² × time] and compare in the same way as in (B).
- For the area of (A), it appears to be protected by other protection equipment and/or current-limiting functions, and our fuses are often selected emphasizing protecting the area of (B). Also, even in cases that the shutdown I^2t is larger than permissible I^2t , our fuses are often used to prevent explosions, ignitions, and secondary damage.

- I'd like to know the current value that the fuse cannot block off.
 - Refer to the blocking capacity of each fuse. Electric current exceeding the value cannot be blocked off.
 - Refer to the minimum block-off current of each fuse. Electric current below this value cannot be blocked off. Despite fusing, block-off may not take place, possibly causing an accident. Therefore, take the following measures:
 - ◆ Using the current control function of the circuits of other protection devices, ensure that current does not flow in that area.
 - ◆ Use a fuse with a rated voltage above the circuit voltage to reduce the minimum block-off current.

I'd like to know the electric durability performance.

- I'd like to know the maximum magnitude (amperes) and the maximum rate of increase of overcurrent that a fuse can endure.
 - Read the value from the fusing characteristics curve of each fuse.
 - When an electric current larger than current range of a fusing characteristics curve flows, the value is calculated from the fusing I^2t value of each fuse.
[Fusing time = fusing I^2t value ÷ (short-circuit current value)²]
(The fusing time and electric current are effective for overcurrent only once. Once such an overcurrent flows, the fuse becomes easy to cut off. For more details, refer to the material about life expectancy).
- I'd like to know the life expectancy of the fuse against constant electric current and repetitive overcurrent.
→ Refer to separate materials for details.

I'd like to know an environmental resistance performance.

- Heat generation: Refer to the temperature characteristics chart of each fuse.
- Temperature characteristics: Refer to the chart titled "Compensation by ambient temperature."
- Other details on environmental resistance: Contact us for more information.
(Additional environmental testing may be required for in-vehicle fuses.)

I'd like to purchase a PROTECT FUSE.

Consult your agent or our company directly any time. If you already know which fuse to purchase, request an estimate using the request form at the back of this catalog. You can also ask for an estimate from our website (<http://www.hinodedenki.co.jp/>).

I'd like to ask for analysis of a cut-off fuse.

Consult your agent or our company any time.

*Characteristics of each fuse (fusing characteristics, I^2t value, etc.) indicated in this catalog are average values and may change according to its condition of use, its environmental condition, individual variability, and so on. Use sufficient margin when making a selection.

HOW TO USE THIS CATALOG

600SPF
SQUARE FAST ACTING FUSES

FEATURES

- Large capacity: 1750A
- On-time type capable of being connected with copper bars
- Standard model equipped with function to indicate fusing
- Block-off time can be reduced (optional)

CAUTION

At Back: PROTECT FUSE USER'S GUIDE and "FOR SAFE USE" at the back of this catalog before use.

At the minimum working voltage of the fusing indication function is 100V.

Standard Model	Type	Rated Voltage (V rms)	Rated Amperage (A)	Fusing Characteristics		Block-off Time (s)	Temperature Rise (°C)	Power Loss (W)	Shutdown I²t (A²s)	Application to Direct-current Circuit
				I²t (A²s)	I²t (A²s)					
600SPF100A	100	100	100	100	100	100	100	100	100	100
600SPF125A	125	125	125	125	125	125	125	125	125	125
600SPF150A	150	150	150	150	150	150	150	150	150	150
600SPF200A	200	200	200	200	200	200	200	200	200	200
600SPF250A	250	250	250	250	250	250	250	250	250	250
600SPF300A	300	300	300	300	300	300	300	300	300	300
600SPF350A	350	350	350	350	350	350	350	350	350	350
600SPF400A	400	400	400	400	400	400	400	400	400	400
600SPF450A	450	450	450	450	450	450	450	450	450	450
600SPF500A	500	500	500	500	500	500	500	500	500	500
600SPF600A	600	600	600	600	600	600	600	600	600	600
600SPF700A	700	700	700	700	700	700	700	700	700	700
600SPF800A	800	800	800	800	800	800	800	800	800	800
600SPF900A	900	900	900	900	900	900	900	900	900	900
600SPF1000A	1000	1000	1000	1000	1000	1000	1000	1000	1000	1000
600SPF1250A	1250	1250	1250	1250	1250	1250	1250	1250	1250	1250
600SPF1500A	1500	1500	1500	1500	1500	1500	1500	1500	1500	1500
600SPF1750A	1750	1750	1750	1750	1750	1750	1750	1750	1750	1750

Product name example: **350GH - 125SUL**

- UL: UL-approved product
- TC: CCC-approved product
- S: Fuse with sound alarm
- None: Fuse without sound alarm
- Rated amperage
- Series name: 2 letters plus "-" (hyphen) or 3 letters
- Rated voltage

- 1 DC rated voltage**
The fuse can be used in a direct-current circuit with voltage under this value.
- 2 Time constant (L/R)**
The fuse for the circuit over this value of the closed path time constant, which is assumed when a short circuit occurs. (Refer to the chart titled "Application to direct-current circuit" for details.)
*Under some conditions, the fuse may not be used even at a value lower than this.
- 3 Current-blocking capacity**
The fuse can block off a short-circuit current up to this value.
- 4 AC rated voltage**
The fuse can be used at an AC rated voltage under this value.
- 5 Minimum block-off current**
The fuse may not be able to block off when it fuses at a value lower than this overcurrent (refer to the fusing characteristics chart); therefore, it is necessary to block off using the current-limiting function of chips. If you choose a fuse with sufficient margin in rated voltage, the minimum block-off current can be reduced.
- 6 Maximum arc voltage**
Depending on the situation, there might be a difference of electric potential between both terminals up to this value at the moment of fusing. It is important to pay attention to the arrangement of the peripheral parts.

- 7 Rated amperage**
The rated amperage value is prescribed in JEM1383. Derating is necessary for normal current. (Refer to PROTECT FUSE USER'S GUIDE.)
- 8 Fusing I²t**
The Joule-integral value against the fusing time (refer to Q&A section below). This value is used in case of overcurrent, which is rather short (approximately 1ms or less) and large (tens of times the rated amperage). It is possible to determine the fusing time and fusing current from this value.
- 9 Shutdown I²t**
The Joule-integral value against the shutdown time (refer to Q&A section below). This value is used to consider the protection performance in case of overcurrent, which is rather short (approximately 1ms or less) and rather large (tens of times the rated amperage). This value needs to be smaller than the permissible I²t of the chip for perfect protection of a semiconductor.

- 10 Fusing characteristics chart**
This chart shows the time (in seconds) the fuse takes for fusing the overcurrent at each level of amperage. This chart shows an average value. This value is used in case of an overcurrent that is long (10ms or more) and small (from several times to tens of times the rated amperage). Because the arc time is short enough compared to the fusing time for electric current in this area, the fusing time can be regarded as the same as the block-off time.
- 11 Current-limiting characteristics chart**
When a short circuit occurs, the peak value of the short-circuit current will be from $\sqrt{2} \times I_p$ to $2.5 I_p$ (I_p : effective value of the short-circuit current) for alternating current, but the fuse will restrain the current before reaching this value. This chart shows the peak value of the restrained current. When protecting a semiconductor such as a thyristor completely, it is necessary to choose a fuse with a smaller value than the surge on-state current rating of the chip.
- 12 Temperature-rise chart**
The temperature-rise value around the center of the fuse in the test environment prescribed in JEM1383. (Only for board-soldered-type fuses, refer to each product page for testing conditions.)
- 13 Power loss chart**
When a working current is below the rated amperage, use both this chart and the specification table to obtain a power loss value. [Power loss = power loss at the time of rated amperage (refer to the specification table) × coefficient α (refer to this chart)]
- 14 Shutdown I²t against the working voltage chart**
This chart shows that the block-off time can be reduced (the shutdown I²t can be smaller) by using the voltage that has sufficient margin against the rated voltage of the fuse. [The shutdown I²t at the working voltage = the shutdown I²t (refer to the specification table) coefficient β]
- 15 Application to direct-current circuit chart**
When using the fuse for a direct-current circuit, you must be aware that if the time constant (L/R) on the assumed limiting short-circuit current exceeds the value on this chart, the fuse cannot block off properly.

Q. What is the difference between fusing and blocking off?

A. When an overcurrent flows, the soluble form in the fuse is dissolved by Joule heat (this process is called "fusing"). However, at the moment of fusing, arc discharge occurs around the cut-off area and it remains electrically connected. The electrically disconnected state seen when this discharge ends is called "blocked off" or "shutdown." For our products, values regarding fusing are used mainly to consider the life expectancy, and values regarding blocking off are mainly used to consider the protection performance.

250SF/250SFK, 500SF/500SFK

FEATURES

- A 6-mm- ϕ fuse, which is the same size as a glass tube fuse, can be used to implement a current blocking capacity of 10kA at 500V
- Able to block off even DC
- Space-efficient
- UL approved for up to rated 20A (500SF/SFK)

RATING

● 250SF/SFK

Rated voltage and blocking capacity : 250V AC-10kA, 250V DC (L/R = 10ms)-10kA
 Minimum block-off current : 250V AC/DC- 4 times the rated amperage
 Maximum arc voltage: 500V

● 500SF/SFK

Rated voltage and blocking capacity : 500V AC-10kA, 500V DC (L/R = 2ms)-10kA
 Minimum block-off current : 500V AC/DC- 4 times the rated amperage
 Maximum arc voltage : 1000V

UL / cUL standard approved rating

Rated voltage and blocking capacity: Same as the standard rating.
 (250SF/SFK are not cUL approved.)

Specifications 250SF/250SFK

Ta= 25°C

Type	Rated Amperage (A)	Fusing I ² t (A ² S)	Shutdown I ² t (A ² S) at AC250V 10KA	Power Loss (W)	Weight (g)	Fig	Standard
250SF-4UL	4	4	14	0.6	2.5	SF= Fig 1	UL
250SFK04UL				0.7			
250SF-6UL	6	11	27	0.9	3.25	SFK= Fig 2	
250SFK06UL				1.1			
250SF-10UL	10	25	60	1.6	3.25	SFK= Fig 2	
250SFK10UL				1.7			
250SF-16UL	16	55	120	3.5	3.25	SFK= Fig 2	
250SFK16UL				3.2			
250SF-25	25	220	400	5.0	3.25	SFK= Fig 2	
250SFK25				5.0			

500SF/500SFK

Ta=25°C

Type	Rated Amperage (A)	Fusing I ² t (A ² S)	Shutdown I ² t (A ² S) at AC500V 10KA	Power Loss (W)	Weight (g)	Fig	Standard
250SF-4UL	4	4	29	0.6	2.5	SF= Fig 1	UL
				0.7			
500SF-6UL	6	11	50	0.9	3.25	SFK= Fig 2	
500SFK06UL				1.1			
500SF-10UL	10	25	110	1.6	3.25	SFK= Fig 2	
500SFK10UL				1.7			
500SF-16UL	16	55	230	3.5	3.25	SFK= Fig 2	
500SFK16UL				3.2			
500SF-20UL	20	155	480	4.0	3.25	SFK= Fig 2	
500SFK20UL				4.3			

Dimensions 250SF, 500SF (Fig.1)

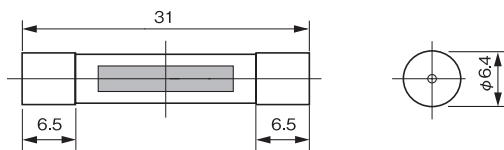

250SFK, 500SFK (Fig.2)

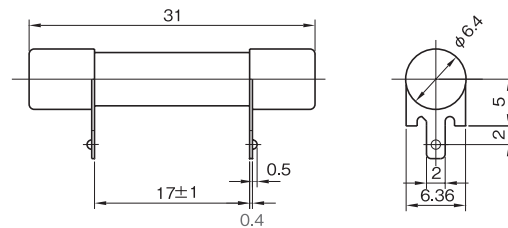

Fusing Characteristics 250SF/250SFK

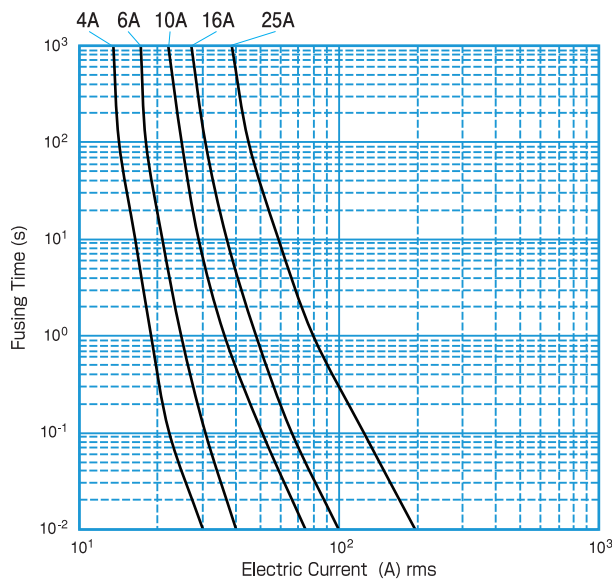

500SF/500SFK

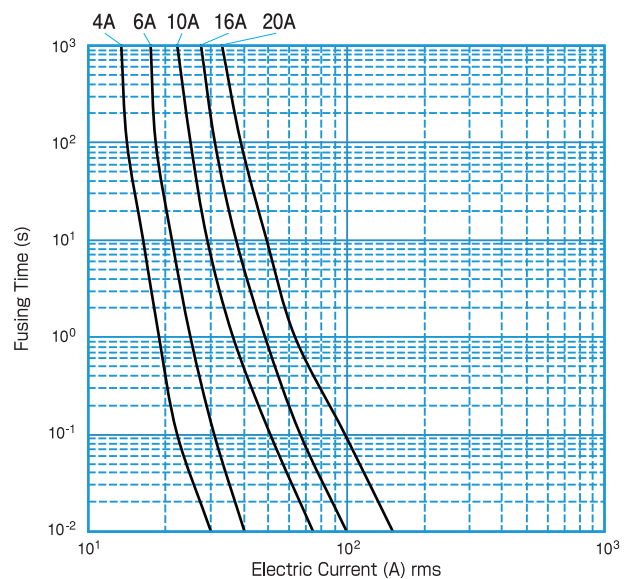

FAST ACTING FUSES - COMPACT TYPES

Temperature Rise 250SF/500SF

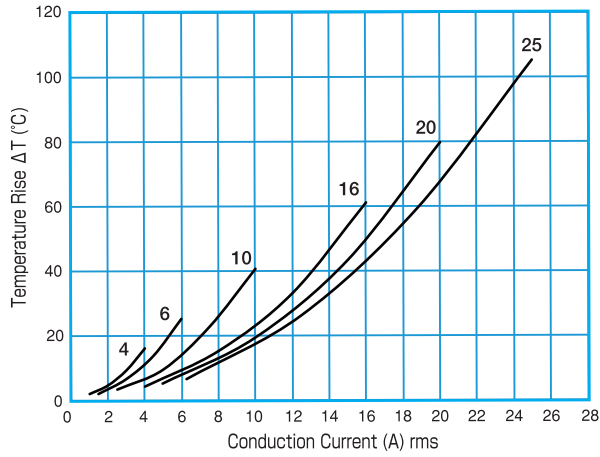

250SF K /500SF K

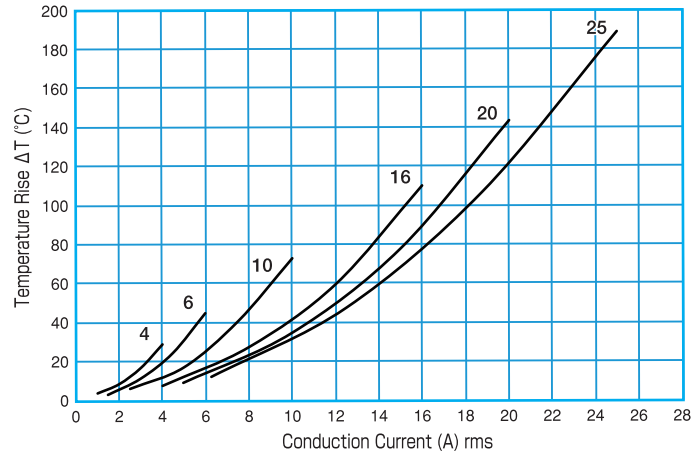

Power Loss 250SF/500SF

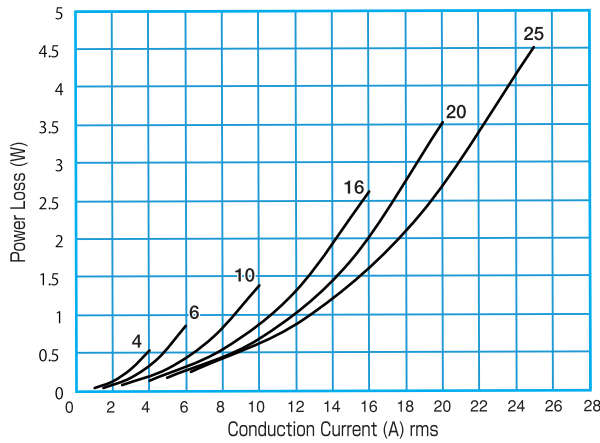

250SF K /500SF K

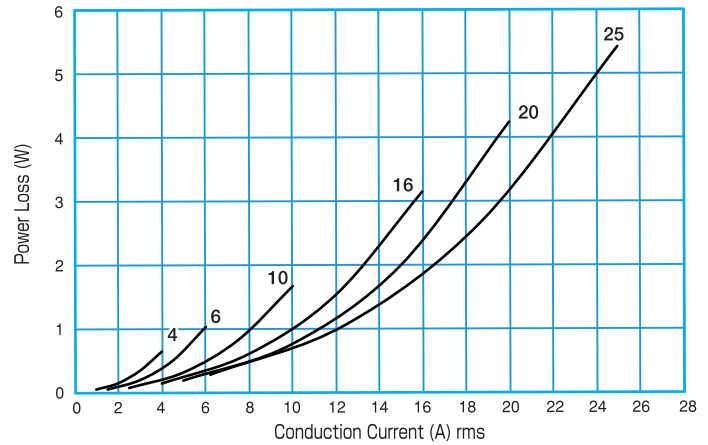

Shutdown I^2t Against Working AC Voltage

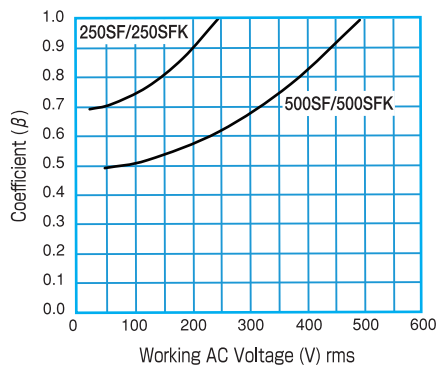

Current-Limiting Characteristics

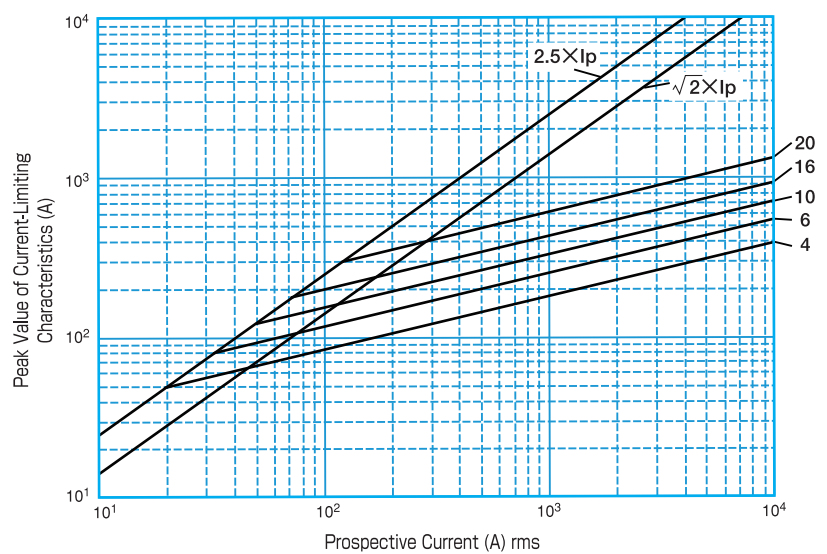

Application to Direct-Current Circuit

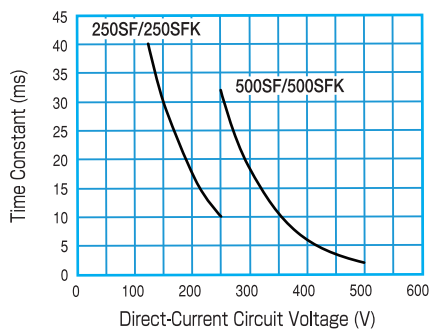

Power Loss and Temperature Characteristics

● Testing Conditions for Board-Soldered-Type Fuses

The power loss and the temperature characteristics are studied using an FR-4 board (one-side board) and a 35- μ m-thick copper foil with a copper foil width of 0.5 mm/A depending on the rated amperage (e.g. 5 mm width for a product rated at 10A).

400KH/400KHK

FEATURES

- The full length is 26 mm (KHK), which is convenient to arrange on the board.
- Being extremely compact, it is compliant to 400V-50A class.
- Contribute to miniaturizing the equipment.
- Most suitable for small inverters, servos, UPSs, power supplies, etc.
- Two types are available for choice according to the installation method.

RATING

●Rating 5-30A

Rated voltage and blocking capacity : 400V AC - 10kA, 400V DC (L/R = 5ms)-10kA
 Minimum block-off current : 400V AC/DC - 4 times the rated amperage
 Maximum arc voltage : 800V

●Rating 35-60A

Rated voltage and blocking capacity : 400V AC-10kA, 400V DC (L/R = 2ms)-10kA
 Minimum block-off current : 400V AC - 5.3 times the rated amperage
 400V DC - 20 times the rated amperage
 360V DC - 8 times the rated amperage
 Maximum arc voltage : 800V

UL standard approved rating

When applying the standard to UL standard approved items, use the fuse in the following rating.

●Rating 5-30A

Rated voltage and blocking capacity : Same as the standard rating

Specifications

Type	Rated Amperage (A)	Fusing I ² t (A ² S)	Shutdown I ² t (A ² S) at AC400V 10kA	Power Loss (W)	Weight (g)	Fig	Standard Approved			
400KH-5UL	5	2	30	0.5	KH=10.5	KH=Fig 1	UL			
400KHK05UL				0.5						
400KH-10UL	10	6	70	1.0						
400KHK10UL				1.1						
400KH-15UL	15	12	130	1.6						
400KHK15UL				1.7						
400KH-20UL	20	25	280	2.3						
400KHK20UL				2.9						
400KH-25UL	25	43	420	2.8				KHK=8.5	KHK=Fig 2	UL
400KHK25UL				2.9						
400KH-30UL	30	67	700	2.8						
400KHK30UL				3.9						
400KH-35UL	35	99	1000	2.8						
400KHK35UL				5.2						
400KH-40UL	40	177	1600	3.3						
400KHK40UL				5.2						
400KH-50UL	50	264	2100	4.5						
400KHK50UL				6.9						
400KH-60UL	60	314	2300	5.4						
400KHK60UL				7.1						



400KH



400KHK

●Rating 35-60A

Rated voltage and blocking capacity : 400V AC-10kA
 360V DC (L/R = 2ms)-10kA

CCC standard approved rating

When applying the standard to UL standard approved items, use the fuse in the following rating.

*The CCC standard is an option. Enter "TC" at the end of product name when ordering (e.g. 400KH-10ULTC).

Rated voltage and breaking capacity : 400V AC-50kA, 260V DC (L/R = 10ms)-50kA

CAUTION!

- Read "FOR SAFE USE" and "PROTECT FUSE USER'S GUIDE" at the back of this catalog before use.
- A small fuse may generate a relatively large amount of heat, so a fuse with sufficient capacity is recommended for long, continuous use.
- Fusing indication function is not provided.

Dimensions

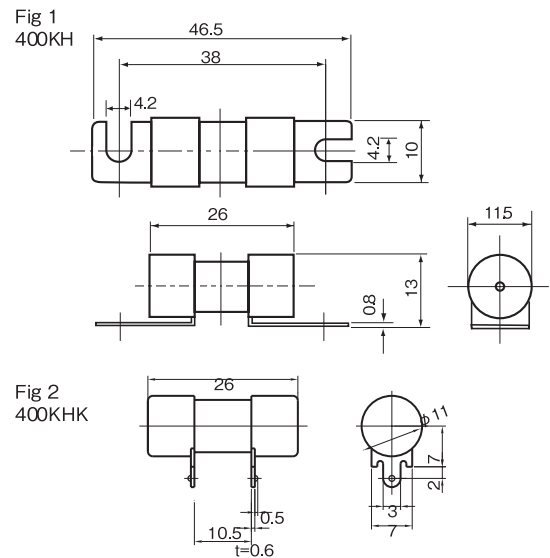

Fusing Characteristics

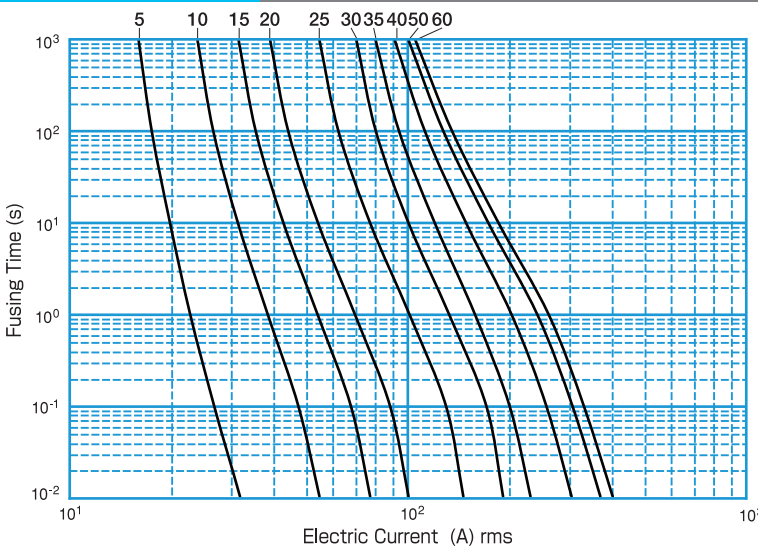

Current-Limiting Characteristics

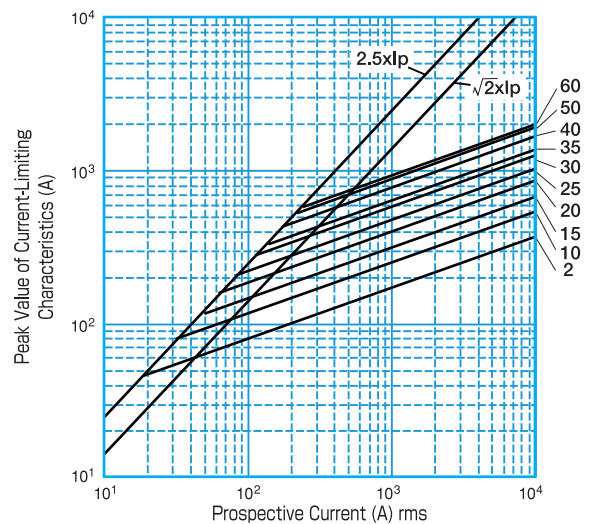

FAST ACTING FUSES - COMPACT TYPES

Temperature Rise 400KH

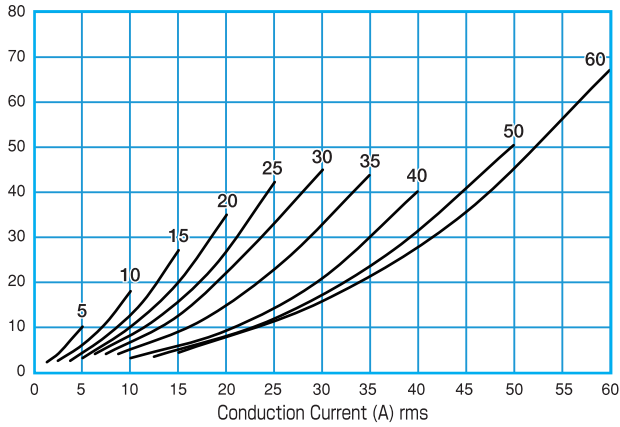

400KHK

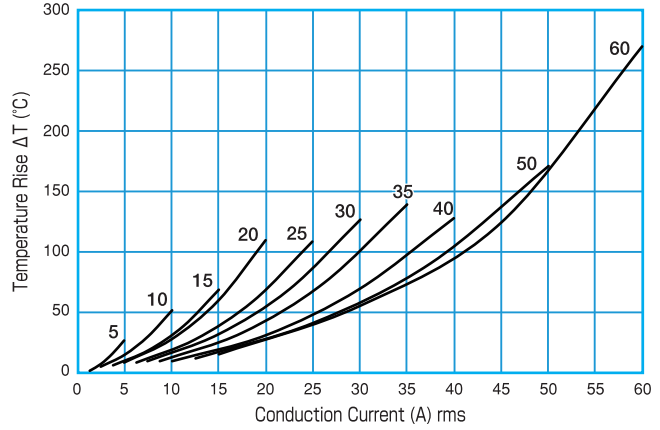

Power Loss 400KH

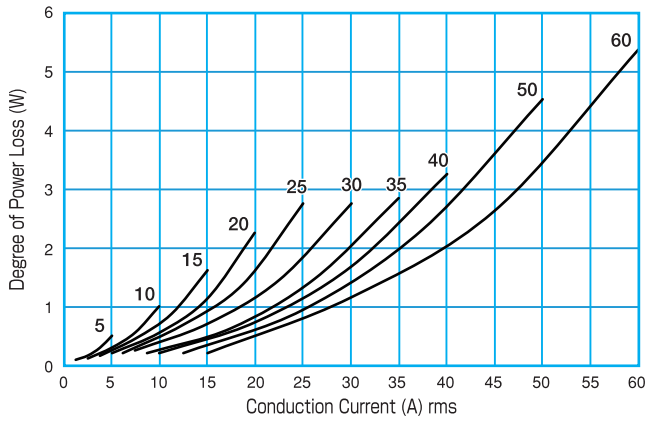

400KHK

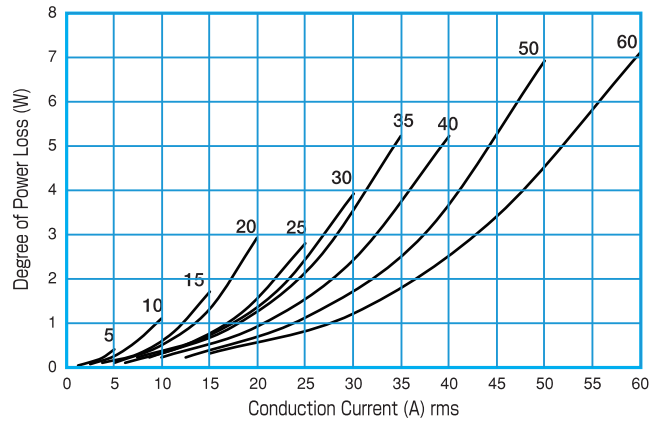

Shutdown I^2t Against Working AC Voltage

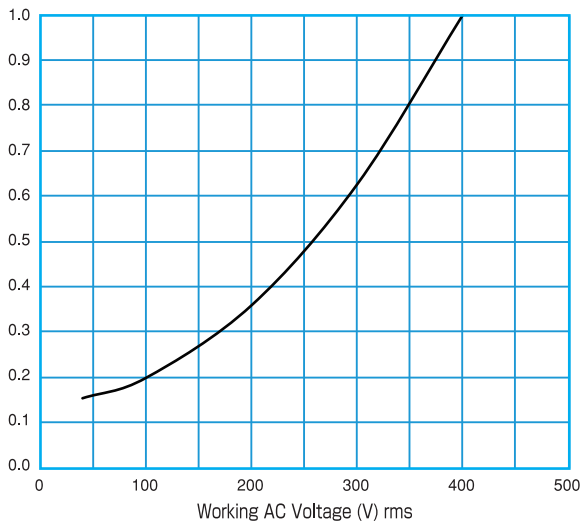

Application to Direct-Current Circuit

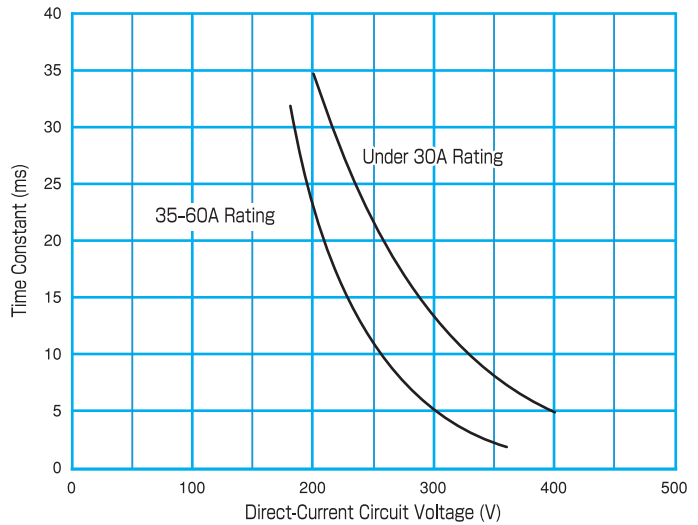

Power Loss and Temperature Characteristics

● Testing Conditions for Board-Soldered-Type Fuses

The power loss and the temperature characteristics are studied using an FR-4 board (one-side board) and a 35- μ m-thick copper foil with a copper foil width of 0.5 mm/A depending on the rated amperage (e.g., 5 mm width for a product rated at 10A).

500VSK / VSH / ESK / ESH

FEATURES

Compact size enables smaller printed board use for servo, power conditioners and inverters.

Power semiconductor breakage may lead to a circuit burnout with fuses that cut-off slowly.

This fuse is

- Fast acting and durable
- Useable with both AC and DC
- Compact body size with $\Phi 6.6 \times 25\text{mm}$ at 500V-40A rating

RATING

Rated voltage and blocking capacity: AC450V-10kA
 DC500V-1kA(Resistance circuit)
 DC450V-10kA(L/R=1ms)

Minimum block-off current : 2 times the rated amperage.
 (conditions:DC450V L/R=0.1ms)

< ESK / ESH > ※ 1 ※ 2

Rated voltage and blocking capacity : DC500V-1kA(Resistance circuit)
 DC450V-10kA(L/R=1ms)

Minimum block-off current : 5 times the rated amperage.



500VSH/ESH

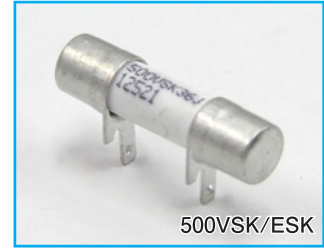

500VSK/ESK

※ 1 VSK·ESK: Board soldered type, VSH·ESH: Screwed type

UL / cUL standard approved rating

Rated voltage and blocking capacity: AC/DC 450V

CCC standard approved rating

Rated voltage and blocking capacity: AC400V DC350V

CAUTION!

- Read "FOR SAFE USE" and "PROTECT FUSE USER'S GUIDE" at the back of this catalog before use.

Specifications

Type	Rated Amperage (A)	Fusing I ² t (A ² s)	Shutdown I ² t (A ² s)	Power Loss (W)	Weight (g)	Standard Approved
500VSH10 500VSK10	10	49	110	1.0	<VSH/ESH> 3.9 <VSK/ESK> 2.7	
500VSH20 500VSK20	20	125	280	4.5		
500VSH36 500VSK36	36	400	900	10.0		
500ESH40 500ESK40	40	1380	3000	6.0		

Dimensions

Fig 1
500VSH/ESH

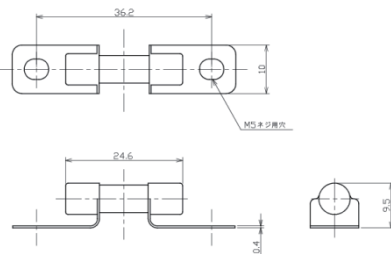
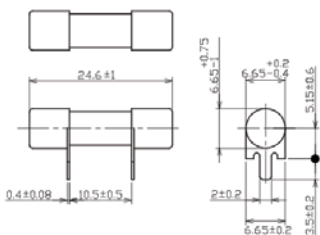
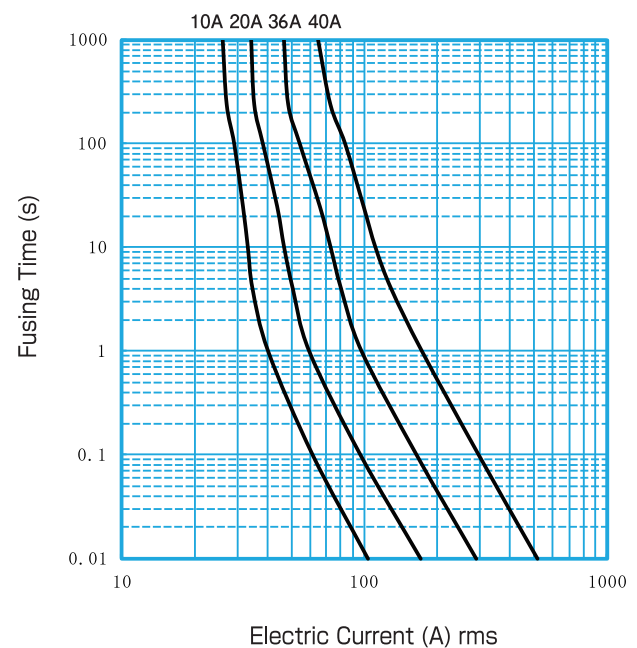

Fig 2
500VSK/ESK



Fusing Characteristics



600KFK

FEATURES

- Maintain fast acting performance and durability against inrush currents
- Compact size with $\Phi 10$
- Board mount type fuse
Suitable for use in power conditioners with storage batteries

RATING

Rated voltage and blocking capacity: AC600V DC500V

AC600V-10kA DC500V-10kA(L/R=1ms)

Minimum block-off current : AC600V,DC500V(L/R=2ms) 6 times the rated amperage.

AC400V,DC400V(L/R=2ms),

DC450V(L/R=0.5ms) 2 times the rated amperage.



600KFK

CAUTION!

- Read "FOR SAFE USE" and "PROTECT FUSE USER'S GUIDE" at the back of this
- Arc re-ignition may occur if the fusing current is less than 4 times larger than the fuse.
- Fuse should be used less than 50% of their rated current.
- The power loss and the temperature characteristics are studied using an FR-4 board (one-side board) and a 35- μ m-thick copper foil with a copper foil width of 2 mm/A depending on the rated amperage (e.g. 15 mm width for a product rated at 30 A).

Specifications

Type	Rated Amperage (A)	Fusing \uparrow (A \cdot s)	Shutdown I 2 t (A \cdot s)	Power Loss (W)	Weight (g)
600KFK30	30	305	1500	7.5	10.5
600KFK50	50	1220	5500	11.3	

Dimensions

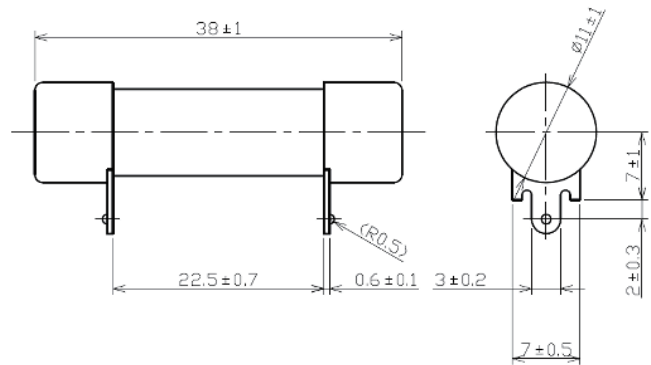

Fusing Characteristics

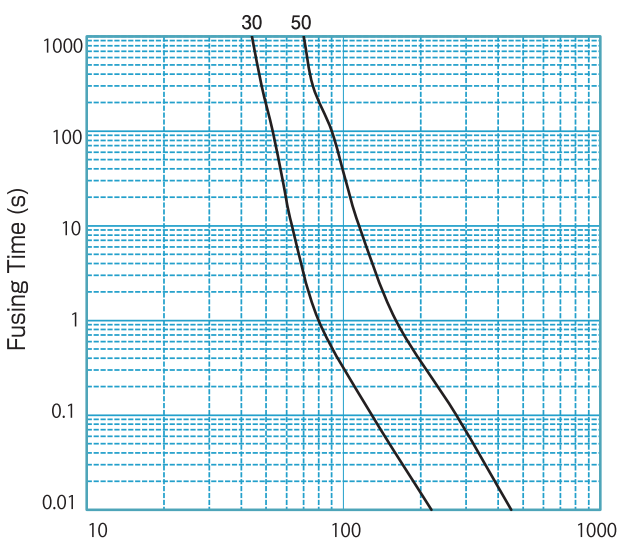

Electric Current (A) rms

Temperature Rise

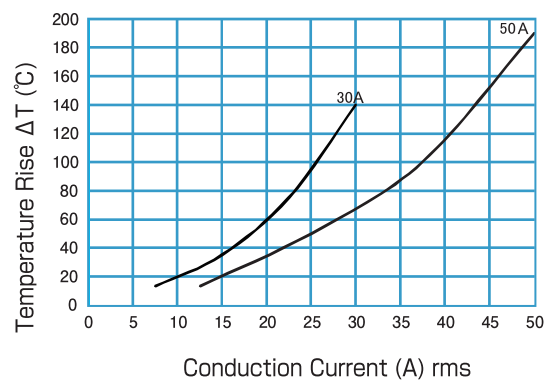

Conduction Current (A) rms

660CF/KH/KHK

FEATURES

- Three types are available for choice according to the installation method.
- Compact and light-weight, also excellent for prompt cut-off action when blocking off.
- Most suitable for small inverters, servos, UPSs, power supplies, etc.
- Compliant to all types of standards.
- A 10-mm- ϕ fuse is compliant to the 50 A class.

RATING

● Rating 5 - 60 A

Rated voltage and blocking capacity : 660V AC-10kA, 660V DC (L/R = 10ms)-10kA

Minimum block-off current : 660V AC - 6 times the rated amperage

660V DC - 20 times the rated amperage

570V DC - 8 times the rated amperage

Maximum arc voltage : 1320V

CAUTION!

- Read "FOR SAFE USE" and "PROTECT FUSE USER'S GUIDE" at the back of this catalog before use.
- A small fuse may generate a relatively large amount of heat, so a fuse with sufficient capacity is recommended for long, continuous use.
- Fusing indication function is not provided.



660CF



660CF/KH/KHK



660KH



660KHK

UL/cUL standard approved rating

When applying the standard to UL standard approved items, use the fuse in the following rating.

● Rating 5 - 30 A

Rated voltage and blocking capacity : Same as the standard rating

● Rating 35 - 60 A

Rated voltage and blocking capacity : 660V AC-10kA, 570V DC (L/R=2ms)-10kA (660KH/KHK are not cUL approved.)

CCC standard approved rating

When applying the standard to CCC standard approved items, use the fuse in the following rating.

*The CCC standard is an option. Enter "TC" at the end of product name when ordering (e.g. 660KH-30ULTC).

Rated voltage and blocking capacity : 660V AC-10kA, 450V DC (L/R = 10ms)-10kA

Specifications

Type	Rated Amperage (A)	Fusing I ² t (A ² S)	Shutdown I ² t (A ² S) at AC660V 10kA	Power Loss (W)	Weight (g)	Fig	Standard Approved
660CF-5UL 660KH-5UL 660KHK05UL	5	2	18	0.8	CF= 8.5	CF= Fig 1	
660CF-10UL 660KH-10UL 660KHK10UL	10	6	55	1.3			
660CF-15UL 660KH-15UL 660KHK15UL	15	12	110	3.0	KH= 12.5	KH= Fig 2	
660CF-20UL 660KH-20UL 660KHK20UL	20	25	210	4.5			
660CF-25UL 660KH-25UL 660KHK25UL	25	43	340	5.0	KHK= 10.5	KHK= Fig 3	
660CF-30UL 660KH-30UL 660KHK30UL	30	67	500	5.5			
660CF-35UL 660KH-35UL 660KHK35UL	35	99	730	5.1	KH= 12.5	KH= Fig 2	
660CF-40UL 660KH-40UL 660KHK40UL	40	177	1300	5.3			
660CF-50UL 660KH-50UL 660KHK50UL	50	264	1950	7.4	KHK= 10.5	KHK= Fig 3	
660CF-60UL 660KH-60UL 660KHK60UL	60	314	2300	9.8			
				16.5			

Dimensions

Fig 1
660CF

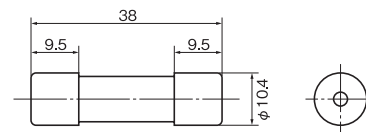

Fuse Holder HK1038

(for 660CF) refer to p. 34

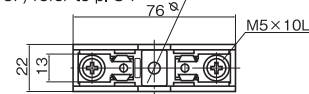

Fig 2
660KH

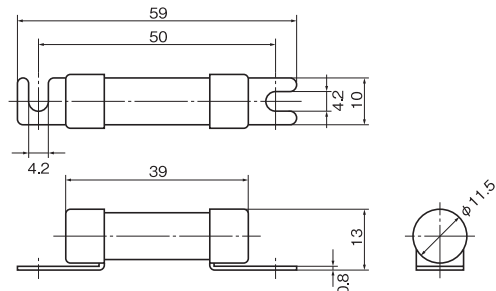
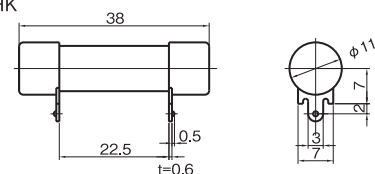
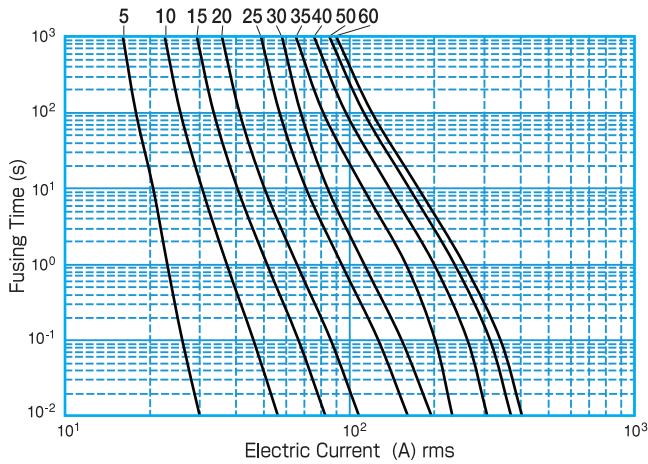

Fig 3
660KHK



Fusing Characteristics



Current-Limiting Characteristics

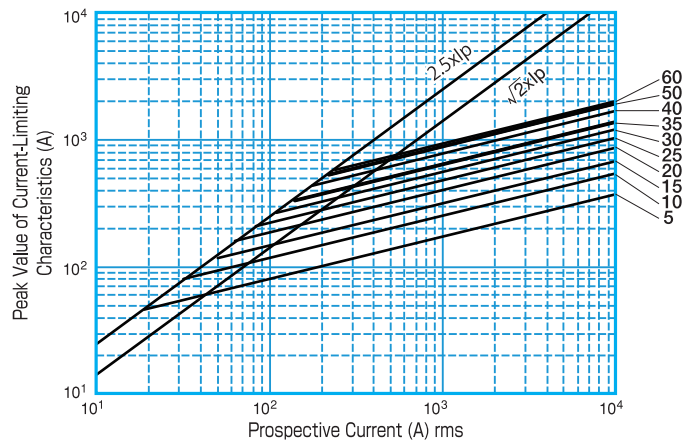

Temperature Rise

CF

KH

KHK

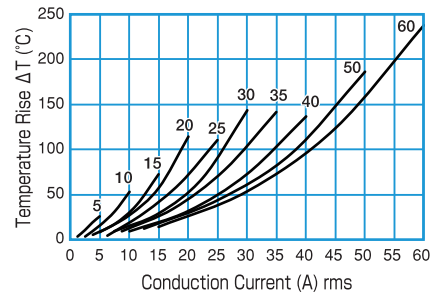
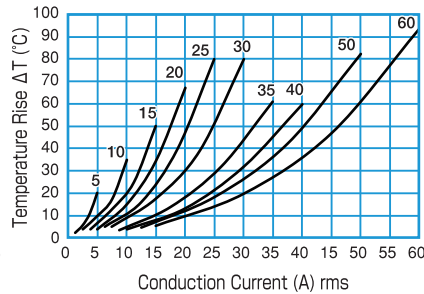
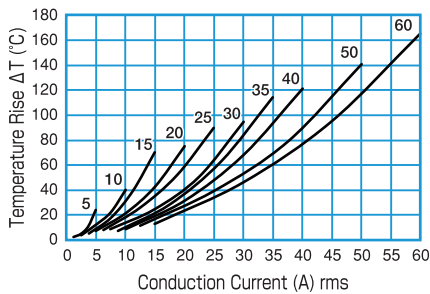

Power Loss

CF

KH

KHK

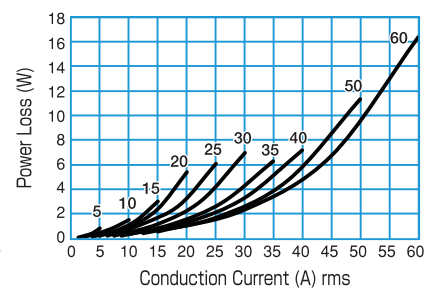
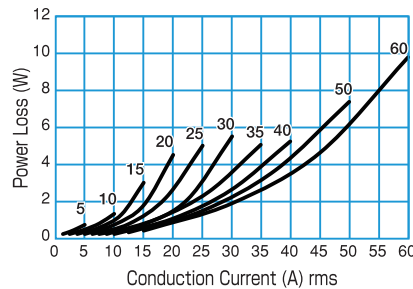
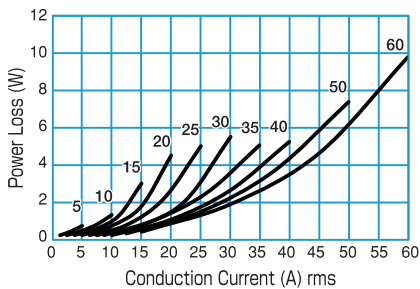

Shutdown I²t Against Working AC Voltage

Application to Direct-Current Circuit

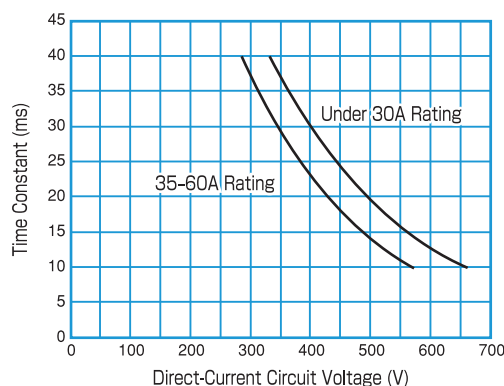
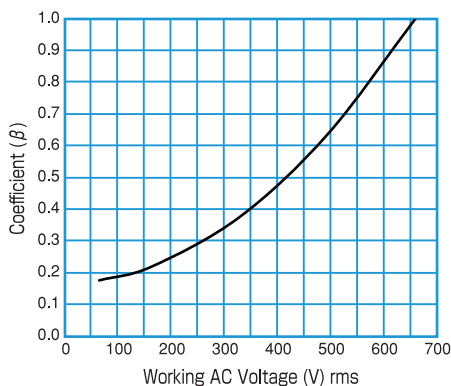

Power Loss and Temperature Characteristics

● Testing Conditions for Board-Soldered-Type Fuses

The power loss and the temperature characteristics are studied using an FR-4 board (one-side board) and a 35- μ m-thick copper foil with a copper foil width of 0.5 mm/A depending on the rated amperage (e.g., 5 mm width for a product rated at 10A).

700CF/800CF/1000CF

FEATURES

- 800V DC prepared for the regeneration voltage of 400V servos/inverters.
*800CF
- Designed for small-capacity power-supply lines of a high-pressure inverter.

RATING

● Rating 700CF- 35 to 40 A

Rated voltage and blocking capacity : 700V AC-100kA, 700V DC (L/R = 10ms)-100kA
 Minimum block-off current : 700V AC/DC - 4 times the rated amperage
 Maximum arc voltage : 1400V

● Rating 800CF- 5 to 30 A

Rated voltage and blocking capacity : 700V AC-100kA, 800V DC (L/R = 10ms)-10kA
 Minimum block-off current : 700V AC/800V DC - 4 times the rated amperage
 Maximum arc voltage: 1600V

● Rating 1000CF

Rated voltage and blocking capacity: 1000V AC-100kA
 Minimum block-off current: 1000V AC - 4 times the rated amperage
 Maximum arc voltage: 2000V



UL standard approved rating

When applying the standard to UL standard approved items, use the fuse in the following rating.

● 800CF

Rated voltage and blocking capacity : 660V AC -10kA
 800V DC (L/R = 10ms)-10kA

CAUTION!

- Read "FOR SAFE USE" and "PROTECT FUSE USER' S GUIDE" at the back of this catalog before use.
- A small fuse may generate a relatively large amount of heat, so a fuse with sufficient capacity is recommended for long, continuous use.
- Fusing indication function is not provided.

Specifications 700CF/ 800CF

Type	Rated Amperage (A)	Fusing I ² t (A ² S)	Shutdown I ² t (A ² S) at AC660V-10KA	Shutdown I ² t (A ² S) at AC700V-100KA	Power Loss (W)	Weight (g)	Standard Approved
800CF-5UL	5	2	28	36	1.1	24	
800CF-10UL	10	6	80	110	2.6		
800CF-15UL	15	12	160	225	3.0		
800CF-20UL	20	25	310	360	6.0		
800CF-25UL	25	43	390	650	6.5		
800CF-30UL	30	67	530	1000	7.0		
700CF-35	35	93	—	1300	7.5		
700CF-40	40	121	—	1690	7.5		

Specifications 1000CF

Ta=25°C

Type	Rated Amperage (A)	Fusing I ² t (A ² S)	Shutdown I ² t (A ² S) at AC1000V-100KA	Power Loss (W)	Weight (g)	Standard Approved
1000CF-5	5	1.2	21	2.1	28	—
1000CF-10	10	4.9	83	3.2		
1000CF-15	15	19.6	332	6.6		
1000CF-20	20	44.2	750	7.2		
1000CF-30	30	123.0	2000	7.6		
1000CF-35	35	177.1	3000	8.3		

Dimensions 700CF/ 800CF

1000CF

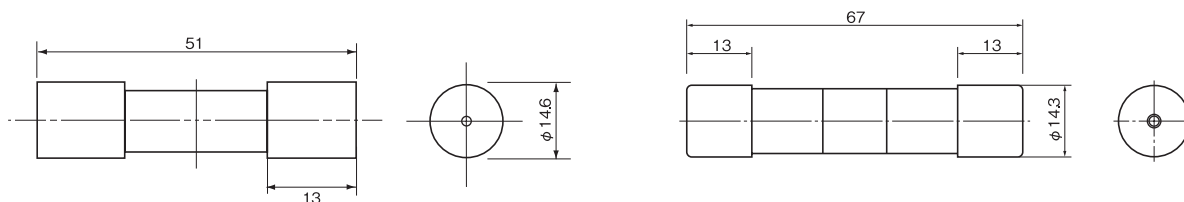

700CF/800CF

Fusing Characteristics

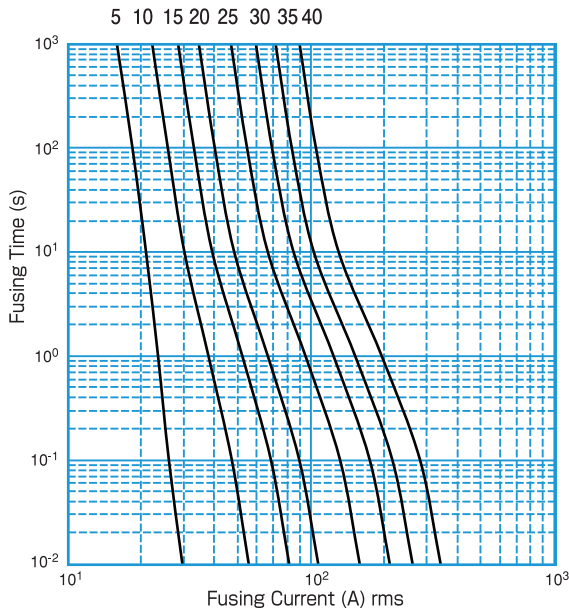

Current-Limiting Characteristics

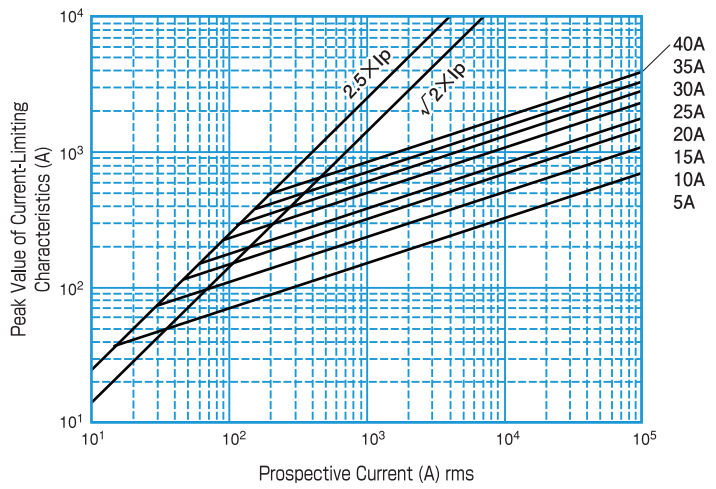

Temperature Rise

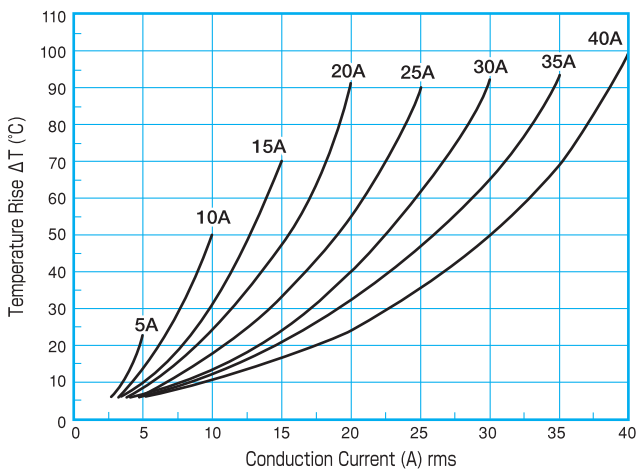

Power Loss

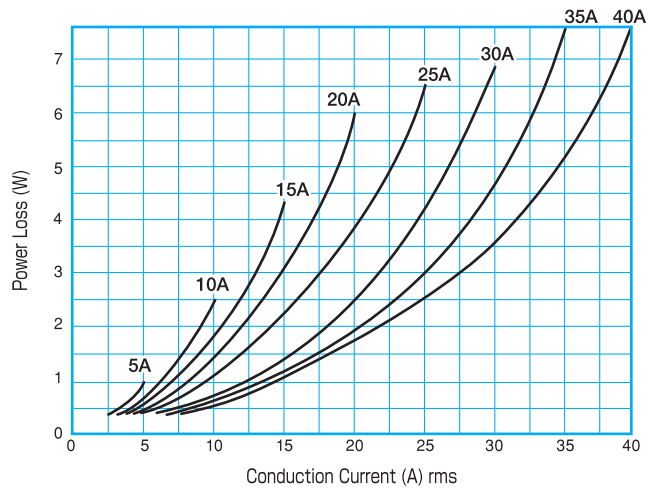

Shutdown I^2t Against Working AC Voltage

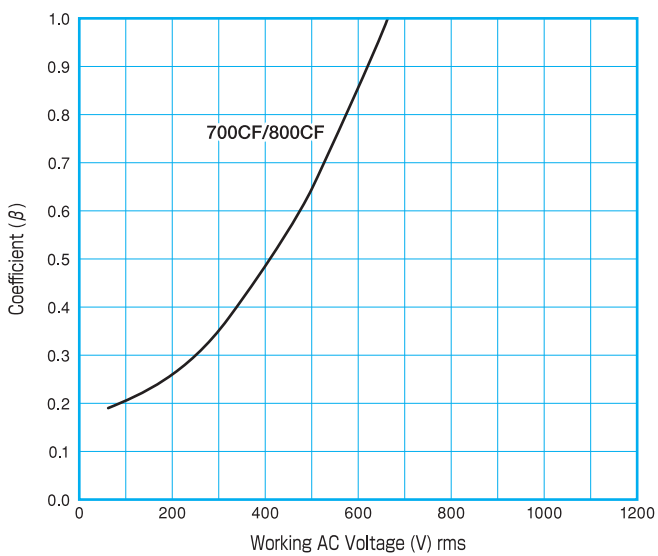

Application to Direct-Current Circuit

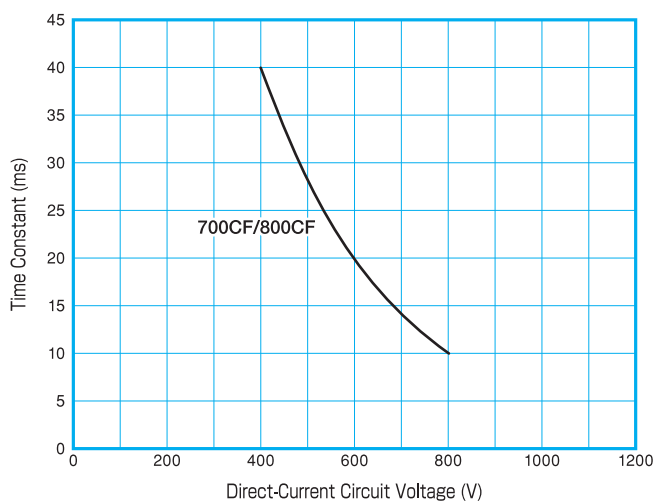

1000CF

Fusing Characteristics

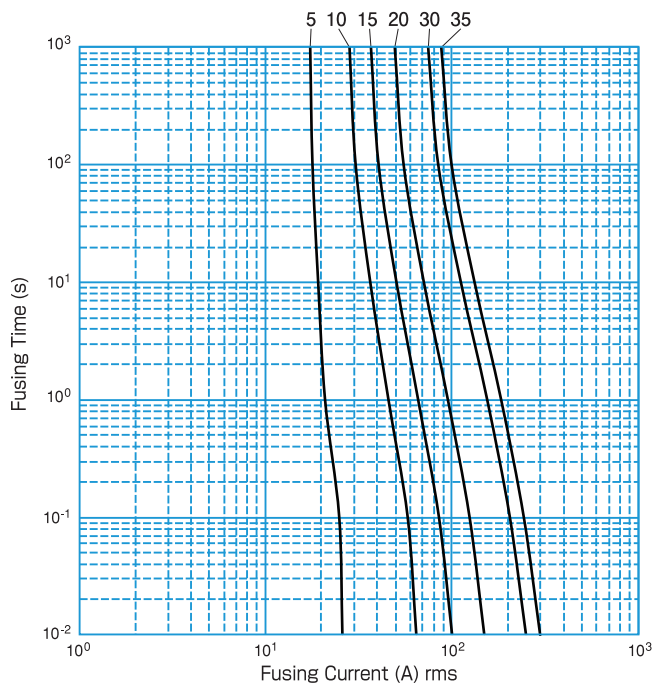

Current-Limiting Characteristics

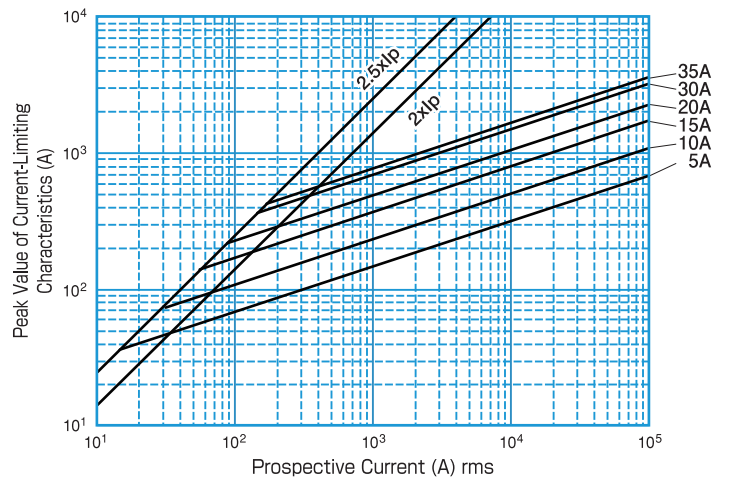

Temperature Rise

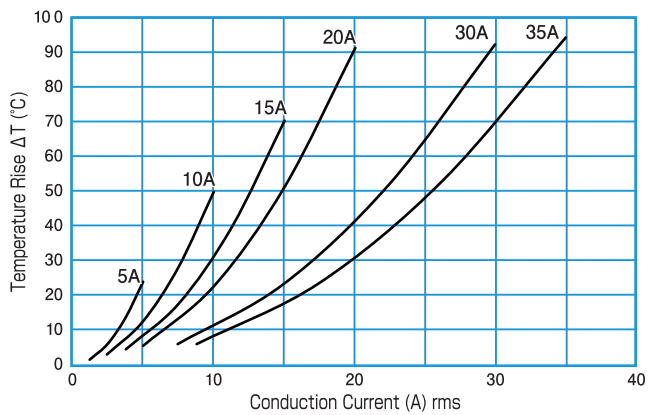

Power Loss

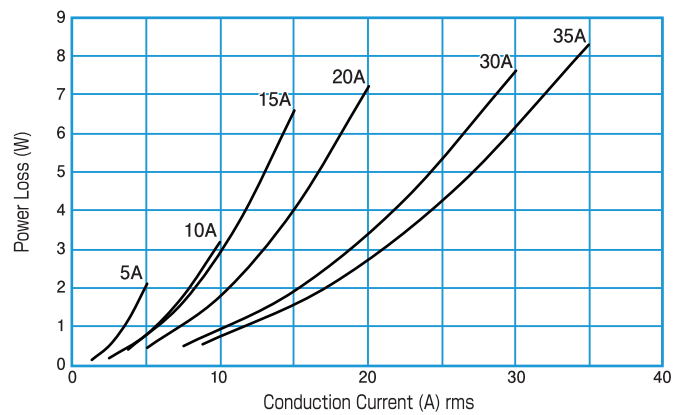

Shutdown I²t Against Working AC Voltage

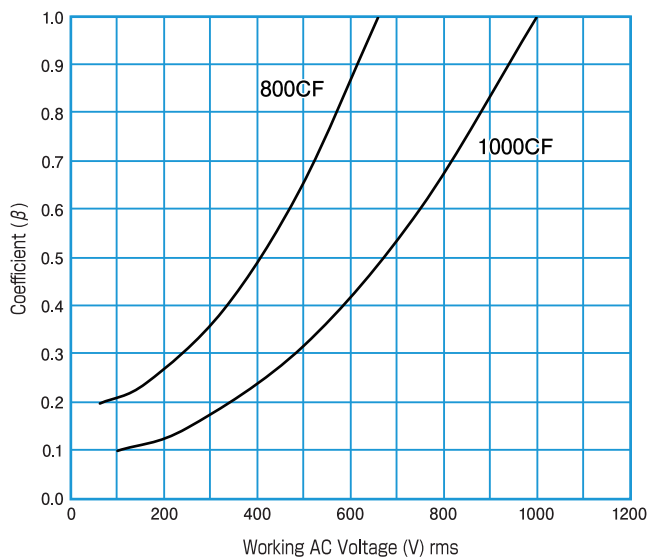

Application to Direct-Current Circuit

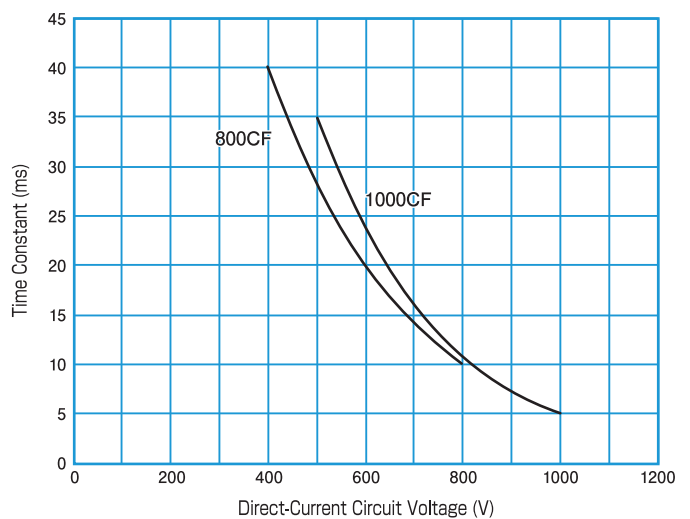

FEATURES

- Requires little installation space on substrates.
- Also compliant to 400V DC.

RATING

Rated voltage and breaking capacity : 380V AC-10kA, 400V DC -10kA(L/R = 2ms)
 Minimum breaking current : 380V AC/400V DC - 8 times the rated amperage
 Maximum arc voltage : 700V

cUL standard approved rating

Same as the standard rating



Specifications

Ta=25°C

Type	Rated Amperage (A)	Fusing I ² t (A ² S)	Shutdown I ² t (A ² S) at AC380V 10kA	Power Loss (W)	Weight (g)
350GHK050UL	50	222	3000	5.1	22.5
350GHK080UL	80	568	6390	10.1	
350GHK100UL	100	888	9150	16.5	

Fusing Characteristics

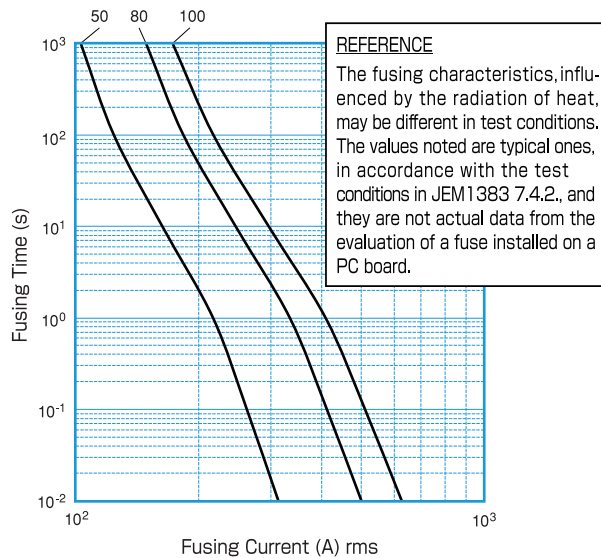

Temperature Rise

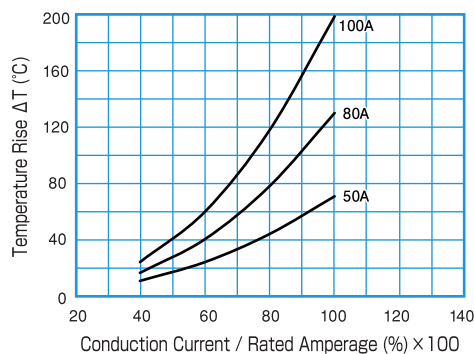

CAUTION!

- Read "FOR SAFE USE" at the back of this catalog before use.
- Fuse should be used less than 50% of their rated current.
- Arc re-ignition may occur if the fusing current is less than 8 times larger than the fuse.
- The power loss and the temperature characteristics are studied using an FR-4 board (one-side board) and a 35-μm-thick copper foil with a copper foil width of 2mm/A depending on the rated amperage (e.g. 50 mm width for a product rated at 100 A).

Dimensions

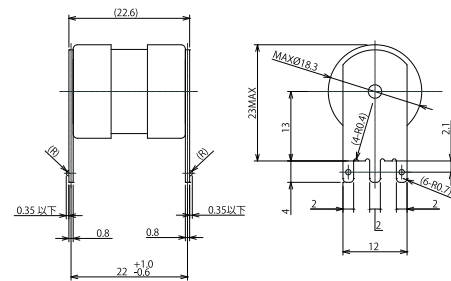

Current-Limiting Characteristics

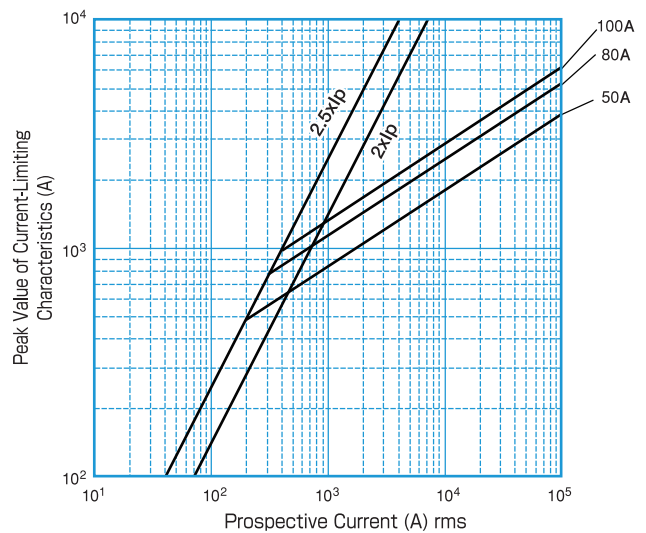

Power Loss

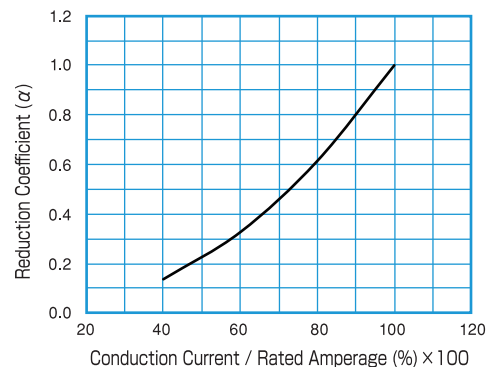

250GH/350GH CYLINDRICAL FAST ACTING FUSES - SCREWING TYPES

FEATURES

- A fuse with a sound alarm that indicates that it has fused is also available (microswitch can be installed).
- Durable against fluctuating electric current.
- Also compliant to 400V DC (350GH)
- Compliant to all kinds of standards.

RATING

● 250GH

Rated voltage and blocking capacity : 250V AC-100kA, 250V DC (L/R = 10ms)-100kA
 Minimum block-off current : 250V AC/DC - 5 times the rated amperage
 Maximum arc voltage : 550V

● 350GH

Rated voltage and blocking capacity : 250/350V AC-100kA, 400V DC (L/R = 2ms)-10kA
 Minimum block-off current : 350V AC/400V DC - 5 times the rated amperage
 Maximum arc voltage : 700V

CAUTION!

- Read "PROTECT FUSE USER'S GUIDE" and "FOR SAFE USE" at the back of this catalog before use.
- When purchasing a product with a sound alarm, enter "S" immediately after the ampere rating in the product name (e.g. 350GH-200SUL).
- The minimum working voltage of the alarm fuse is 10V.

Specifications

Type	Rated Amperage (A)	Fusing I _{Pt} (A ² S)	Shutdown I _{Pt} (A ² S) at AC250V-100KA	Shutdown I _{Pt} (A ² S) at AC350V-100KA	Power Loss (W)	Dimensions (mm)											Weight (g)	Fig	Standard Approved
						A	B	C	D	E	F	G	H	W	T	M			
350GH-16UL	16	20	230	430	1.5	55	41±3	25	27max	17.5	9.5	6.5	19	12	2	27	1	UL US CCC**	
350GH-20UL	20	35	370	680	1.7														
350GH-25UL	25	55	530	980	2.1														
350GH-32UL	32	80	720	1310	3.0														
350GH-40UL	40	142	1150	2090	3.6														
350GH-50UL	50	222	1650	3000	4.7														
350GH-63UL	63	370	2220	4010	6.9														
350GH-80UL	80	568	3540	6390	8.2														
350GH-100UL	100	888	5090	9150	10.0														
250GH-125UL	125	820	6700	—	14.0														
350GH-125UL	125	1280	6950	12280	13.0	78	57±3	29	33max	23	14	9	26	20	3	76	UL US CCC**		
350GH-160UL	160	2275	10950	19540	17.5														
350GH-200UL	200	3555	15740	28000	24.0														
350GH-250UL	250	6480	25670	45450	24.0														
350GH-315UL	315	8000	30470	53860	41.0														
250GH-350UL	350	7400	52000	—	45.0														
250GH-400	400	11000	75000	—	45.0														
250GH-450	450	13500	92000	—	50.0														
250GHW500	500	24000	160000	—	50.0														
250GHW630	630	30000	205000	—	65.0														
250GHW710	710	43000	280000	—	70.0	86	61±3	30	46max	37	13	11	40	30	6	80	380	2	—
250GHW800	800	53000	355000	—	80.0														

Ta=25°C

Dimensions

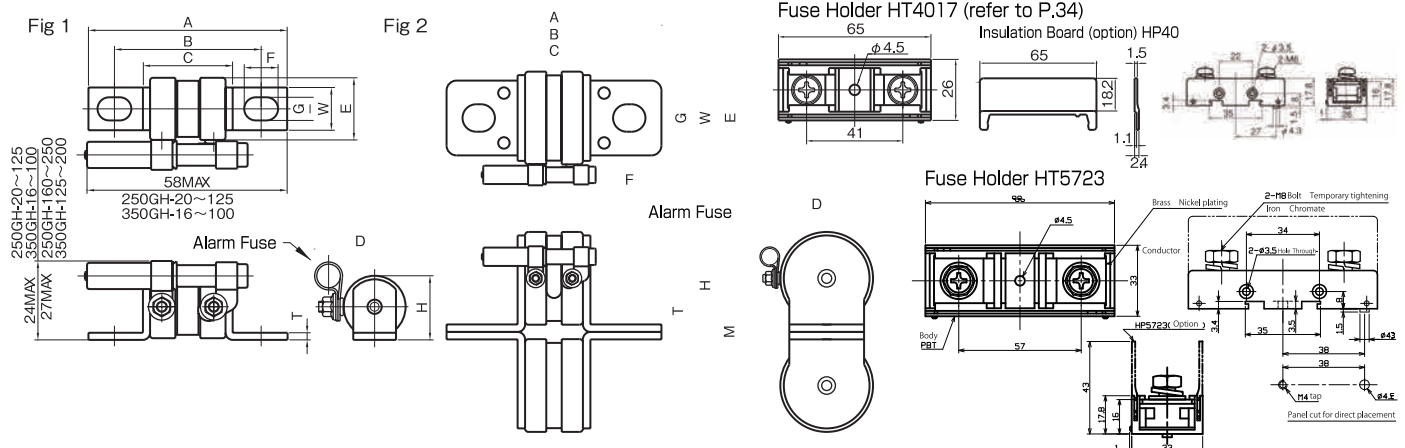

UL /cUL standard approved rating

When applying the standard to UL standard approved items, use the fuse in the following rating.

● 250GH (cUL not approved)

Rated voltage and blocking capacity : 250V AC-100kA, 250V DC (L/R = 10ms)-100kA

● 350GH

Rated voltage and blocking capacity : 380V AC-10kA, 400V DC (L/R = 2ms)-10kA

CCC standard approved rating

● 350GH

When applying the standard to CCC standard approved items, use the fuse in the following rating.

*The CCC standard is an option. Enter "TC" at the end of product name when ordering (e.g. 350GH-100ULTC).

Rated voltage and blocking capacity : 350V AC-50kA, 250V DC (L/R = 10ms)-50kA

250GH

Fusing Characteristics

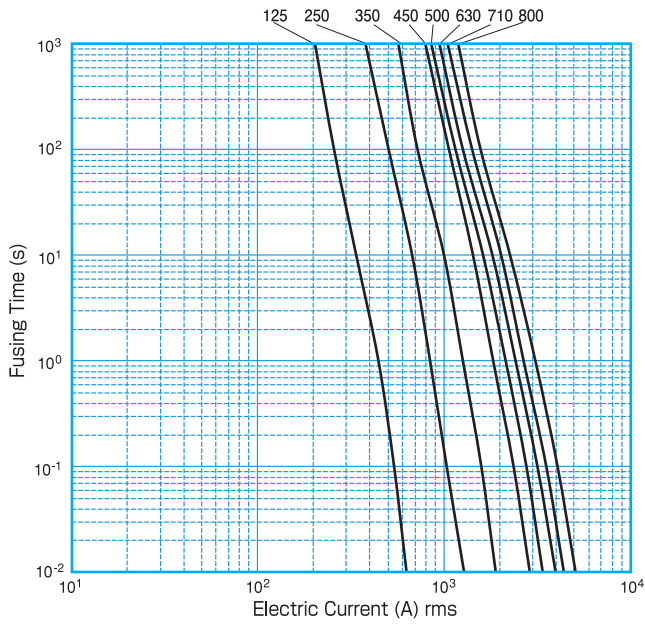

Current-Limiting Characteristics

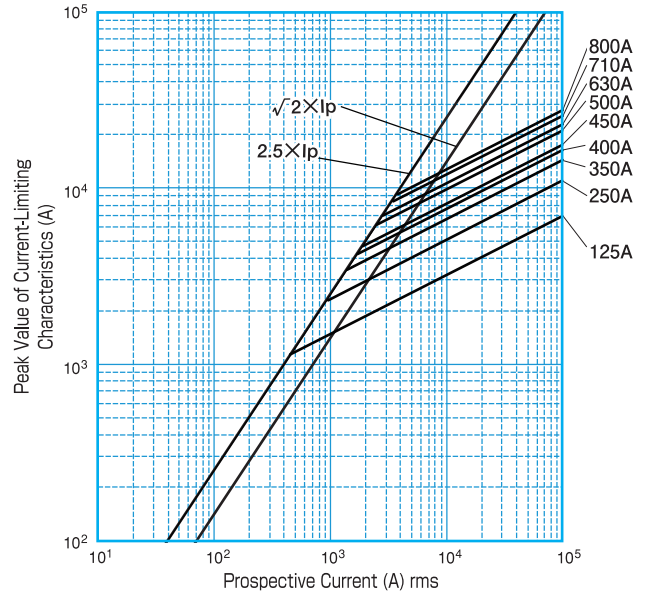

Temperature Rise

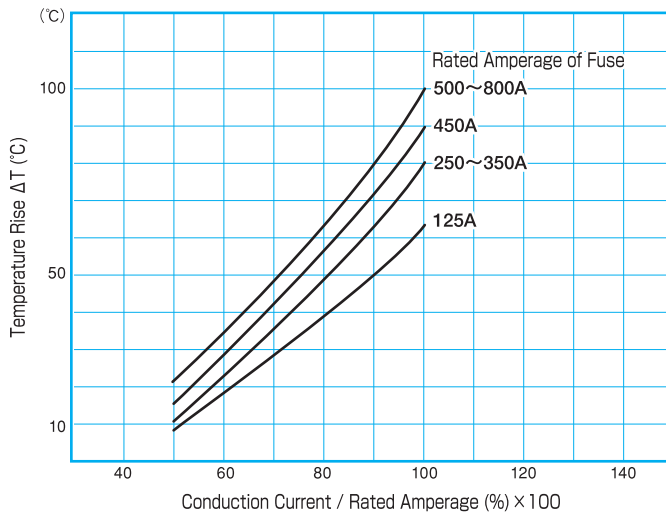

Power Loss

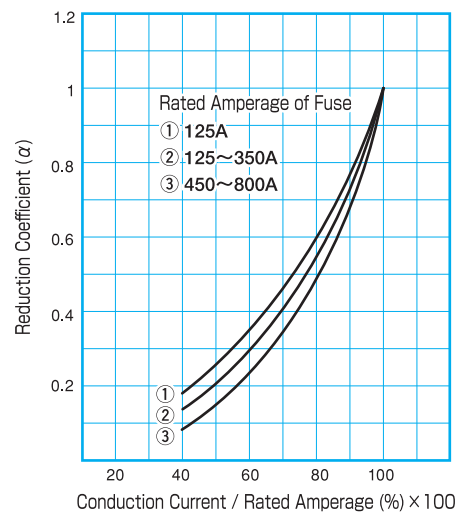

Shutdown I^2t Against Working AC Voltage

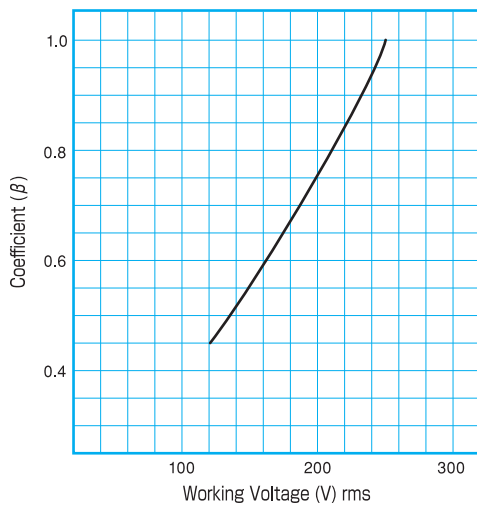

Application to Direct-Current Circuit

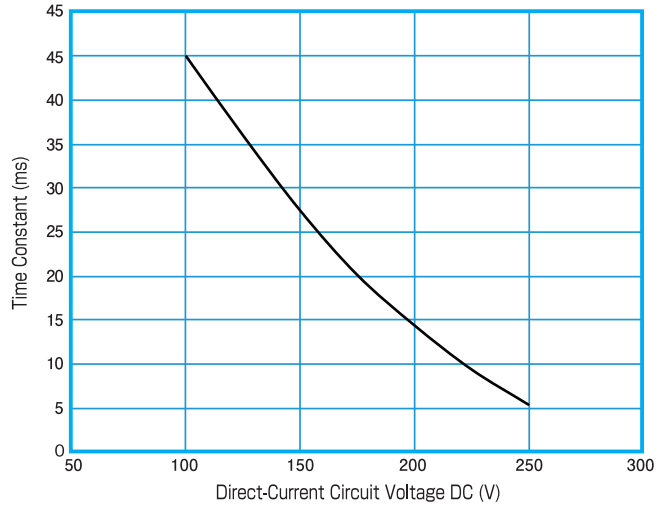

350GH

Fusing Characteristics

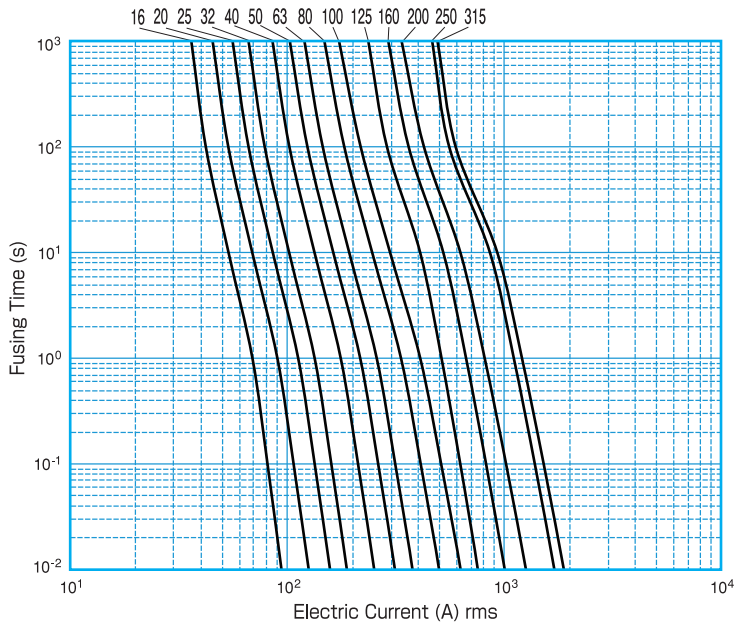

Current-Limiting Characteristics

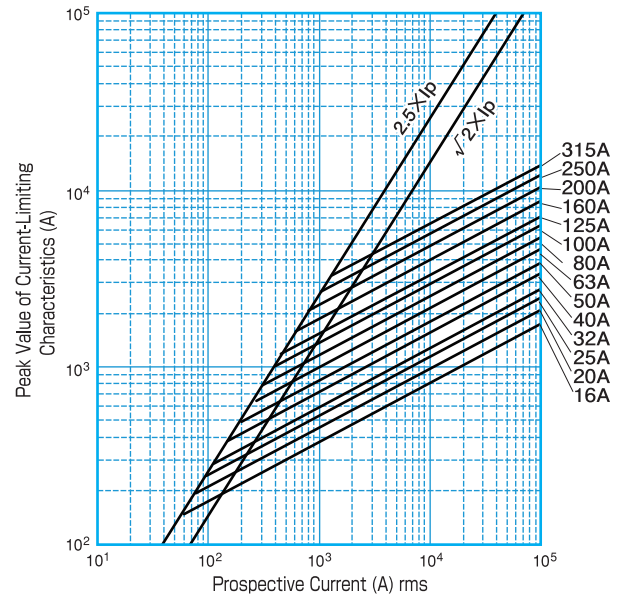

Temperature Rise

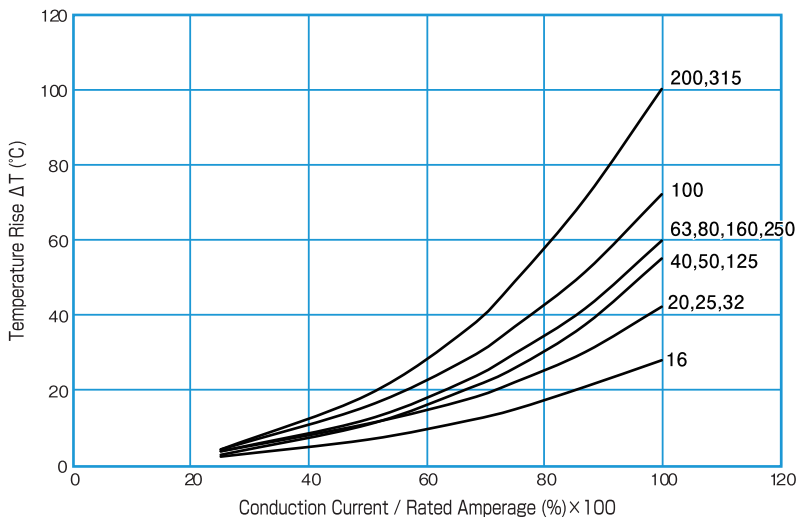

Power Loss

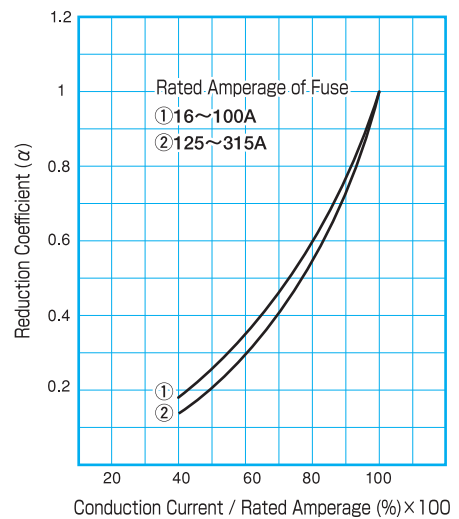

Shutdown I_{st} Against Working AC Voltage

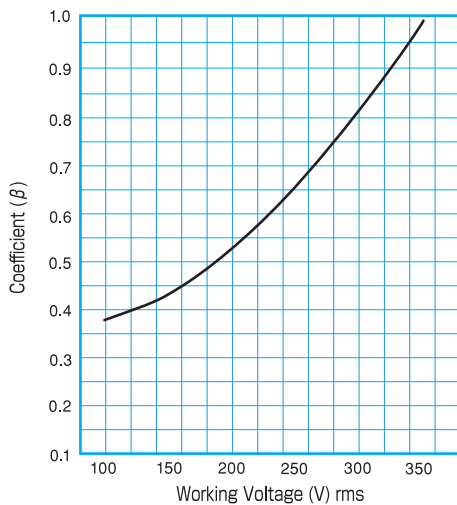

Application to Direct-Current Circuit

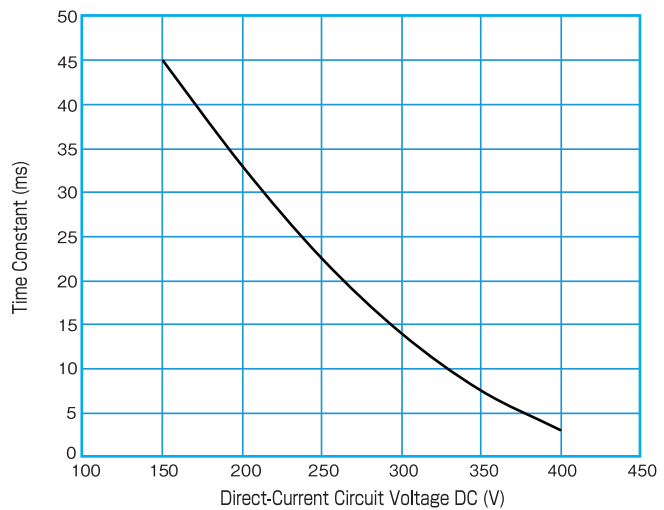

CYLINDRICAL FAST ACTING FUSES - SCREWING TYPES

Fusing Characteristics

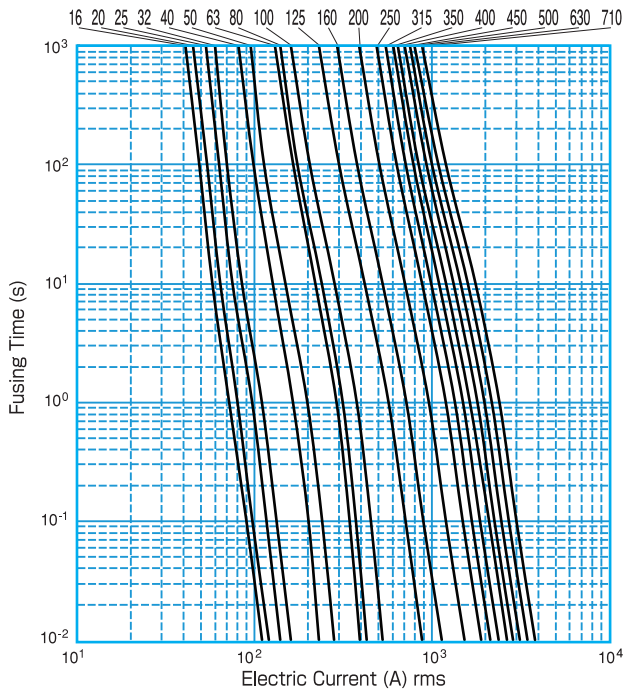

Current-Limiting Characteristics

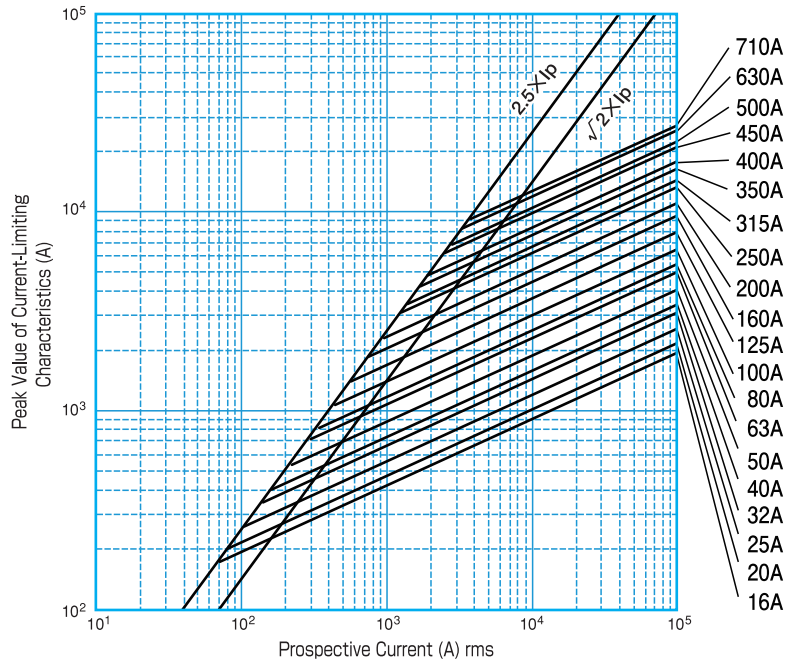

Temperature Rise

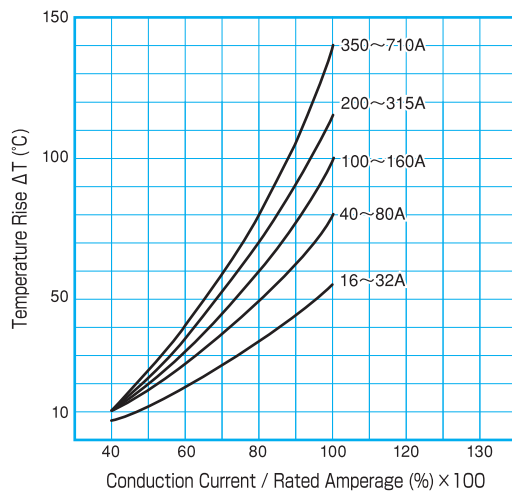

Power Loss

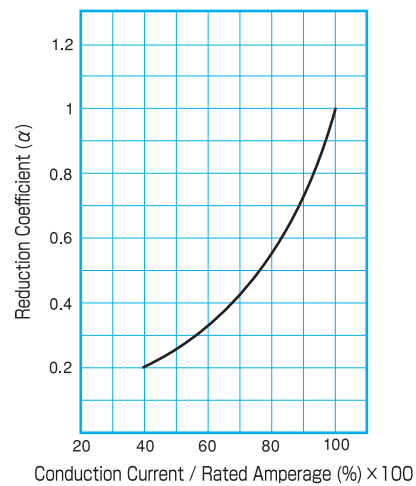

Shutdown I^2t Against Working AC Voltage

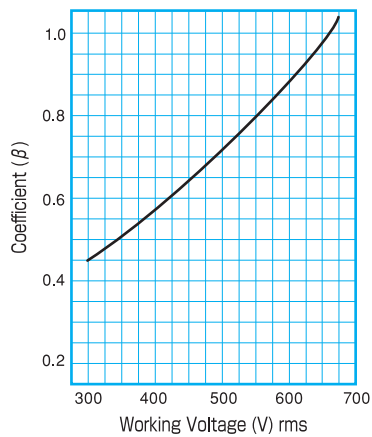

Application to Direct-Current Circuit

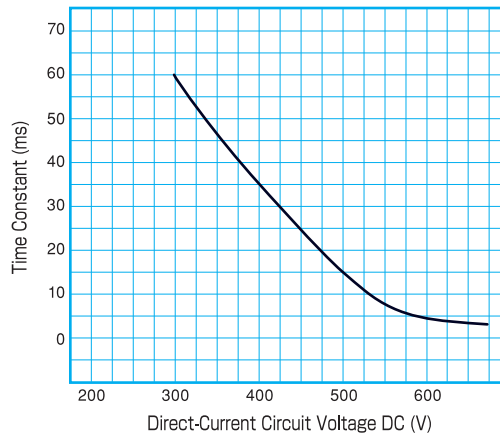

750GHK

CYLINDRICAL FAST ACTING FUSES - SCREWING TYPES

FEATURES

- 750GHK series is a substrate-mounted fuse, effectively reducing power and space requirements.
(Suitable for inverter, UPS, power supply use)
- High voltage (AC850 DC750)
-Same fuse size as 660GHK series-

RATING

Rated voltage and breaking capacity

UL recognized: 850V AC-10kA, 750V DC-10kA (L/R=2ms)

CCC recognized: 850V AC-50kA, 600V DC-50kA (L/R=10ms)

Minimum breaking current: 850V AC/750V DC-8 times the rated amperage

Maximum arc voltage: 1900V

Specifications

Ta=25°C

Type	Rated Amperage (A)	Fusing I ² t (A ² S)	Shutdown I ² t (A ² S) at AC850V 10kA	Power Loss (W)	Weight (g)
750GHK050ULTC	50	311.5	7100	9.3	34
750GHK080ULTC	80	553.8	9500	18.0	
750GHK100ULTC	100	865.3	12000	21.5	



CAUTION!

- Read "FOR SAFE USE" at the back of this catalog before use.
- Fuse should be used less than 50% of their rated current.
- Arc re-ignition may occur if the fusing current is less than 8 times larger than the fuse.
- The power loss and the temperature characteristics are studied using an FR-4 board (one-side board) and a 35-μm-thick copper foil with a copper foil width of 2mm/A depending on the rated amperage (e.g.50mm width for a product rated at 100A).

Dimensions

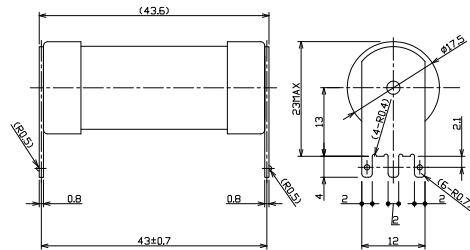

Fusing Characteristics

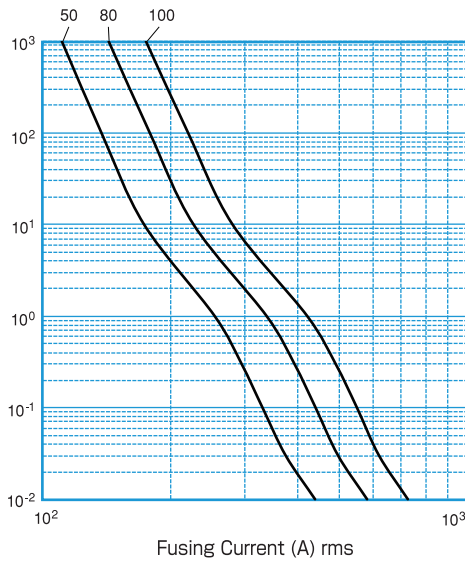

Current-Limiting Characteristics

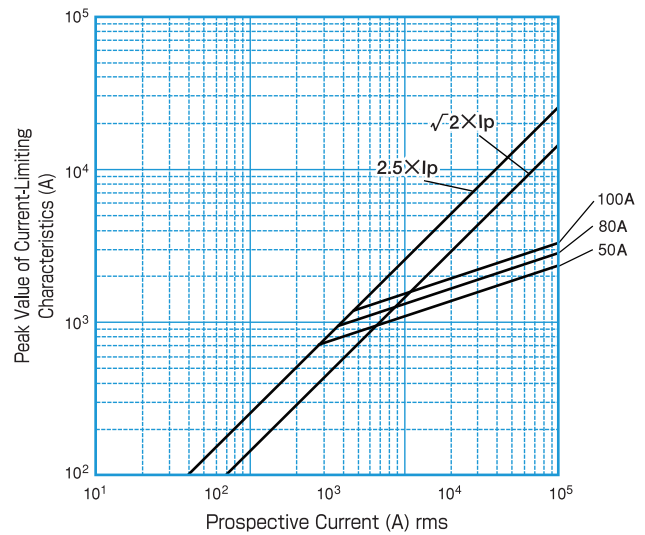

Temperature Rise

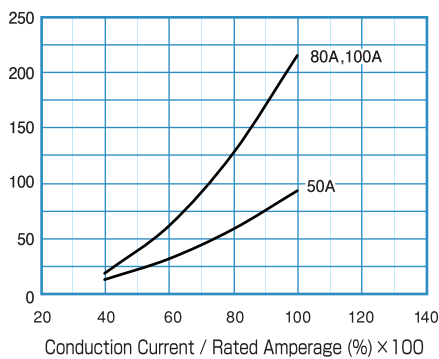

Power Loss

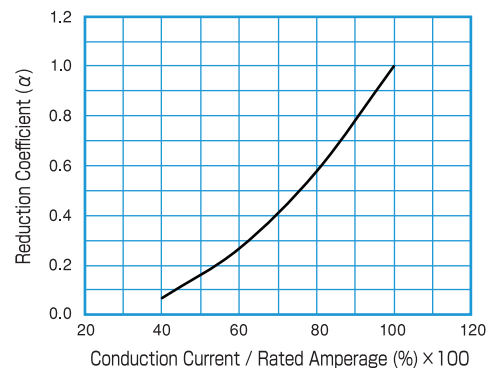

750GH

FEATURES

- A fuse with a sound alarm that indicates that it has fused is also available (microswitch can be installed).
- Durable against fluctuating electric current.
- Compliant to all kinds of standards.
- It is also effective as a fuse with high blocking performance for systems operating at 200V.

RATING

Rated voltage and blocking capacity: AC850V-10kA/DC750V-10kA(L/R2ms)

Minimum block-off current: AC850V/DC750V-8 times the rated amperage

Maximum arc voltage: 1900V

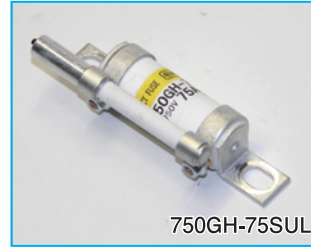

UL standard approved rating

Rated voltage and blocking capacity: Same as the standard rating.

CAUTION!

- Read "FOR SAFE USE" at the back of this catalog before use.
- When purchasing a product with a sound alarm, enter "S" immediately after the ampere rating in the product name (e.g. 660GH-100SUL).
- The minimum working voltage of the alarm fuse is 10 V.

Specifications

Ta=25°C

Type	Rated Amperage (A)	Fusing It (A ² S)	Shutdown I ₂ t (A ² S) at AC850V 10kA	Power Loss (W)	Dimension (mm)											Weight (g)	Standard Approved
					A	B	C	D	E	F	G	H	T	W	M		
750GH-50UL	50	311.5	7100	9.3	76.7	62.7	46	27max	18.5max	9.5	6.5	18	2	12	—	41	UL CS
750GH-63UL	63	424.0	8300	11.1													
750GH-75UL	75	553.8	9500	15.7													
750GH-80UL	80	553.8	9500	18.0													
750GH-100UL	100	865.3	12000	21.5													
750GH-125UL	125	1695.9	17000	21.1	98	78	50	32max	25	14	9	26	3	20	—	100	UL CS
750GH-160UL	160	2803.5	22000	29.2													
750GH-200UL	200	4188.0	26000	43.9													
750GH-250UL	250	7787.5	36000	48.7	108	82±4	51	51max	31	16	10.5	34	3	25	—	180	UL CS
750GH-300UL	300	9422.9	39000	92.3													
750GH-315UL	315	9422.9	39000	102.6													

Dimensions

Fig 1

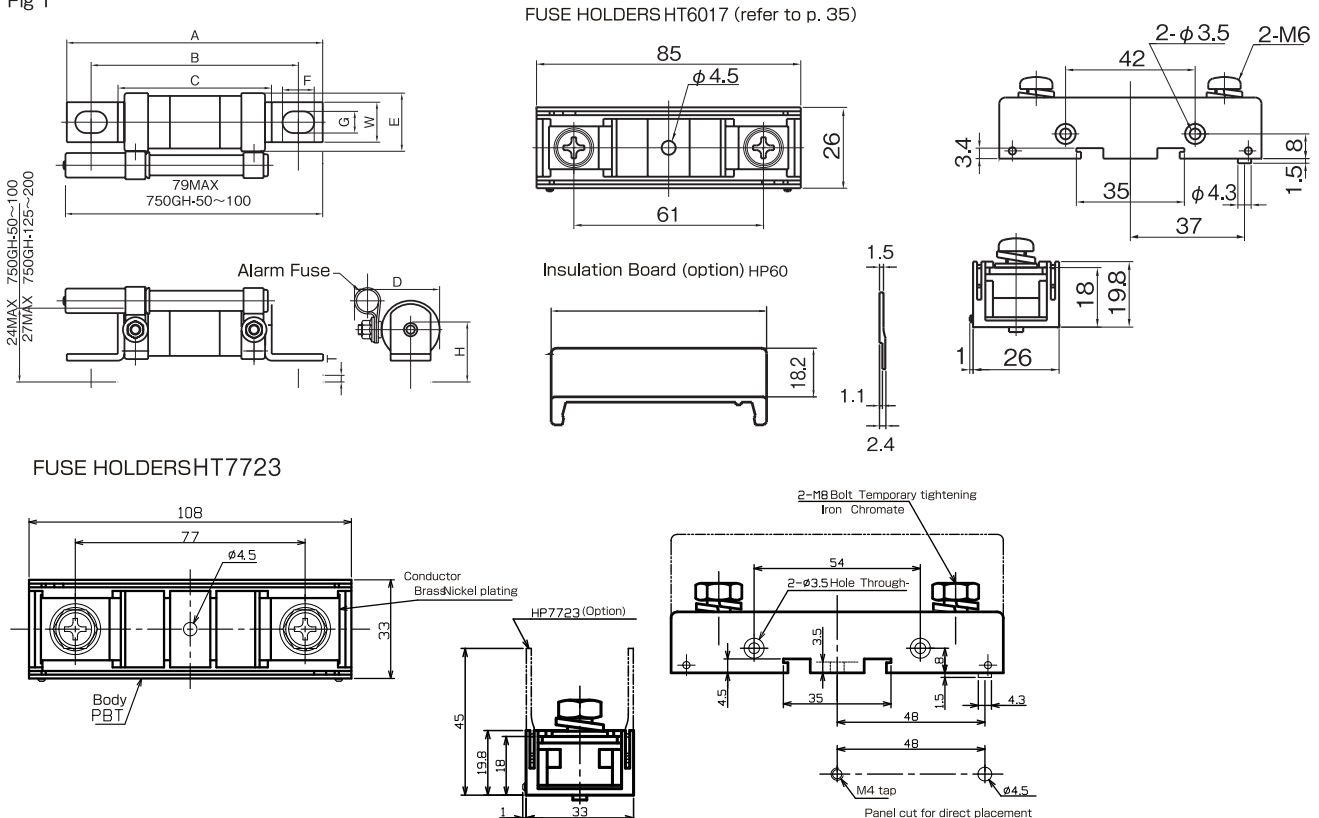

Fusing Characteristics

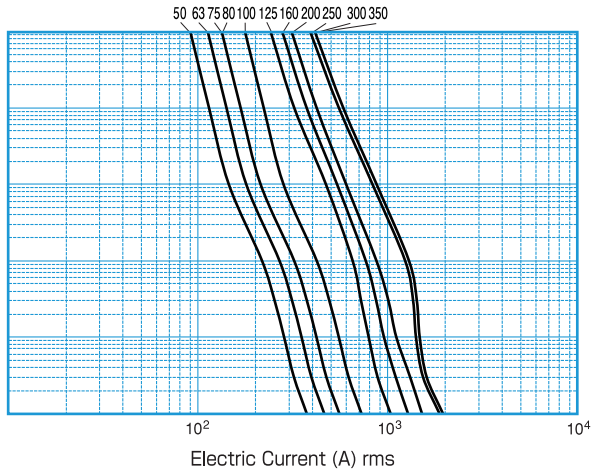

Current-Limiting Characteristics

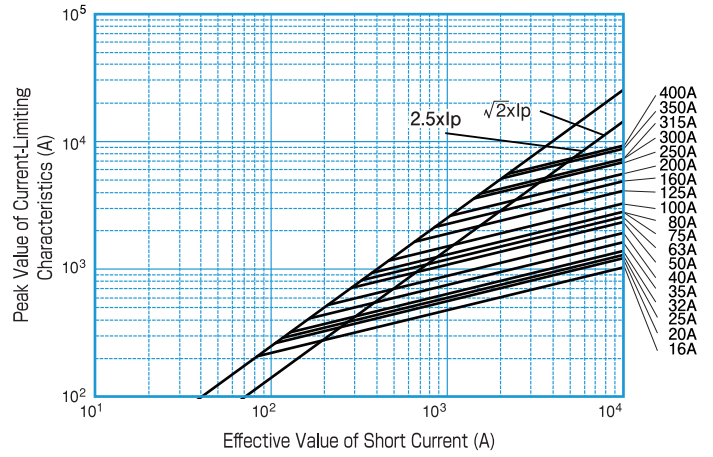

Temperature Rise

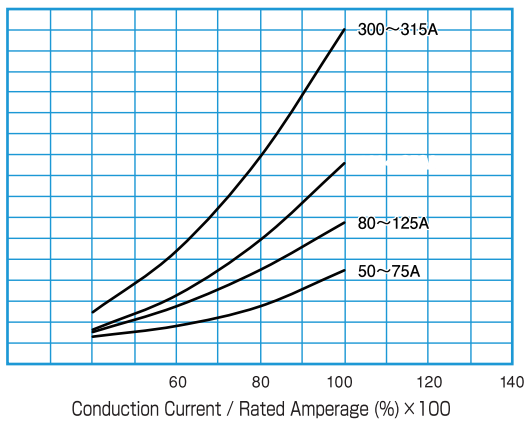

Power Loss

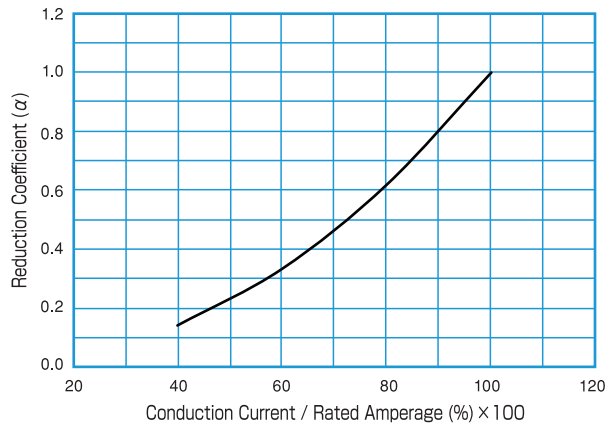

1000GH

FEATURES

- A fuse with a sound alarm that indicates that it has fused is also available (microswitch can be installed).
- Low-cost cylindrical fuse that is compliant to 1000V.
- It is also effective as a fuse with high blocking performance for systems operating at 400V.

RATING

Rated voltage and blocking capacity : 1000V AC-100KA
 1000V DC (L/R = 3ms)-100KA
 Minimum block-off current : 1000V AC/DC - 6 times the rated amperage
 Maximum arc voltage : 2000V



UL standard approved rating

Rated voltage and blocking capacity: Same as the standard rating

CAUTION!

- Read "PROTECT FUSE USER'S GUIDE" and "FOR SAFE USE" at the back of this catalog before use.
- When purchasing a product with a sound alarm, enter "S" immediately after the ampere rating in the product name (e.g. 1000GH-100SUL).
- The minimum working voltage of the alarm fuse is 10 V.

Specifications

Ta=25°C

Type	Rated Amperage (A)	Fusing I ² t (A ² S)	Shutdown I ² t (A ² S) at AC1000V 100KA	Power Loss (W)	Dimensions (mm)										Weight (g)	Fig	Standard Approved	
					A	B	C	D	E	F	G	H	W	T				
1000GH-16UL	16	20	230	3.6	95	81	66	27	20	8	6.5	22	14	2	64	1	UL	
1000GH-20UL	20	30	350	4.5														
1000GH-25UL	25	50	600	5.0														
1000GH-32UL	32	85	900	6.0														
1000GH-40UL	40	145	1400	8.0														
1000GH-50UL	50	230	2300	12.0														
1000GH-63UL	63	330	3200	25.0														
1000GH-80UL	80	580	5500	28.0														
1000GH-100UL	100	1000	8500	30.0	126	99	69	39	31	16	10.5	35	25	3	196			
1000GH-125UL	125	1650	15500	42.0														
1000GH-160UL	160	2500	22000	65.0	127	101	70	44	37	13	11	40	30	3	282			
1000GH-200UL	200	4000	35000	75.0														
1000GH-250UL	250	6600	62000	90.0														
1000GH-315UL	315	10000	90000	120.0														
1000GH-400UL	400	16000	145000	155.0	127	101	70	44	37	13	11	40	30	6	570			2
1000GH-500UL	500	26400	250000	190.0														
1000GH-630UL	630	39500	370000	250.0														

Dimensions

Fig 1

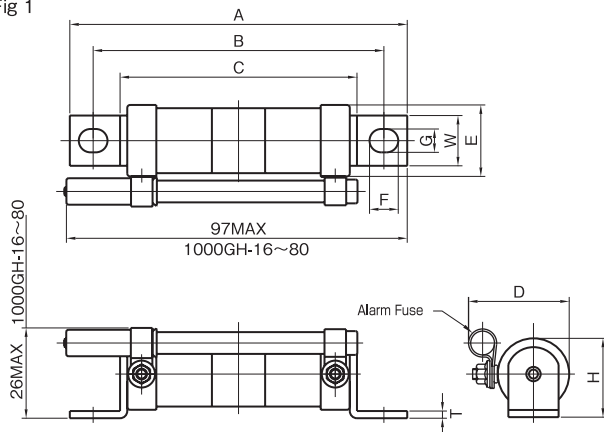
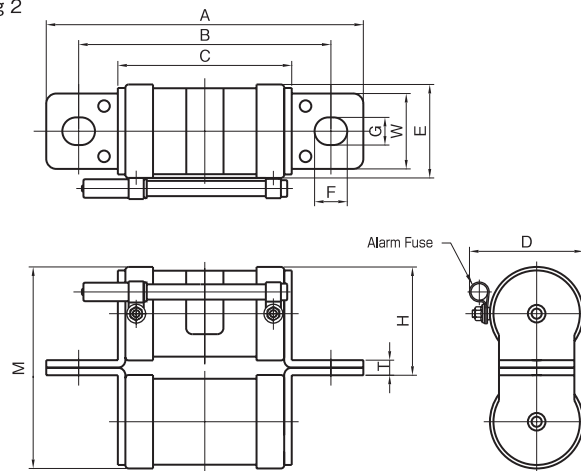
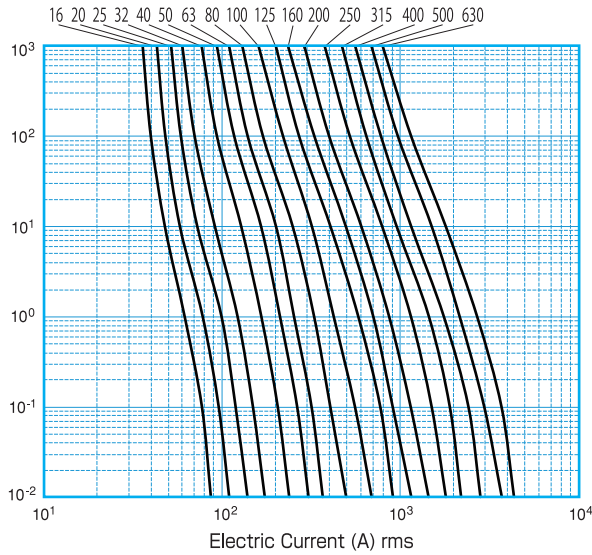

Fig 2



CYLINDRICAL FAST ACTING FUSES - SCREWING TYPES

Fusing Characteristics



Current-Limiting Characteristics

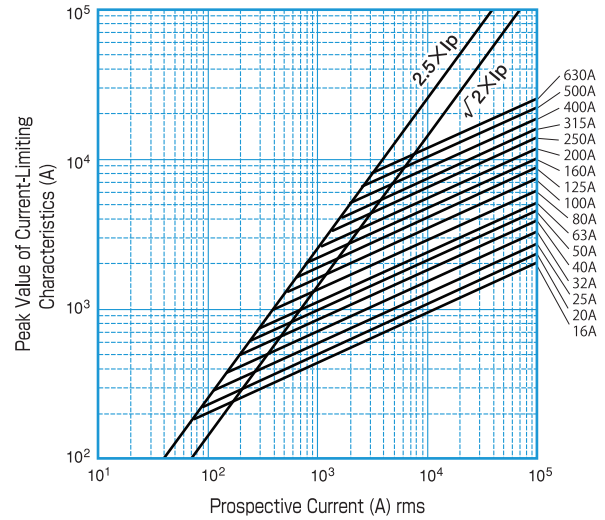

Temperature Rise

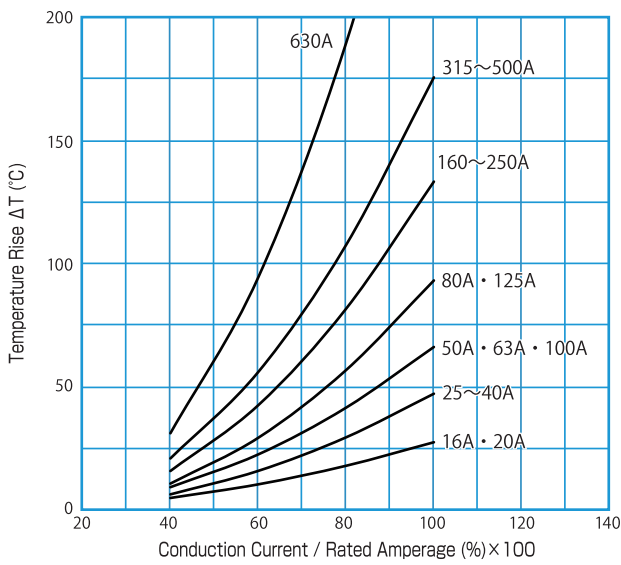

Power Loss

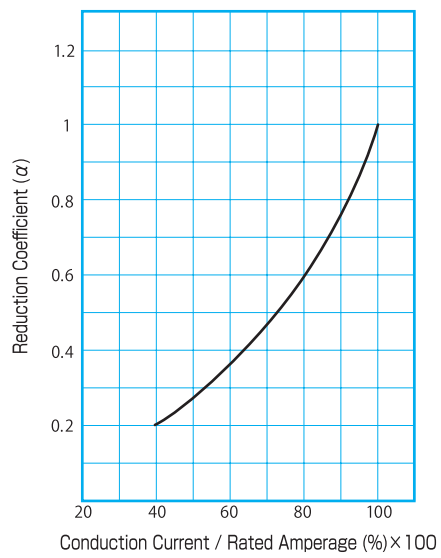

Shutdown I²t Against Working AC Voltage

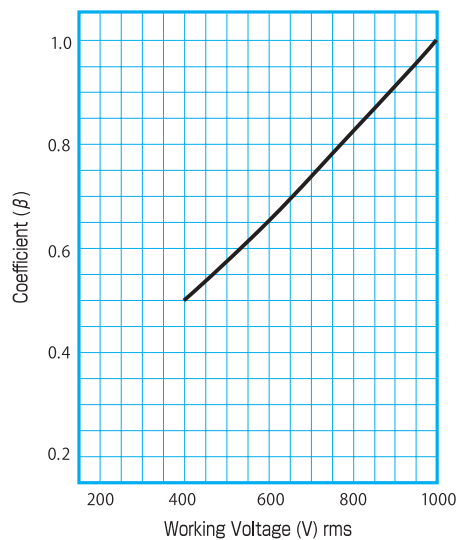

Application to Direct-Current Circuit

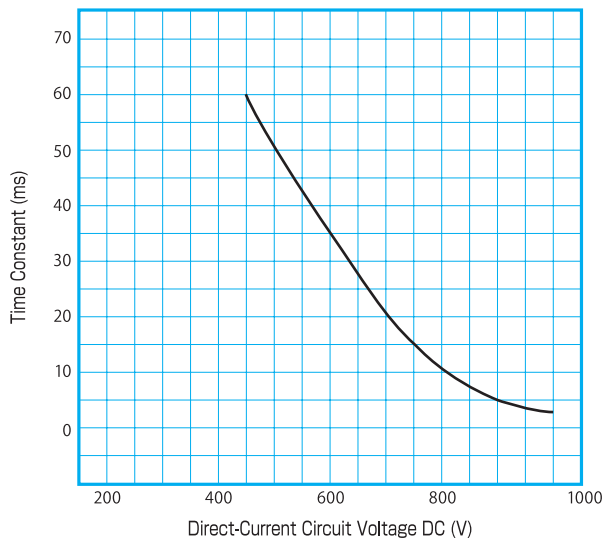

600SPF

FEATURES

- Large capacity, 1750A
- Square type; capable of being connected with copper bars
- Standard model equipped with function to indicate fusing
- Microswitch can be installed (optional)

RATING

Rated voltage and blocking capacity : 600V AC-100KA
 450V DC (L/R = 3ms)-100KA
 Minimum block-off current : 600V AC/450V DC - 5 times the rated amperage
 Maximum arc voltage : 1200V



UL standard approved rating

Rated voltage and blocking capacity : Same as the standard rating

CAUTION!

- Read "PROTECT FUSE USER'S GUIDE" and "FOR SAFE USE" at the back of this catalog before use.
- The minimum working voltage of the fusing indication function is 10V.

Specifications

Standard Model

Ta=25°C

Type	Rated Amperage (A)	Fusing I ² t (×10 ³ A ² S)	Shutdown I ² t (×10 ³ A ² S) at AC600V 100KA	Power Loss (W)	Dimensions (mm)					Weight (g)	Fig	Standard Approved
					A	B	C	D	M			
600SPF80S	80	0.5	3.5	13	A1=30 A2=43	53	27	50	M8 Depth 8	210	1	—
600SPF100S	100	0.8	6.5	16								
600SPF125S	125	1.2	9.5	17								
600SPF160S	160	1.8	14.5	21								
600SPF200S	200	3.1	25.0	30								
600SPF250S	250	4.8	38.0	35	51	53	38	61	420			
600SPF315S	315	7.0	56.0	40								
600SPF350S	350	12.5	100.0	47	60	53	43	66	M10 Depth 10	630		
600SPF400S	400	16.0	140.0	55								
600SPF500S	500	24.0	205.0	60	75	53	51	75	M12 Depth 12	1010		
600SPF600S	600	33.0	290.0	70								
600SPF630S	630	44.0	400.0	85	100	58	63	87	1830	2	3	
600SPF700S	700	56.0	535.0	95								
600SPF800S	800	70.0	670.0	110	100	58	63	87	M12 Depth 12	2430	2	3
600SPF900S	900	94.0	900.0	115								
600SPF1000S	1000	111.0	1060.0	135	75	73	51	75	M12 Depth 12	3700	3	3
600SPF1250P1S	1250	174.0	1580.0	180								
600SPF1500PS	1500	280.0	2700.0	200	100	78	63	87	M12 Depth 12	5200	3	3
600SPF1750PS	1750	450.0	4500.0	250								

UL Approved Model

Type	Rated Amperage (A)	Fusing I ² t (×10 ³ A ² S)	Shutdown I ² t (×10 ³ A ² S) at AC600V 100KA	Power Loss (W)	Dimensions (mm)					Weight (g)	Fig	Standard Approved
					A	B	C	D	M			
600SPF100SUL	100	0.8	6.5	16	A1=30 A2=43	53	27	50	M8 Depth 8	210	1	UL
600SPF125SUL	125	1.2	9.5	17								
600SPF160SUL	160	1.8	14.5	21								
600SPF200SUL	200	3.1	25.0	30								
600SPF250SUL	250	4.8	38.0	35								
600SPF315SUL	315	7.0	56.0	40	51	53	38	61	420			
600SPF350SUL	350	12.5	100.0	47								
600SPF400SUL	400	16.0	140.0	55	60	53	43	66	M10 Depth 10	630		
600SPF500SUL	500	24.0	205.0	60								
600SPF600SUL	600	33.0	290.0	70	75	53	51	75	M12 Depth 12	1010		
600SPF630SUL	630	44.0	400.0	85								
600SPF700SUL	700	56.0	535.0	95	100	58	63	87	M12 Depth 12	1830		
600SPF800SUL	800	70.0	670.0	110								
600SPF900SUL	900	94.0	900.0	115	100	58	63	87	M12 Depth 12	2430	2	3
600SPF1000SUL	1000	111.0	1060.0	135								

Dimensions

Fig 1

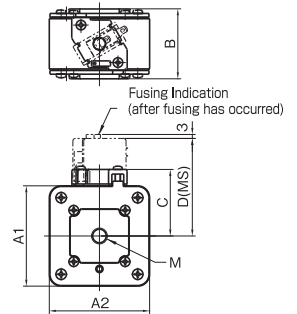

Fig 2

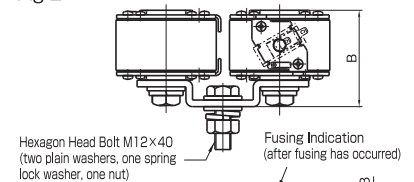
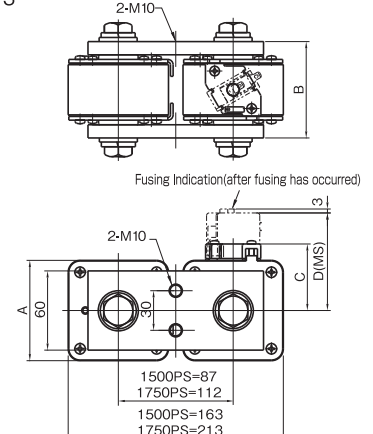
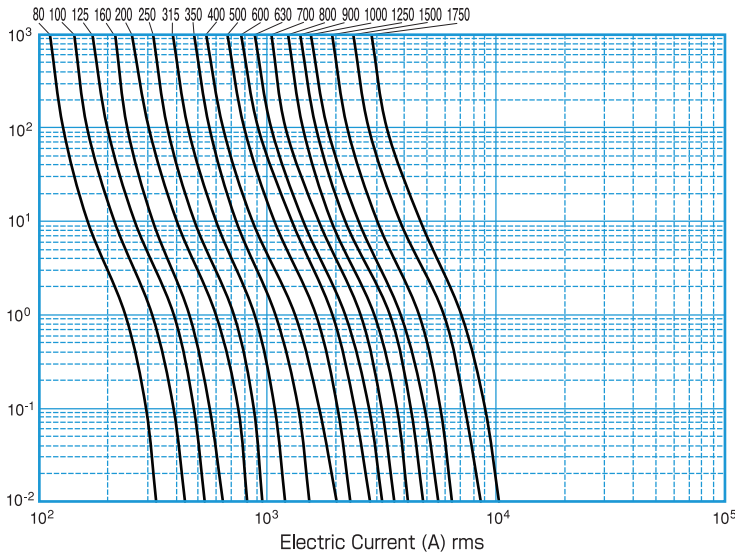

Fig 3



SQUARE FAST ACTING FUSES

Fusing Characteristics



Current-Limiting Characteristics

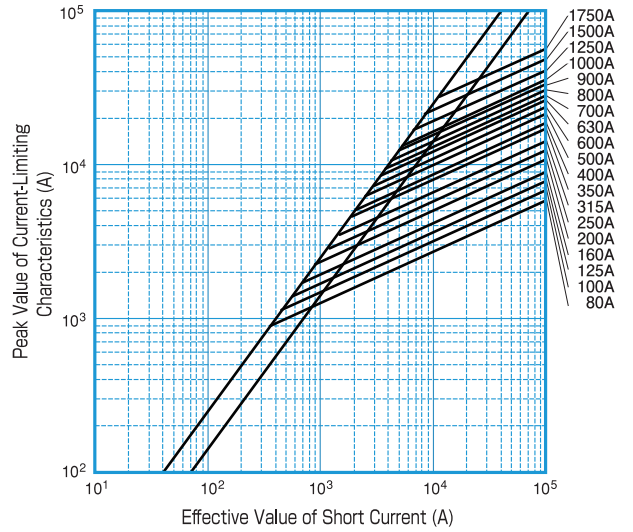

Temperature Rise

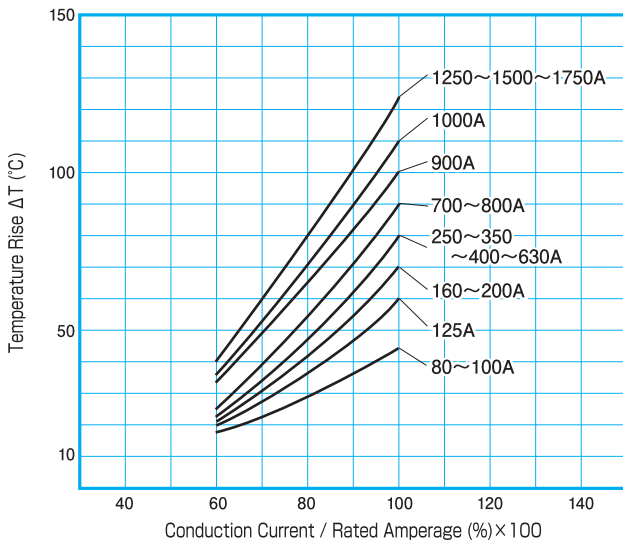

Power Loss

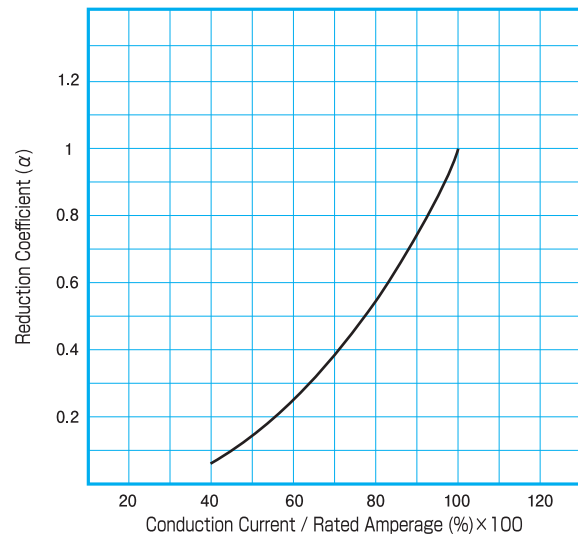

Shutdown I^2t Against Working AC Voltage

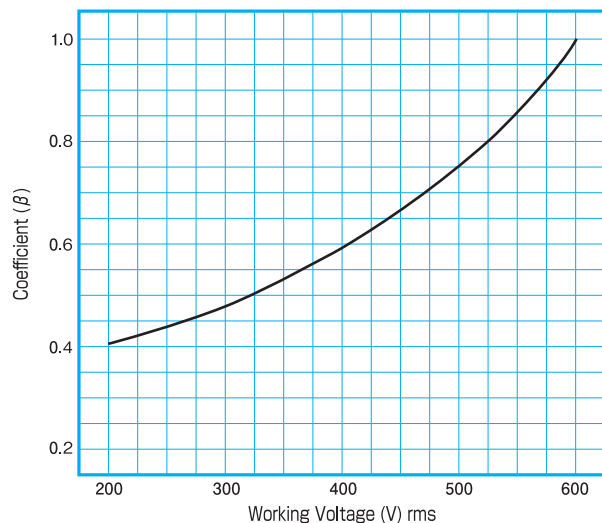

Application to Direct-Current Circuit

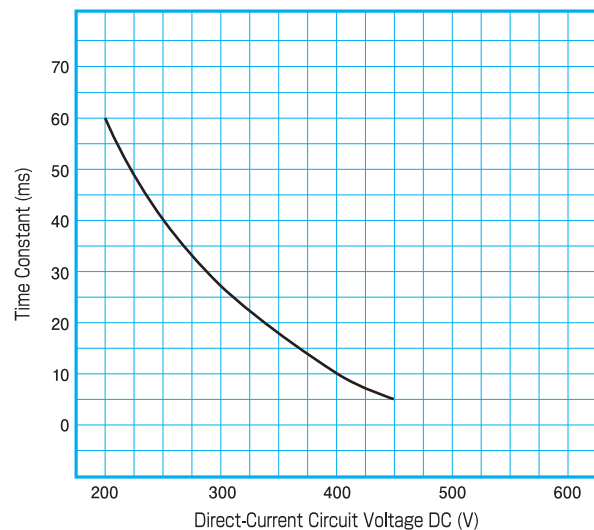

FEATURES

- Large capacity, 1000V-1500A
- Square type; capable of being connected with copper bars
- Standard model equipped with function to indicate fusing
- Microswitch can be installed (optional)



1000SPF500S



1000SPF1000P1S

RATING

Rated voltage and blocking capacity : 1000V AC-100KA
800V DC (L/R = 10ms)-100KA

Minimum block-off current : 1000V AC/800V DC - 7 times the rated amperage
Maximum arc voltage : 2000V

UL standard approved rating

Rated voltage and blocking capacity: Same as the standard rating

CAUTION!

- Read "PROTECT FUSE USER'S GUIDE" and "FOR SAFE USE" at the back of this catalog before use.
- The minimum working voltage of the fusing indication function is 10V.

Specifications

Standard Model

Ta=25°C

Type	Rated Amperage (A)	Fusing I ² t (×10 ³ A ² S)	Shutdown I ² t (×10 ³ A ² S) at AC1000V 100KA	Power Loss (W)	Dimensions (mm)					Weight (g)	Fig	Standard Approved
					A	B	C	D	M			
1000SPF80S	80	0.9	8.0	16	A1=30 A2=43	73	27	50	M8 Depth 8	260	1	—
1000SPF100S	100	1.2	12.0	19								
1000SPF125S	125	2.0	19.0	23								
1000SPF160S	160	3.1	31.0	30								
1000SPF200S	200	4.8	47.0	35								
1000SPF250S	250	6.9	55.0	42								
1000SPF315S	315	12.5	123.0	56								
1000SPF350S	350	16.0	157.0	60								
1000SPF400S	400	23.0	210.0	66								
1000SPF500S	500	33.0	325.0	95								
1000SPF630S	630	63.0	590.0	125	75	73	51	75	M12 Depth 12	1290		
1000SPF700S	700	70.0	670.0	135								
1000SPF800S	800	94.0	900.0	160	100	79	63	87	2300			
1000SPF1000P1S	1000	133.0	1330.0	185	75	93	51	75	M12 Depth 12	3200	2	
1000SPF1250P1S	1250	250.0	2360.0	240	100	99	63	87		6300	3	
1000SPF1500PS	1500	380.0	3700.0	340								

UL Approved Model

Type	Rated Amperage (A)	Fusing I ² t (×10 ³ A ² S)	Shutdown I ² t (×10 ³ A ² S) at AC1000V 100KA	Power Loss (W)	Dimensions (mm)					Weight (g)	Fig	Standard Approved
					A	B	C	D	M			
1000SPF125SUL	125	2.0	19.0	23	51	73	38	61	M8 Depth 8	530	1	UL
1000SPF160SUL	160	3.1	31.0	30								
1000SPF200SUL	200	4.8	47.0	35								
1000SPF250SUL	250	6.9	55.0	42								
1000SPF315SUL	315	12.5	123.0	56								
1000SPF350SUL	350	16.0	157.0	60	60	73	43	66	M10 Depth 10	800		
1000SPF400SUL	400	23.0	210.0	66								
1000SPF500SUL	500	33.0	325.0	95	75	73	51	75	M12 Depth 12	1290		
1000SPF630SUL	630	63.0	590.0	125								
1000SPF700SUL	700	70.0	670.0	135								
1000SPF800SUL	800	94.0	900.0	160	100	79	63	87	2300			

Dimensions

Fig 1

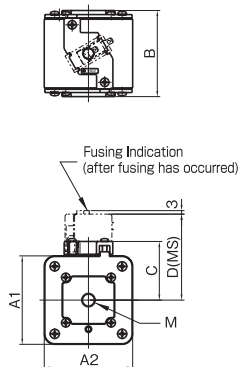

Fig 2

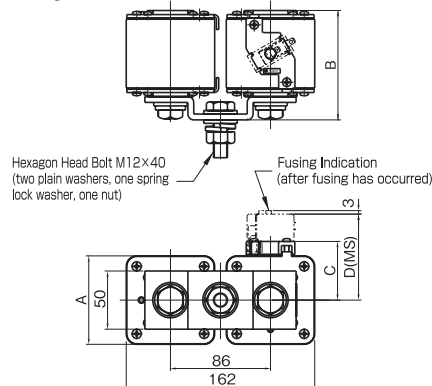
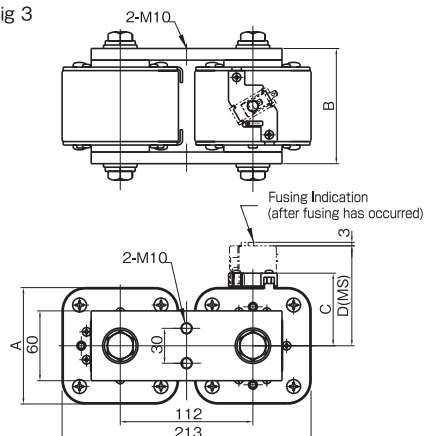
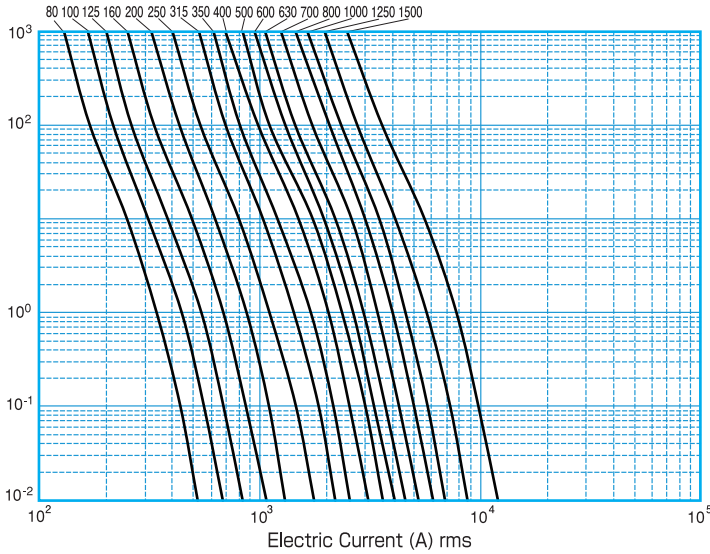

Fig 3



Fusing Characteristics



Current-Limiting Characteristics

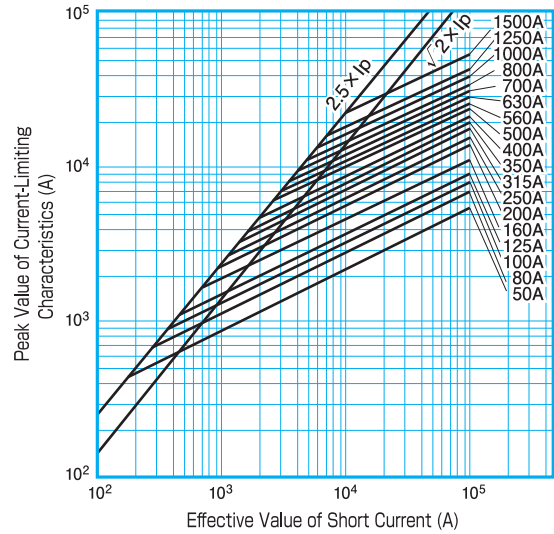

Temperature Rise

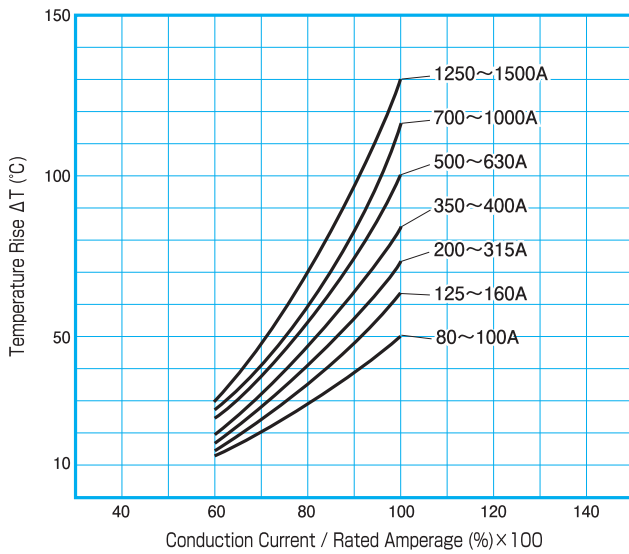

Power Loss

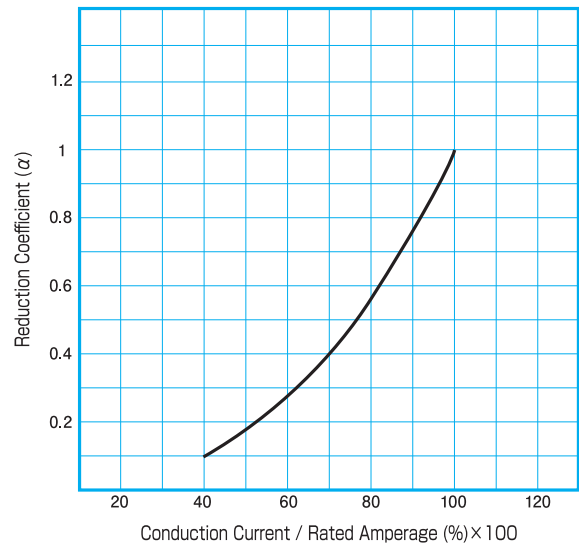

Shutdown I²t Against Working AC Voltage

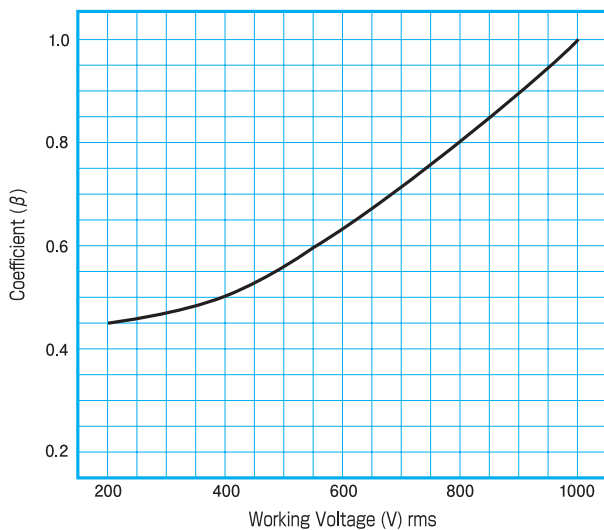

Application to Direct-Current Circuit

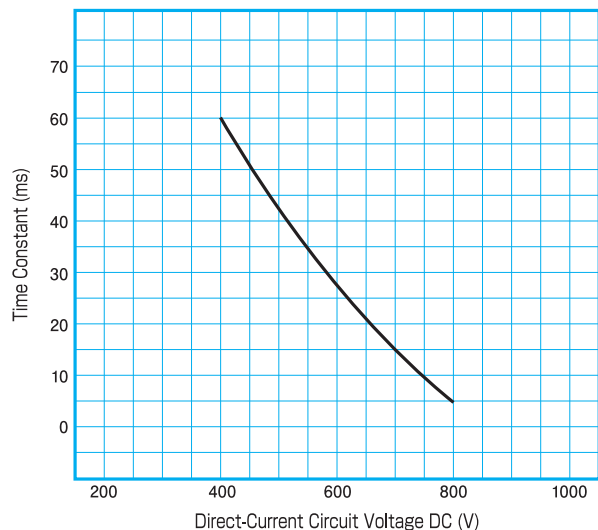

1500SPF

FEATURES

- Large capacity, 1500V-500A
- Square type; capable of being connected with copper bars
- Standard model equipped with function to indicate fusing
- Microswitch can be installed (optional)

RATING

Rated voltage and blocking capacity : 1500V AC-100KA
 Minimum block-off current : 1500V AC - 10 times the rated amperage
 Maximum arc voltage : 3000V

Specifications

Standard Model

Ta=25°C

Type	Rated Amperage (A)	Fusing I ² t (×10 ³ A ² S)	Shutdown I ² t (×10 ³ A ² S) at AC1500V 100KA	Power Loss (W)	Dimensions (mm)					Weight (g)	Fig	Standard Approved
					A	B	C	D	M			
1500SPF50S	50	0.5	3.4	11	A1=30 A2=43	103	27	50	M8 Depth 8	370	1	
1500SPF75S	75	1.0	6.8	20								
1500SPF100S	100	2.0	13.5	29	51	105	38	61	M8 Depth 8	700	1	
1500SPF150S	150	4.0	27.0	40								
1500SPF200S	200	7.9	54.0	63	60	105	43	66	M10 Depth 10	1100	1	
1500SPF250S	250	12.4	111.0	67								
1500SPF300S	300	15.7	149.0	80	75	105	51	75	M12 Depth 12	1700	1	
1500SPF350S	350	23.4	216.0	95								
1500SPF400S	400	27.8	255.0	105								
1500SPF450S	450	37.9	325.0	120								
1500SPF500S	500	49.5	396.0	140								

Dimensions

Fig 1

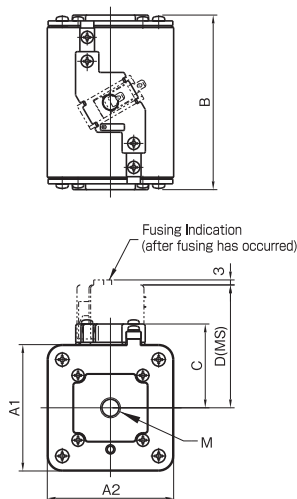

CAUTION!

- Read "PROTECT FUSE USER' S GUIDE" and "FOR SAFE USE" at the back of this catalog before use.
- The minimum working voltage of the fusing indication function is 10V.

Fusing Characteristics

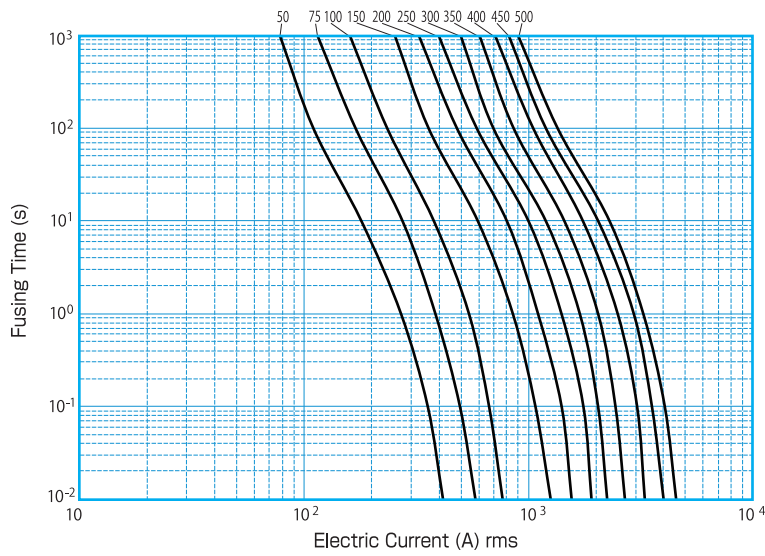

Current-Limiting Characteristics

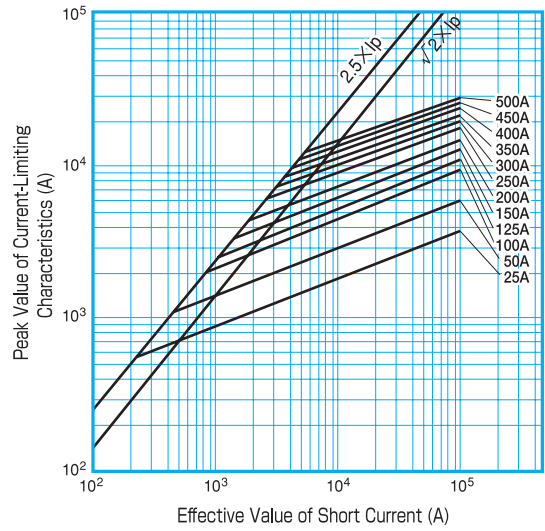

Temperature Rise

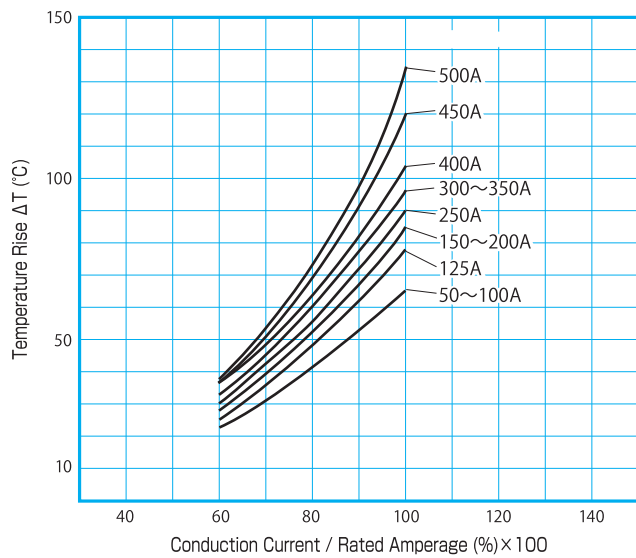

Power Loss

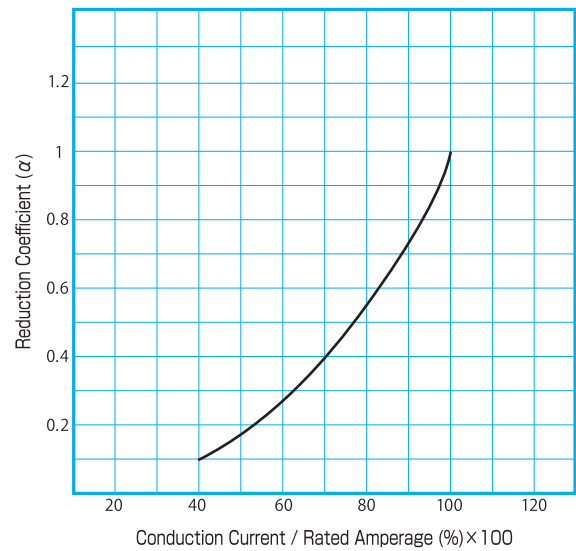

Shutdown I²t Against Working AC Voltage

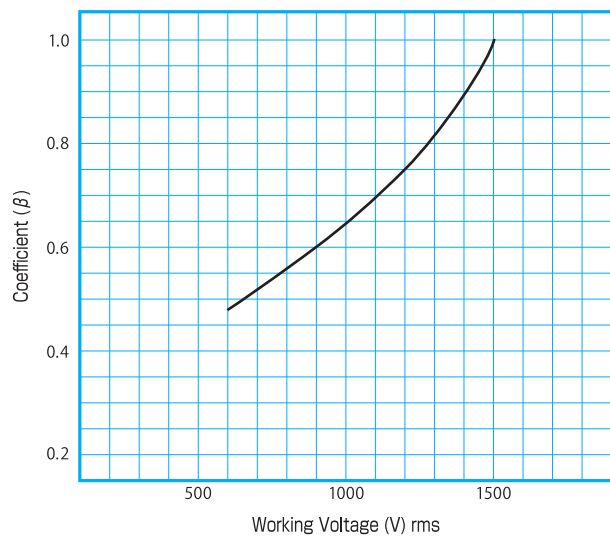

Application to Direct-Current Circuit

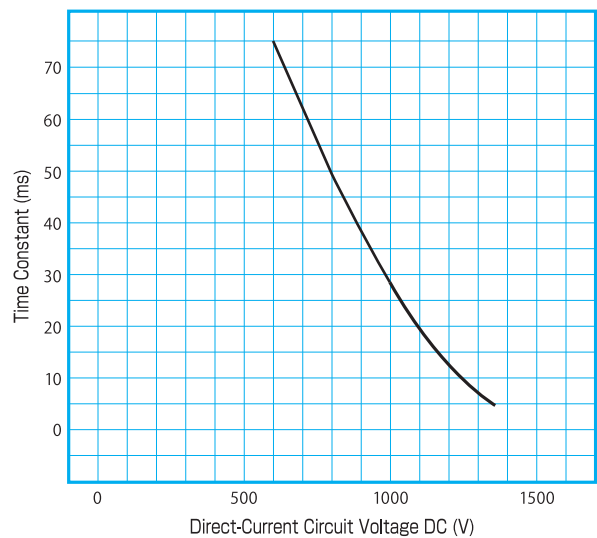

FUSE HOLDERS

◆ For cylindrical fuses

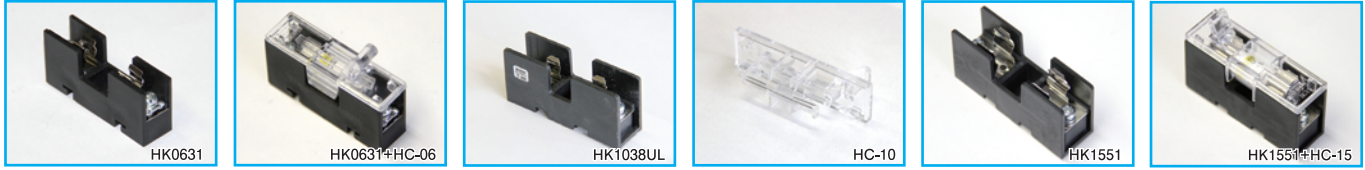

Specifications

	HK0631	HK1038/HK1038UL	HK1551
Rated Voltage	500V	700V	800V
Rated Amperage*1	15A	30A	40A
Applicable Wires	Up to 5.5mm ² (M4)	Up to 8mm ² (M5)	Up to 14mm ² (M5)
Installation	DIN rails and direct installation	DIN rails and direct installation	DIN rails and direct installation
Applicable fuses	φ6.4×31 (Our product 250SF/500SF Series*2)	JIS MF01 [φ10.3×38.1] (Our product 660CF Series*2)	JIS CF2 [φ15×51mm] (Our product 700CF/800CF Series*2)
Material	PBT	PBT	PBT
Name of UL Approved Product	—	HK1038UL	—
Options	Fuse holder cover HC-06	Fuse holder cover HC-10	Fuse holder cover HC-15
Installing Hole Size			

Dimensions

HK0631

HK1038/HK1038UL

HK1551

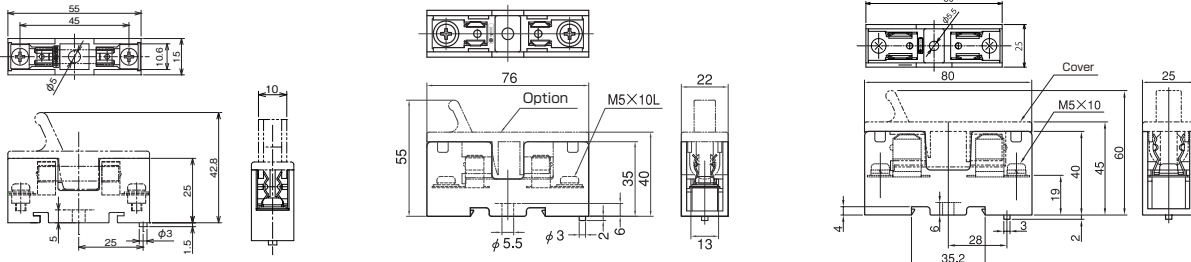

◆ For screwing type fuses

Specifications/Dimensions

HT4017

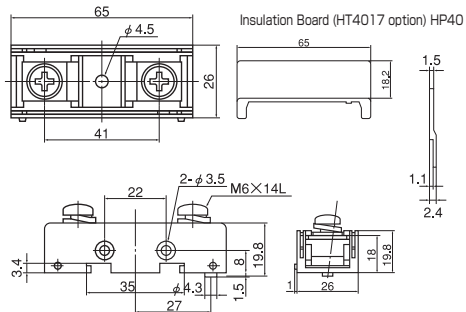

HT4017T2

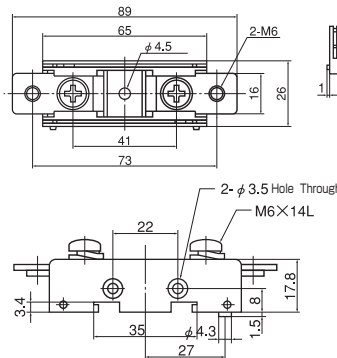

HT5723

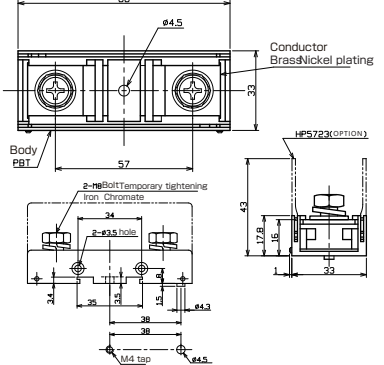

● Specifications

Rated voltage	400V	Applicable fuses	Our product 250FH-20 to 60 250GH-20 to 125*2 350GH-16 to 100*2
Rated amperage	75A*1	Material	PBT
Applicable wires	Up to 22mm ² (M6)	Option	Dashboard HP40 (one can be installed on each side.)
Installation	DIN rails and direct installation		
Installing hole size			

Rated voltage	400V	Applicable fuses	Our product 350GH-125 to 200 250GH-160 to 250*2
Rated amperage	100A*1	Material	PBT
Applicable wires	Up to 38mm ² (M8)		
Installation	DIN rails and direct installation		

Specifications / Dimensions

HT6017

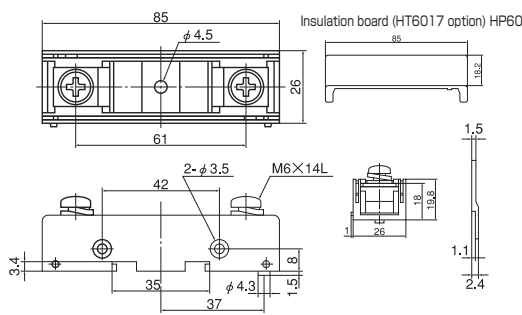

HT6017T2

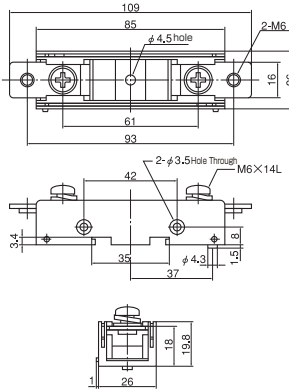

HT7723

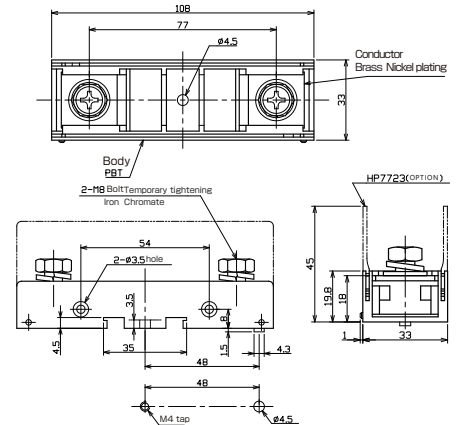

● Specifications

Rated voltage	700V(HT6017T2:660V)	Applicable fuses	Our product 600FH-20 to 55*2 600GH-16 to 100*2
Rated amperage	75A**1	Material	PBT
Applicable wires	Up to 22mm ² (M6)	Option	Dashboard HP60 (one can be installed on each side.)
Installation	DIN rails and direct installation		
Installing hole size			

Rated voltage	800V	Applicable fuses	Our product 660GH-125 to 200 750GH-125 to 200*2
Rated amperage	100A**1	Material	PBT
Applicable wires	Up to 38mm ² (M8)		
Installation	DIN rails and direct installation		

*1 Can be left continuously turned on for long durations.
*2 Use at voltage and current values lower than rated voltage and rated current of fuse holder.

MICROSWITCHES

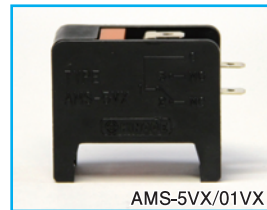
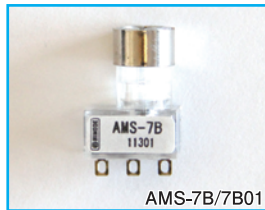

Specifications / Dimensions For GH & GH Series

For SPF Series

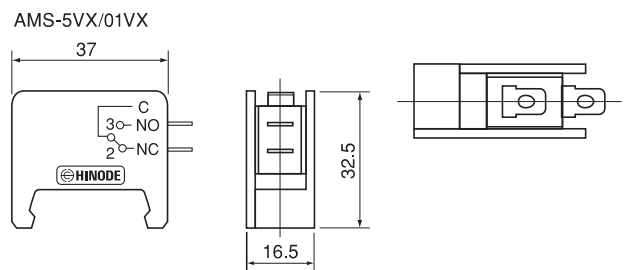
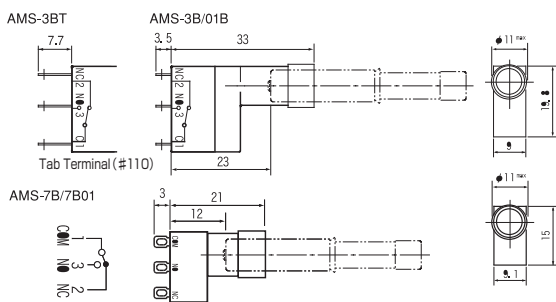

● Specifications

Model	Rated Voltage (V)	Resistive Load (A)	Switch Model
AMS-3B Standard Model	AC250	3	Omron SS-5GL
	DC30	4	
AMS-3BT Tab Terminal	AC250	3	Omron SS-5GLT
	DC30	4	
AMS-01B Very Low-Current Model	AC125	0.1	Omron SS-01GL
	DC30	0.1	
AMS-7 B Standard Model	AC125	3	Omron D2F-D3
	DC30	2	
AMS-7B01 Very Low-Current Model	DC30	0.1	Omron D2F-01-03
	DC5	0.1	

Model	Rated Voltage (V)	Resistive Load (A)	Switch Model
AMS-5VX Standard Model	AC250	5	Omron VX-5-1A3
	DC30	5	
	DC125	0.4	
AMS-01VX Very Low-Current Model	AC250	0.1	Omron VX-01-1A3
	DC8	0.1	
	DC30	.01	

HTM06 / HTM08

FEATURES

- Supports 1000V rated voltage
- Suitable for generic applications
Can be used with 250V, 660V, 1000V and various other fuses



HTM06



HTM

Specifications

	HTM06	HTM08
Rated Voltage	1000V	1000V
Rated Amperage*1	60A	100A
Applicable Wires	Up to 22mm ² (M6)	Up to 38mm ² (M8)
Installation	Direct installation	Direct installation
Insulation Resistance	2000MΩ or higher	2000MΩ or higher
Withstand voltage	AC3000V 50-60Hz 1 minute	AC3000V 50-60Hz 1 minute
Material	PBT	PBT

*1 Current at which continuous current flow is possible.

*2 The sizes for each series are given. In the event of using a fuse with a rated current in excess of 60A(HTM06) or 100A(HTM08), please do not use with a continuous current flow in excess of 60A(HTM06) or 100A(HTM08).

Dimensions

HTM06

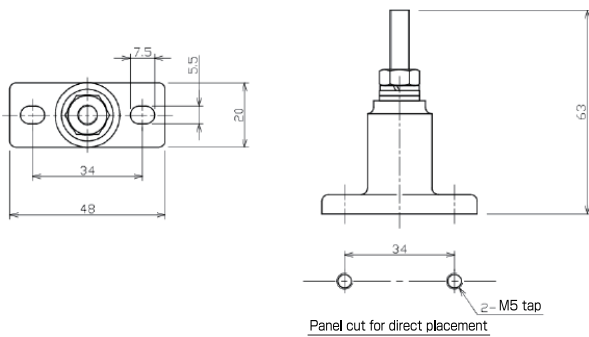

HTM08

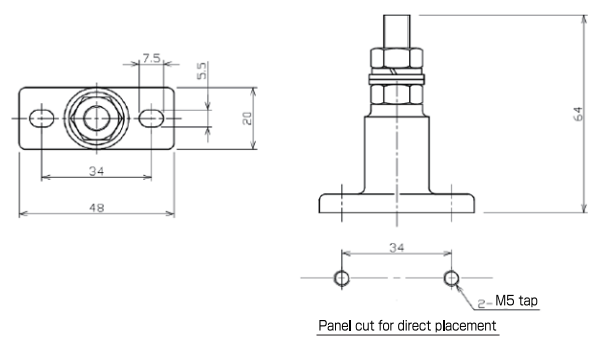

Applicable fuses HTM06

Type	Rated Voltage	Rated Amperage*2
250GH	250V	Up to 125A
250FH	250V	Up to 60A
25FH	250V	Up to 75A
25SHA	250V	Up to 150A
250GA	250V	Up to 150A
25LKA	250V	Up to 100A
350GH	350V	Up to 100A
50SHA	500V	Up to 80A
500GA	500V	Up to 80A
660GH	660V	Up to 100A
600FH	600V	Up to 55A
60FH	600V	Up to 55A
600FHM	600V	Up to 55A
660GA	660V	Up to 75A
66LKA	660V	Up to 100A
660HTP	660V	Up to 100A
600BTP	600V	Up to 125A
750GH	750V	Up to 100A
750FH	750V	Up to 55A
70SHA	700V	Up to 75A
700FH	700V	Up to 75A
1000GH	1000V	Up to 80A
1000SHA	1000V	Up to 50A

Applicable fuses HTM08

Type	Rated Voltage	Rated Amperage*2
250GH	250V	160A~250A
25SH	250V	75A~150A
350GH	350V	125A~200A
660GH	660V	125A~200A
66LKB	660V	100A~200A
660HTP	660V	125A~200A
70SHB	700V	60A~75A
750GH	750V	125A~200A
48LFB	48V	All
96LFB	96V	All

Fuse holder correspondence table / T60 panel cutout dimensions

017 HT4017T2	HP40		250GH-20~125 350GH-16~100 (P18) 250FH-20~60 25FH20~75 250GA-20~60 25LKA20B~100B
HT6017 HT6017T2	HP60		660GH-16~100 (P21) 660GHX125 750GH-16~100 (P24) 600FH-20~55 600FHM20~55 70SHA20~55 66LKA20~75
HT5723 HT5723T2	HP5723	HCT5723	250GH-160~250 350GH-125~200 (P18) 250GG-75~150
HT7723 HT7723T2	HP7723	HCT7723	660GH-125~200 (P21) 750GH-125~200 (P24) 70SHB60~75 66LKB100~200
T-60	—	—	250GH-20~125 350GH-16~100 (P18) 250FH-20~60 25FH20~75 250GA-20~150 25LKA20B~100B 500GA-20~80 660GH-16~100 (P21) 660GHX125 750GH-16~100 (P24) 600FH-20~55 600FHM20~55 70SHA20~75 66LKA20~100 1000GH-16~80 (P26)
			250GH-20~125 350GH-16~100 (P18) 250FH-20~60 25FH20~75 250GA20~150 25LKA20B~100B 500GA-20~80 660GH-16~100 (P21) 660GHX125 750GH-16~100 (P24) 600FH-20~55 600FHM20~55 70SHA20~75 66LKA20~100 1000GH-16~80 (P26)

250GH-20~125 350GH-16~100	16
250FH-20~60	
25FH20~75	
25SHA20~35 250GA-20~35	
25SHA40~60 250GA-40~60	18
25SHA70~150 250GA-70~150	
25LKA20B~100B	30.5
50SHA20~30 500GA-20~30	
50SHA35~55 500GA-35~55	
50SHA60~80 500GA-60~80	
660GH-16~100 660GHX125 660GHS-20~63 660GHS-80 750GH-16~100	36.5
600FH-20~55 750FH-20~55	
60FH20~55 600FHM20~55	
70SHA20~30 660GA-20~30	
70SHA35~55 660GA-35~55	
70SHA60~75 660GA-60~75 700FHS50~75	
66LKA20~100	35
1000GH-16~80 100SHA16~50	55

Instructions for Micro-switch installation

Before using, please read these instructions carefully and use the device in the appropriate manner.

Micro-switch : AMS series

Fuse with an indicator fuse : Products that have "S" after the rated amperage in the product number

1. Hold the indicator fuse firmly and put in the micro-switch

If the micro-switch is installed without holding the indicator fuse, this may cause the indicator band to bend and/or come out of the indicator fuse easily.

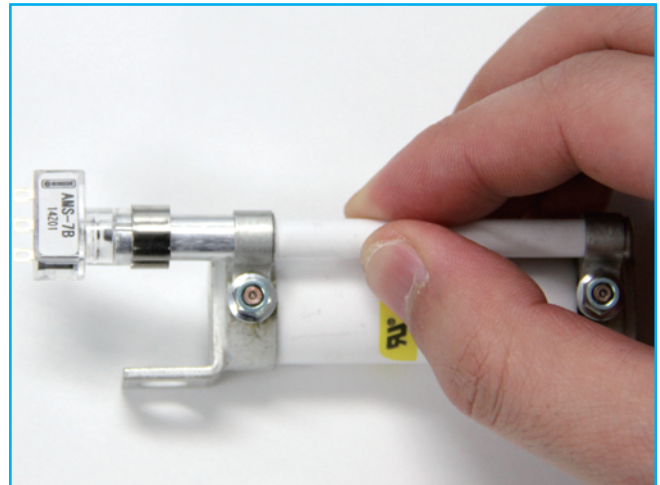

Hold the indicator fuse with your fingers firmly.

2. Twist lightly and install the micro-switch to the prescriptive location

If the micro-switch is installed forcibly and at an irregular angle, this may cause the indicator band to bend and/or come out of the indicator fuse easily.

If it is not installed in the prescribed location, the fusing stick may not be able to reach the switch.

* In order to prevent disconnection, a ring is attached to the connecting part of the micro-switch. Depending on the ring size, a little insertion force may be required.

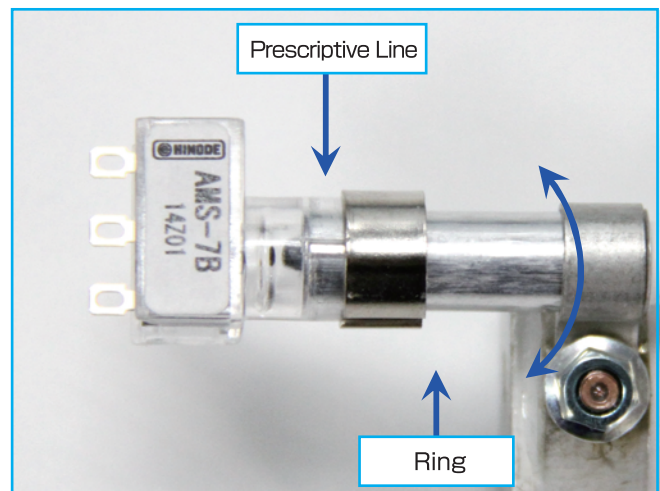

Table of UL certified products

UL File No.E143197

Model			Rated voltage and blocking capacity**	Rated Amperage(A)
●500VSK/500VSH Series				
500VSH10	500VSK10		AC450V-10kA DC450V(L/R1ms)-10kA	10
500VSH20	500VSK20			20
500VSH36	500VSK36			36
●500SF/500SFK Series				
250SF-4UL	250SFK04UL		A250V-10kA DC250V(L/R10ms)-10kA	4
250SF-6UL	250SFK06UL			6
250SF-10UL	250SFK10UL			10
250SF-16UL	250SFK16UL			16
●500SF/500SFK Series				
500SF-4UL	500SFK04UL		A500V-10kA DC500V(L/R2ms)-10kA	4
500SF-6UL	500SFK06UL			6
500SF-10UL	500SFK10UL			10
500SF-16UL	500SFK16UL			16
500SF-20UL	500SFK20UL			20
●400KH/400KHK Series				
400KH-5UL	400KHK05UL		AC400V-10kA DC400V(L/R5ms)-10kA	5
400KH-10UL	400KHK10UL			10
400KH-15UL	400KHK15UL			15
400KH-20UL	400KHK20UL			20
400KH-25UL	400KHK25UL			25
400KH-30UL	400KHK30UL			30
400KH-35UL	400KHK35UL		AC400V-10kA DC400V(L/R2ms)-10kA	35
400KH-40UL	400KHK40UL			40
400KH-50UL	400KHK50UL			50
400KH-60UL	400KHK60UL			60
●660CF/660KH/660KHK Series				
660CF-5UL	660KH-5UL	660KHK05UL	AC660V-10kA DC570V(L/R2ms)-10kA	5
660CF-10UL	660KH-10UL	660KHK10UL		10
660CF-15UL	660KH-15UL	660KHK15UL		15
660CF-20UL	660KH-20UL	660KHK20UL		20
660CF-25UL	660KH-25UL	660KHK25UL		25
660CF-30UL	660KH-30UL	660KHK30UL		30
660CF-35UL	660KH-35UL	660KHK35UL		35
660CF-40UL	660KH-40UL	660KHK40UL		40
660CF-50UL	660KH-50UL	660KHK50UL		50
660CF-60UL	660KH-60UL	660KHK60UL		60
●800CF Series				
800CF-5UL			AC660V-10kA DC800V(L/R10ms)-10kA	5
800CF-10UL				10
800CF-15UL				15
800CF-20UL				20
800CF-25UL				25
800CF-30UL				30
●350GH Series				
350GH-16UL	350GH-16SUL		AC380V-10kA DC400V(L/R2ms)-10kA	16
350GH-20UL	350GH-20SUL			20
350GH-25UL	350GH-25SUL			25
350GH-32UL	350GH-32SUL			32
350GH-40UL	350GH-40SUL			40
350GH-50UL	350GH-50SUL	350GHK050UL		50
350GH-63UL	350GH-63SUL			63
350GH-80UL	350GH-80SUL	350GHK080UL		80
350GH-100UL	350GH-100SUL	350GHK100UL		100
350GH-125UL	350GH-125SUL			125
350GH-160UL	350GH-160SUL			160
350GH-200UL	350GH-200SUL			200
350GH-250UL	350GH-250SUL			250
350GH-315UL	350GH-315SUL			315

Model			Rated voltage and blocking capacity※	Rated Amperage (A)
●660GH Series				
660GH-16UL	660GH-16SUL		AC660V-10kA DC660V(L/R10ms)-10kA	16
660GH-20UL	660GH-20SUL			20
660GH-25UL	660GH-25SUL			25
660GH-32UL	660GH-32SUL			32
660GH-40UL	660GH-40SUL			40
660GH-50UL	660GH-50SUL			50
660GH-63UL	660GH-63SUL			63
660GH-80UL	660GH-80SUL			80
660GH-100UL	660GH-100SUL			100
660GH-125UL	660GH-125SUL			125
660GH-160UL	660GH-160SUL			160
660GH-200UL	660GH-200SUL			200
660GH-250UL	660GH-250SUL			250
660GH-315UL	660GH-315SUL			315
●750GH/GHK				
750GH-50UL	750GH-50SUL	750GHK050ULTC	AC850V-10kA DC750V(L/R2ms)-10kA	50
750GH-63UL	750GH-63SUL			63
750GH-75UL	750GH-75SUL			75
750GH-80UL	750GH-80SUL	750GHK080ULTC		80
750GH-100UL	750GH-100SUL	750GHK100ULTC		100
750GH-125UL	750GH-125SUL			125
750GH-160UL	750GH-160SUL			160
750GH-200UL	750GH-200SUL			200
●1000GH Series				
1000GH-16UL	1000GH-16SUL		AC1000V-100kA DC1000V(L/R3ms)-100kA	16
1000GH-20UL	1000GH-20SUL			20
1000GH-25UL	1000GH-25SUL			25
1000GH-32UL	1000GH-32SUL			32
1000GH-40UL	1000GH-40SUL			40
1000GH-50UL	1000GH-50SUL			50
1000GH-63UL	1000GH-63SUL			63
1000GH-80UL	1000GH-80SUL			80
1000GH-100UL	1000GH-100SUL			100
1000GH-125UL	1000GH-125SUL			125
1000GH-160UL	1000GH-160SUL			160
1000GH-200UL	1000GH-200SUL			200
1000GH-250UL	1000GH-250SUL			250
1000GH-315UL	1000GH-315SUL			315
1000GH-400UL	1000GH-400SUL			400
1000GH-500UL	1000GH-500SUL			500
1000GH-630UL	1000GH-630SUL		630	
●600SPF Series				
600SPF100SUL			AC600V-100kA DC450V(L/R3ms)-100kA	100
600SPF125SUL				125
600SPF160SUL				160
600SPF200SUL				200
600SPF250SUL				250
600SPF315SUL				315
600SPF350SUL				350
600SPF400SUL				400
600SPF500SUL				500
600SPF600SUL				600
600SPF630SUL				630
600SPF700SUL				700

Model	Rated voltage and blocking capacity※		Rated Amperage (A)
●600SPF Series			
600SPF800SUL		AC600V-100kA DC450V(L/R3ms)-100kA	800
600SPF900SUL			900
600SPF1000SUL			1000
●1000SPF Series			
1000SPF100SUL		AC1000V-100kA DC800V(L/R10ms)-100kA	100
1000SPF125SUL			125
1000SPF160SUL			160
1000SPF200SUL			200
1000SPF250SUL			250
1000SPF315SUL			315
1000SPF350SUL			350
1000SPF400SUL			400
1000SPF500SUL			500
1000SPF630SUL			630
1000SPF700SUL			700
1000SPF800SUL			800

Table of CCC certified products / Table of TUV

Table of CCC certified products

Model			Rated voltage and blocking capacity	Rated Amperage(A)	Certification No
●500VSK/500VSH Series					
500VSH10	500VSK10		AC400V-10kA DC350V(L/R15ms)-10kA	10	2014010308705170
500VSH20	500VSK20			20	
500VSH36	500VSK36			36	
●500SF/500SFK Series					
500SF-4ULTC	500SFK04ULTC		AC500V-50kA DC350V(L/R15ms)-50kA	4	2011010308492070
500SF-6ULTC	500SFK06ULTC			6	
500SF-10ULTC	500SFK10ULTC			10	
500SF-16ULTC	500SFK16ULTC			16	
500SF-20ULTC	500SFK20ULTC			20	
●400KH/400KHK Series					
400KH-5ULTC	400KHK05ULTC		AC400V-50kA DC250V(L/R15ms)-50kA	5	2011010308492070
400KH-10ULTC	400KHK10ULTC			10	
400KH-15ULTC	400KHK15ULTC			15	
400KH-20ULTC	400KHK20ULTC			20	
400KH-25ULTC	400KHK25ULTC			25	
400KH-30ULTC	400KHK30ULTC			30	
400KH-35ULTC	400KHK35ULTC			35	
400KH-40ULTC	400KHK40ULTC			40	
400KH-50ULTC	400KHK50ULTC			50	
400KH-60ULTC	400KHK60ULTC			60	
●660CF/660KH/660KHK Series					
660CF-5ULTC	660KH-5ULTC	660KHK05ULTC	AC660V-10kA DC450V(L/R15ms)-10kA	5	2014010308689980
660CF-10ULTC	660KH-10ULTC	660KHK10ULTC		10	
660CF-15ULTC	660KH-15ULTC	660KHK15ULTC		15	
660CF-20ULTC	660KH-20ULTC	660KHK20ULTC		20	
660CF-25ULTC	660KH-25ULTC	660KHK25ULTC		25	
660CF-30ULTC	660KH-30ULTC	660KHK30ULTC		30	
660CF-35ULTC	660KH-35ULTC	660KHK35ULTC		35	
660CF-40ULTC	660KH-40ULTC	660KHK40ULTC		40	
660CF-50ULTC	660KH-50ULTC	660KHK50ULTC		50	
660CF-60ULTC	660KH-60ULTC	660KHK60ULTC		60	
●350GH Series					
350GH-16ULTC	350GH-16SULTC		AC350V-50kA DC250V(L/R15ms)-50kA	16	20140101308676000
350GH-20ULTC	350GH-20SULTC			20	
350GH-25ULTC	350GH-25SULTC			25	
350GH-32ULTC	350GH-32SULTC			32	
350GH-40ULTC	350GH-40SULTC			40	
350GH-50ULTC	350GH-50SULTC	350GHK050ULTC		50	
350GH-63ULTC	350GH-63SULTC			63	
350GH-80ULTC	350GH-80SULTC	350GHK080ULTC		80	
350GH-100ULTC	350GH-100SULTC	350GHK100ULTC		100	
350GH-125ULTC	350GH-125SULTC			125	
350GH-160ULTC	350GH-160SULTC			160	
350GH-200ULTC	350GH-200SULTC			200	
350GH-250ULTC	350GH-250SULTC			250	
350GH-315ULTC	350GH-315SULTC		315		

certified products

Table of CCC certified products

Model			Rated voltage and blocking capacity※	Rated Amperage(A)	Certification No
●660GH Series					
660GH-16ULTC	660GH-16SULTC		AC660V-50kA DC450V(L/R15ms)-50kA	16	2014010308688460
660GH-20ULTC	660GH-20SULTC			20	
660GH-25ULTC	660GH-25SULTC			25	
660GH-32ULTC	660GH-32SULTC			32	
660GH-40ULTC	660GH-40SULTC			40	
660GH-50ULTC	660GH-50SULTC			50	
660GH-63ULTC	660GH-63SULTC			63	
660GH-80ULTC	660GH-80SULTC			80	
660GH-100ULTC	660GH-100SULTC			100	
660GH-125ULTC	660GH-125SULTC			125	
660GH-160ULTC	660GH-160SULTC			160	
660GH-200ULTC	660GH-200SULTC			200	
660GH-250ULTC	660GH-250SULTC			250	
660GH-315ULTC	660GH-315SULTC			315	
●750GH/GHK					
750GH-50ULTC	750GH-50SULTC	750GHK050ULTC	AC800V-50kA DC600V(L/R10ms)-50kA	50	2012010308547260
750GH-63ULTC	750GH-63SULTC			63	
750GH-75ULTC	750GH-75SULTC			75	
750GH-80ULTC	750GH-80SULTC	750GHK080ULTC		80	
750GH-100ULTC	750GH-100SULTC	750GHK100ULTC		100	
750GH-125ULTC	750GH-125SULTC			125	
750GH-160ULTC	750GH-160SULTC			160	
750GH-200ULTC	750GH-200SULTC			200	

Table of TUV certified products

Model			Rated voltage and blocking capacity※	Rated Amperage(A)	Certification No
●25LK Series					
25LKA20B			AC250V-10kA DC350V(L/R10ms)-10kA	20	J50165367
25LKA30B				30	
25LKA50B				50	
25LKA75B				75	
25LKA100B				100	
25LKB100B				100	
25LKB150B				150	
25LKB200B				200	
25LKB260B				260	
25LKB300B				300	
25LKB350B				350	

500SFK series fuse board mounting design data

1. Recommended mounting hole pitch

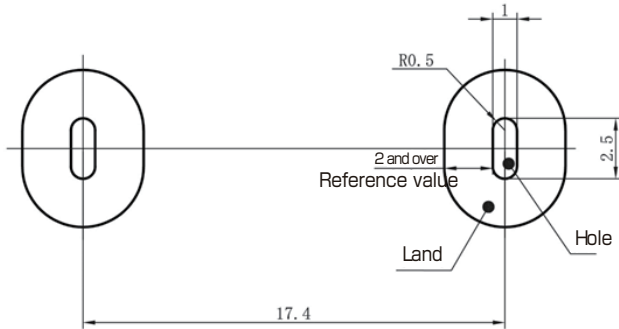

2. Fuse temperature increase

The fuse temperature depends on substrate pattern and current flow, etc.
 Our substrate fuse temperature increase characteristics are according to a copper layer width that gives 1A/mm (copper layer thickness 35 μ m) for a current of 50% rated current.

● Conditions

Board size : 150mm \times 100mm

Board material : FR-4

Copper layer thickness: 35 μ m

Measurement

● Temperature increase characteristics

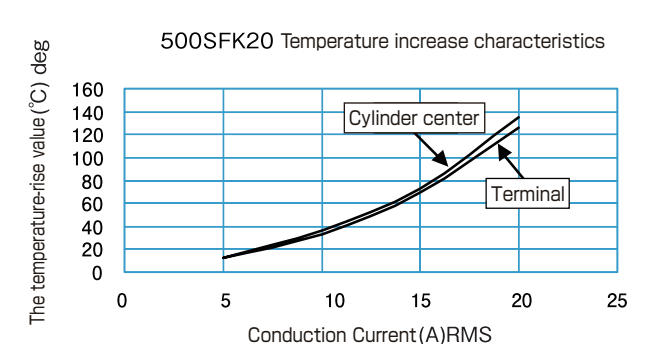
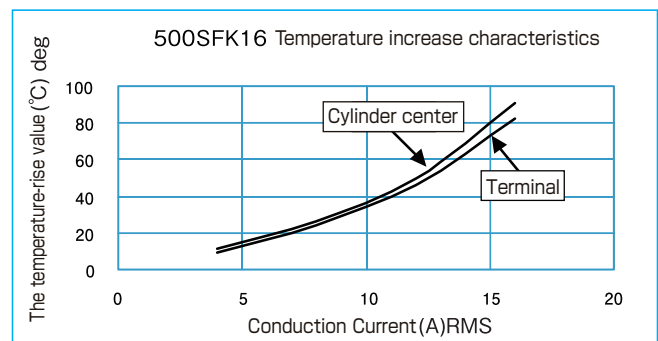
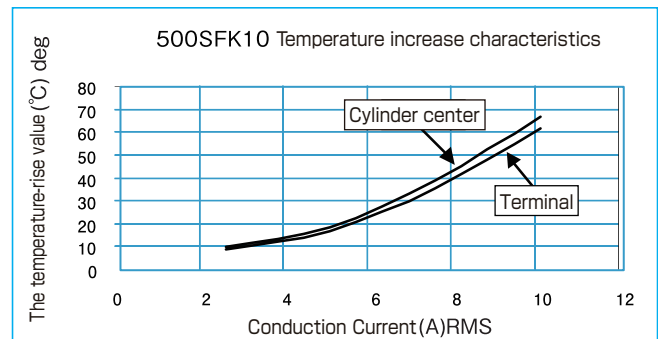
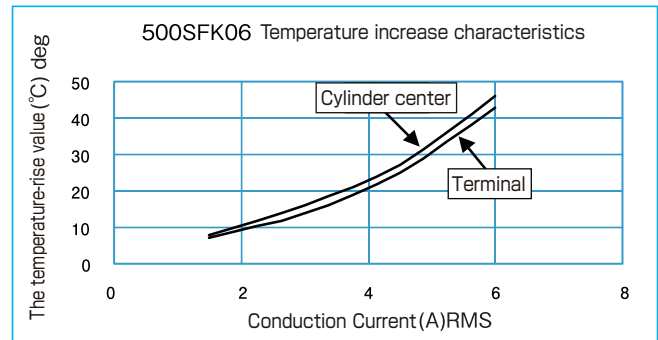
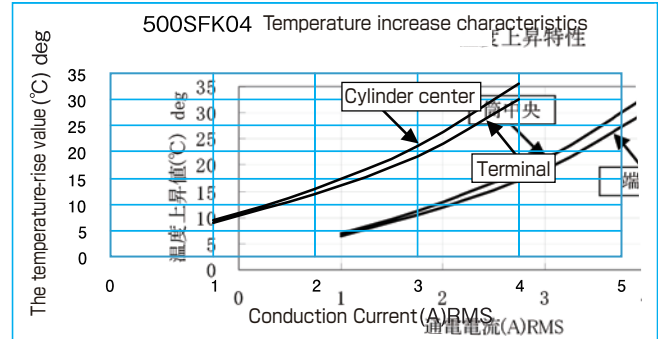

KHK series fuse board mounting design data

1. Recommended mounting hole pitch

●660KHK Series

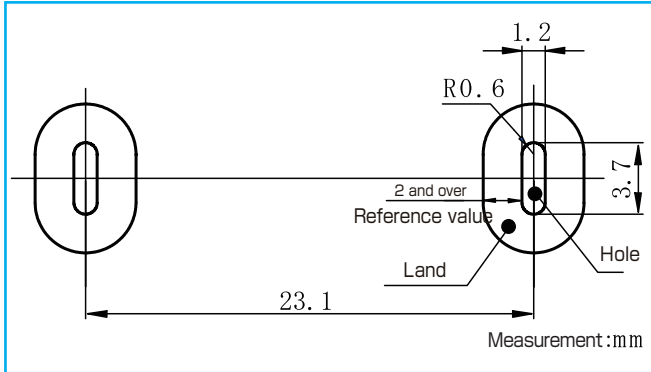

●400KHK Series

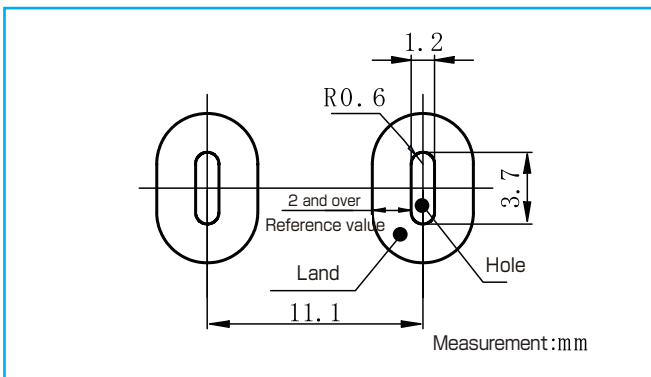

2. Creepage distance, air clearance

A large voltage is applied between both terminals during fuse cut-off.

Recommended values for land separation and distances from other components are given in the table below.

Series	Antithetic pattern·distance		Antithetic fuse-component separation
	Coated substrate	Uncoated substrate	
400KHK	3mm and over	5mm and over	4mm and over
660KHK	5mm and over	8mm and over	6mm and over

There is the potential for substrate contamination to decrease insulation on the 400KHK. In the event a large fuse terminal separation is necessary or terminal separation is insufficient according your regulations please use the 660KHK.

3. Fuse temperature increase

The fuse temperature depends on substrate pattern and current flow, etc.

Our substrate fuse temperature increase characteristics are according to a copper layer width that gives 1A/mm (coper layer thickness 35 μ m) for a current of 50% rated current.

● Conditions

Board size : 150mm \times 100mm

Board material : FR-4

Copper layer thickness : 35 μ m

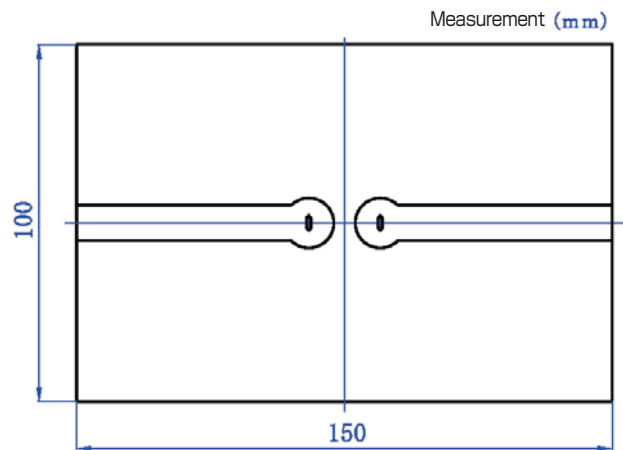

●400KHK (350KHK) Temperature increase characteristics

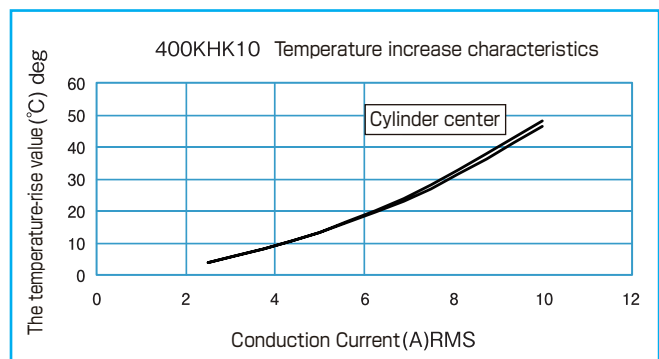
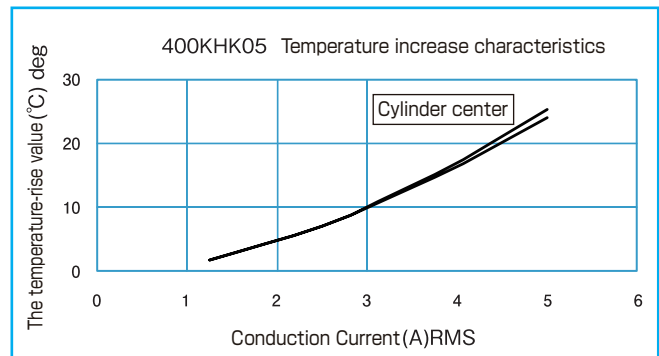

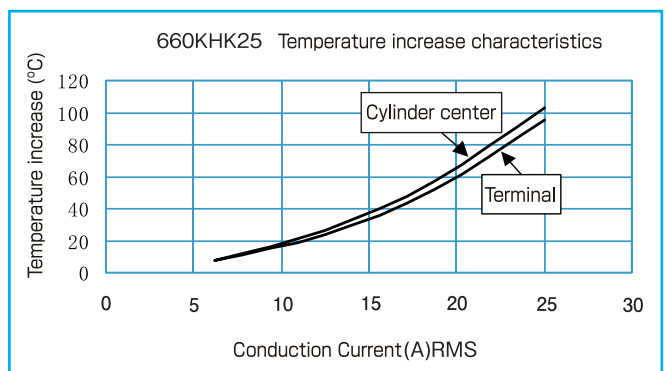
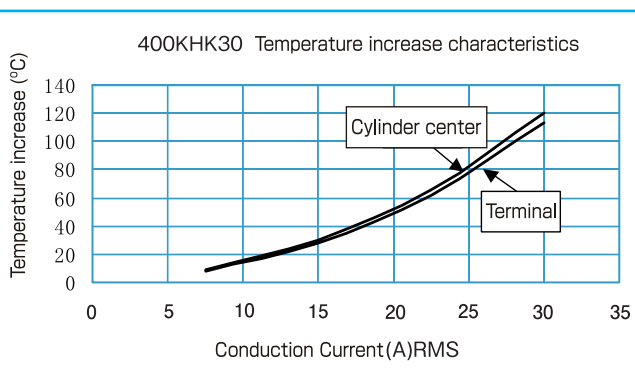
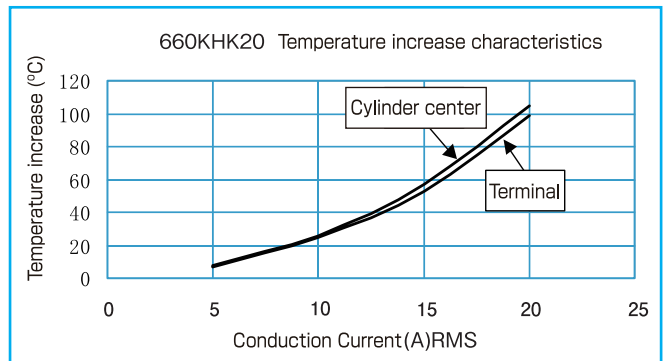
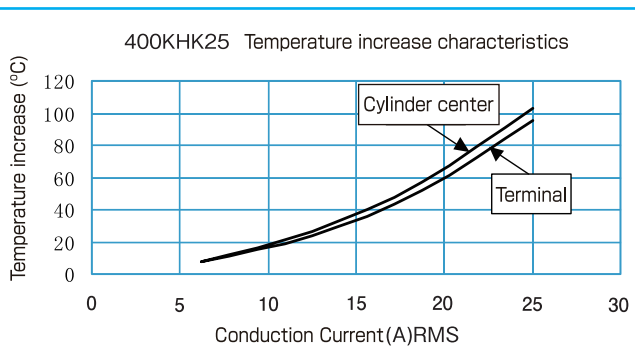
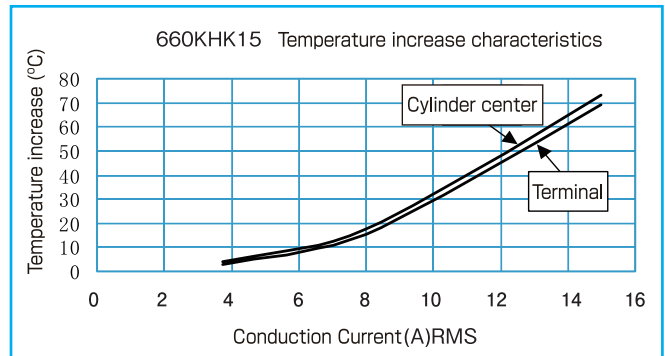
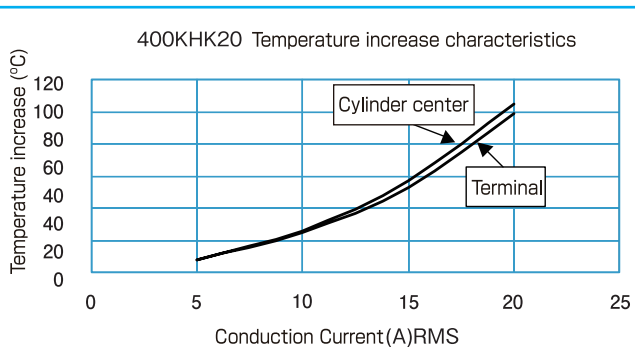
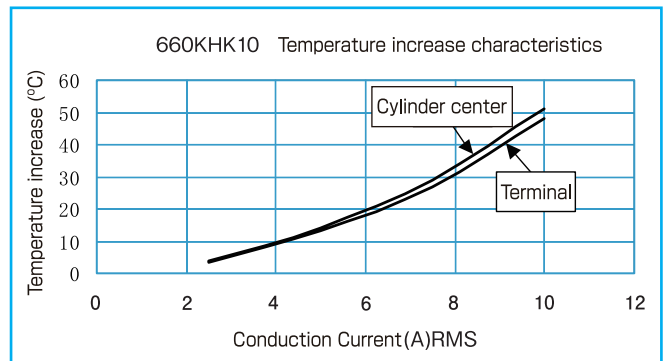
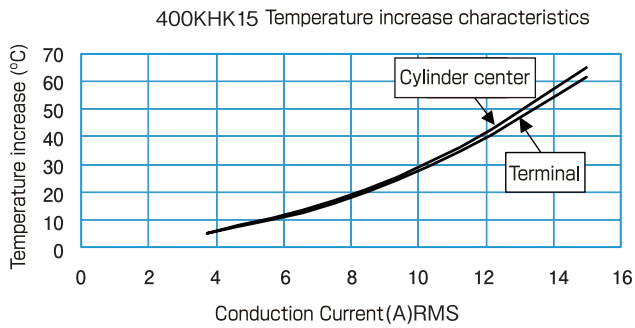

Temperature increase characteristics

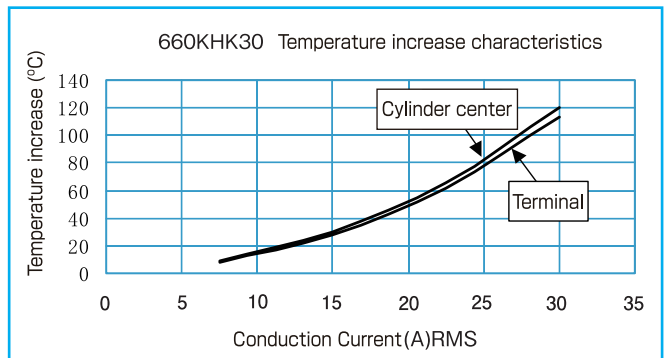
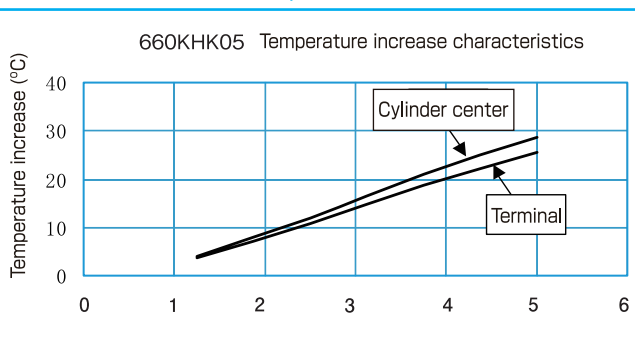

GHK series fuse board mounting design data

1. Recommended mounting hole pitch/recommended land

● 750GHK Series

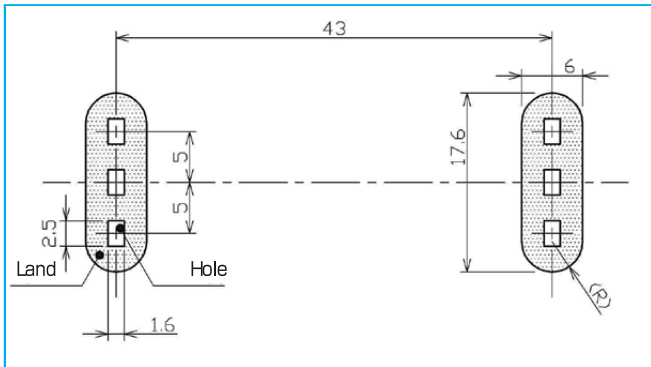

● 350GHK Series

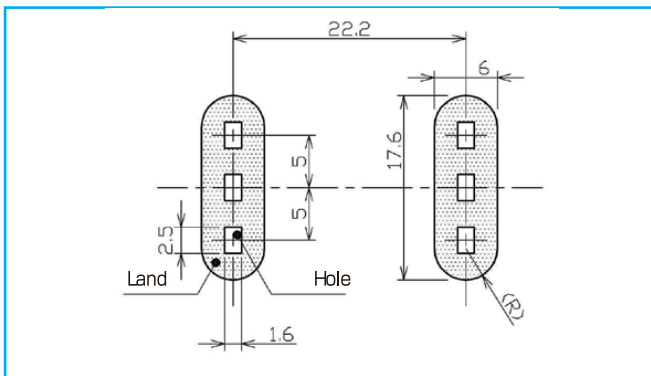

2. Creepage distance, air clearance

A large voltage is applied between both terminals during fuse cut-off.

Recommended values for land separation and distances from other components are given in the table below.

Series	Land separation between terminals		Fuse-component separation
	Coated substrate	Uncoated substrate	
350GHK	3mm or higher	5mm or higher	4mm or higher
750GHK	5mm or higher	8mm or higher	6mm or higher

3. Fuse temperature increase

The fuse temperature depends on substrate pattern and current flow, etc. Our substrate fuse temperature increase characteristics are according to a copper layer width that gives 1A/mm (copper layer thickness 35μm) for a current of 50% rated current.

E.g. In the case of a 100A rated fuse, the test is with a pattern of a 50 mm copper layer width.

● Test substrate

Board size : 150mm×100mm

Board material : FR-4

Copper layer thickness : 35μm

Copper layer width : Depends on rated current

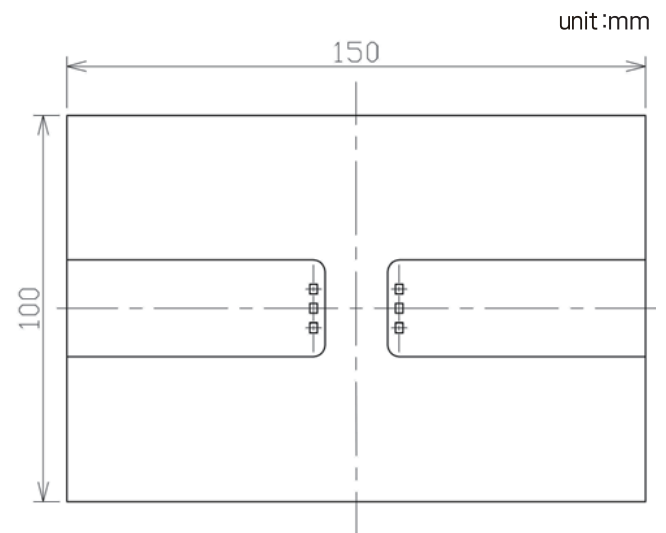

Substrate-mounted fuse temperature profile for flow soldering method

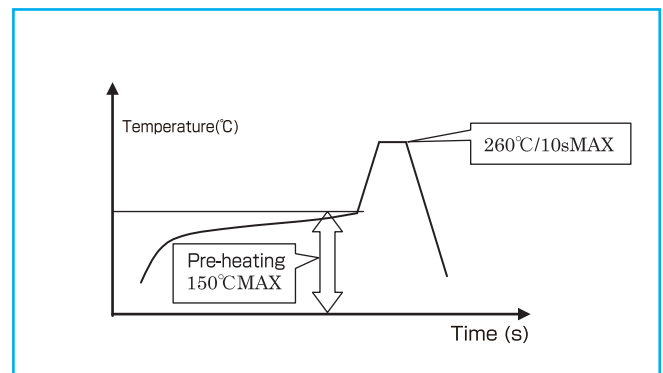

PROTECT FUSE USER'S GUIDE

Where in the circuit should I use a fuse?

First, consider what you would like to protect with the fuse.
Examples of applying position on the inverter circuit

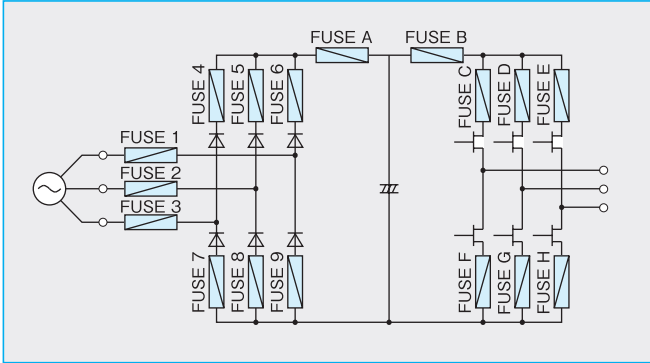

To prevent secondary damage to supplied power

- To protect from condenser short circuit or IGBT short circuit ... Applicable to FUSE A
- To cope with accidents from condenser short circuit, IGBT short circuit, and diode short circuit ... Applicable to FUSE 1 and 3.
- To cope with condenser short circuit, IGBT short circuit, diode short circuit, earth short circuit ... Applicable to FUSE 1, 2, and 3, and also to FUSE 4, 5, 6, 7, 8, and 9.

To prevent diode chips from being damaged

- If you would like to prevent explosion or ignition of chips with fewer fuses:
 - To prevent damage to a chip by adverse DC current ... Applicable to FUSE A.
 - To prevent damage to a chip by supplied power current ... Applicable to FUSE 1 and 3.
 - To prevent both of the above ... Applicable to FUSE A, 1, and 3.
- To prevent damage to a chip by adverse DC current ... Applicable to FUSE A.
- If you would like to reuse sound chips as well as to prevent explosion or ignition of chips ... Applicable to FUSE 4, 5, 6, 7, 8, and 9.

To prevent explosion and short-circuit mode of IGBT or thyristor chips

- If you would like to protect with fewer fuses ... Applicable to FUSE B.
- If you would like to reuse sound chips (only for thyristors) ... Applicable to FUSE C, D, E, F, G, and H.

For devices from a few kilowatts to tens of kilowatts, fuses are often applied to FUSE 1, 3, and A.

How to select a fuse

Main factors in selection

- Working voltage (AC or DC)
- Normal electric current
- Inrush current
- Ambient temperature
- Breaking current (maximum breaking current and minimum breaking current)
- Durability performance
- Installation structure

Select an appropriate fuse taking these factors into consideration.

Working voltage

Set the rated voltage of the fuse over the voltage of the circuit where the fuse is to be inserted.

Normal electric current

To avoid unnecessary fusing, lower the load factor of the normal electric current according to the rated amperage of the fuse. The main load factors used for our products are as follows:

*The load factor is at the ambient temperature of 25°C.

Model	Load Factor	Constant current and alternating sine wave current	Pulse wave form of inverters / power regulators
250SF/SFK	60% or less	60% or less	50% or less
500SF/SFK			
660CF/KH/KHK	50% or less	50% or less	40% or less
400KH/KHK			
250GH/350GH 660GH	70% or less	70% or less	60% or less
600SPF 1000SPF			
1000GH	60% or less	60% or less	50% or less
1500SPF			

Inrush current (when considering fusing I²t)

The fusing I²t indicated in this catalog is the energy of the fused electric current in time when the heat that occurred does not radiate from the inner conductor by heat conduction. The fusing I²t varies according to fuse types.

The fusing I²t has to be considered if the Inrush current (surge electric current, start electric current, plunge electric current, and so on) occurs. If the I²t of the Inrush current is higher than the fuse I²t, it will cause unnecessary fusing. By setting the I²t of Inrush current to less than 25% of the fuse's I²t, the fuse will withstand the repetitive Inrush current over 30,000 times.

Ambient temperature

The fuse characteristics described above assume an ambient temperature of 25°C. At a higher ambient temperature, the fuse works in a hotter state, and therefore its life will be shorter. If the ambient temperature is high, reduce the load factor. (Refer to chart titled "reduction rate by the ambient temperature.")

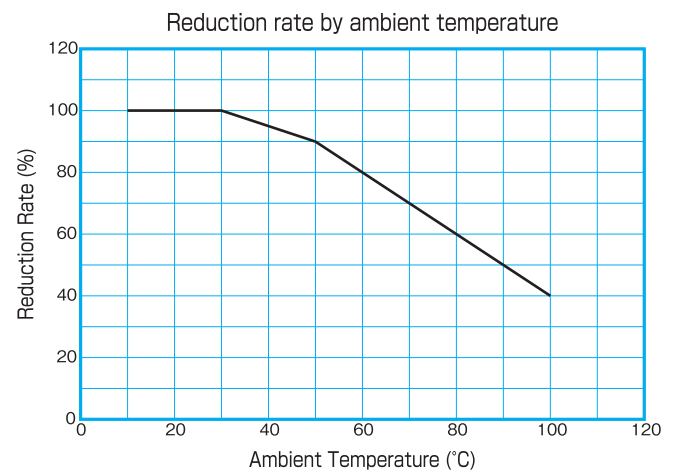

Breaking current

Maximum breaking current

Assume that the current breaking capacity of the fuse is greater than the maximum broken current of the circuit.

Minimum breaking current

Use the fuse with other protection equipment as there may be a possibility of a restrike arc after fusing if an accidental current in the circuit is below the minimum breaking current.

Circuit time constant

When using for a direct-current circuit, use it under the time constant prescribed by the breaking capacity (or reduce the voltage by its circuit time constant).

FOR SAFE USE / PRODUCT WARRANTY

FOR SAFE USE



CAUTION!

- Installation/removal, wiring work, maintenance, and inspection must be done by an expert.
- Do not use under an abnormal environment such as a place with high temperature and/or high humidity, a dusty place, a place filled with corrosive gas, or a place that may be subject to physical vibrations and/or shock.
- Do not expose to any liquids.
- Make sure that the terminal is securely tightened. Using a loose terminal may cause a fire.
- Use a wire suitable for the working voltage and the conduction current. When it is used with incomplete wiring, it may cause a fire.
- Do not dismantle or remodel the product.
- Do not use the fuse if you find any damage or alterations while unpacking.
- Use below the rated voltage of the fuse. If exceeded, a burnout or an explosion may occur.
- Use the fuse such that its current breaking capacity is not exceeded. If exceeded, a burnout or an explosion may occur.
- When using for the following equipment or purposes, consult our business desk and finalize specifications for delivery. Safety and security in design and use are the user's responsibility.
 - Use on equipment or for a purpose that may directly result in injury or death such as medical equipment.
 - Use on a train, an elevator, and so on that may endanger human lives.
 - Use on equipment or use for purposes that may involve a shock or a vibration, such as when loading on a vehicle or a ship.
 - Use on equipment or for purposes that may have a serious effect on society and/or public (e.g., in a traffic system).
 - Use on equipment or use for purposes related to the above.



WARNING

- When using the fuse for a direct-current circuit, use it at a value lower than the time constant corresponding to the breaking capacity (or reduce the voltage by varying the circuit time constant). It may cause a burnout or an explosion if the time constant of the fuse is exceeded.
- When there is a possibility of block-off below the minimum breaking current, take measures such as using other means of protection in addition to the fuse. When no measures are taken, it may cause a burnout or an explosion.
- When the fuse blocks off, the welding arc voltage occurs between the fuse poles, so be sufficiently careful about arrangement of parts around the fuse.
- A fuse protecting a semiconductor becomes hotter than other general parts even under normal conditions. Touching the fuse may cause burns when the equipment is turned on or after an accidental block-off; attach a label to call attention to the high temperature near the fuse installed on the equipment.



DANGER

- Be careful not to touch a fuse by hand when an electric current is flowing; it may cause an electric shock. When installing the product on equipment, make sure that a shock-guard protector is attached to the fuse or a label is put nearby to indicate the danger of electric shock.

PRODUCT WARRANTY

Period of Warranty

The period of warranty is one year from the date of delivery.

Scope of Warranty

We will re-deliver the same product or a substitute product promptly in case a product defect causes an inconvenience during the above warranty period. However, the following exceptions apply:

1. When the inconvenience is due to the customer's decision when adopting the product.
2. When an inconvenience occurred that could not be predicted in a performed evaluation test.
3. When the product was exposed to physical, chemical, and/or electrical-engineering-related stress without the manufacturer's consent.
4. When it was difficult to perceive the concerned defect with the level of science and technologies of both the manufacturer and the customer at the time of the product delivery.
5. When the defect is based on directions of the customer who was engaged in its design.
6. When the malfunction is due to a reason not deriving from the supplied products.
7. When the product defects are due to remodeling by someone other than the manufacturer, or when the product defects are caused by violating conditions about the specifications and/or storage that are determined by the manufacturer.
8. When the supplied product is used, without the manufacturer's prior consent, in situations in which the product defects could harm human lives or cause great physical damage to occur.

Notice about the Warranty

1. Note that compensations are made through the delivery of a replacement or substitute in all cases.
2. When using our fuse for a market where high reliability and safety are required, take precautions in the design of, and security measures for, the applicable device at your own responsibility.
3. If a malfunction or a breakdown of unknown origin causing fusing occurs remove the fuse as-is and return it to our office.
4. For the AMS series, the warranty is also in accordance with the warranty conditions of the microswitch manufacturer as well as those mentioned above. Refer to the warranty of the microswitch manufacturer.

Note that the descriptions in this catalog are subject to change without notice for product improvements or for other reasons.

Company Profile

Commercial Name	Hinode Electric Co., Ltd.
Founded	October 3, 1955
President	Kazuhiro Hirahara
Location	1-18-9 Hokima, Adachi-ku, Tokyo 121-0064, JAPAN
URL	http://www.hinodedenki.co.jp/e.php
E-mail address	int@hinodedenki.co.jp
Employees	100
Certification	ISO9001, ISO14001, UL, CCC, TUV ROHS Compliant (Some exceptions)
Factory dimensions	460m ² 6 floor's 1,000m ²
Product items	<ul style="list-style-type: none">· Fast acting fuses and order made fuses· The development of the above mentioned products
Member of	Nihon Fuse Industrial Association



HINODE Founded in 1946

HINODE ELECTRIC CO.,LTD.

1-18-9 Hokima, Adachi-ku, Tokyo 121-0064, JAPAN
URL:<http://www.hinodedenki.co.jp>

*The specifications are subject to change without notice for product improvements.

Agency