

# SKKD 42F, SKMD 42F, SKND 42F

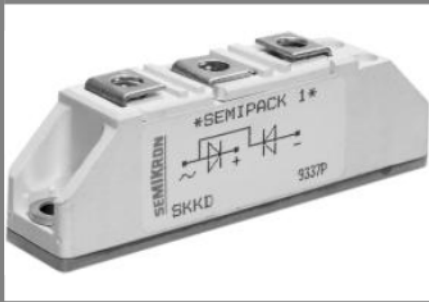

**SEMIPACK® 1**

## Fast Diode Modules

SKKD 42F

SKMD 42F

SKND 42F

## Features

## Typical Applications

--	--	--	--	--

Symbol	Conditions	Values	Units

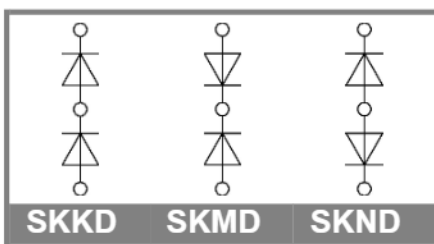

SKKD

SKMD

SKND

# SKKD 42F, SKMD 42F, SKND 42F

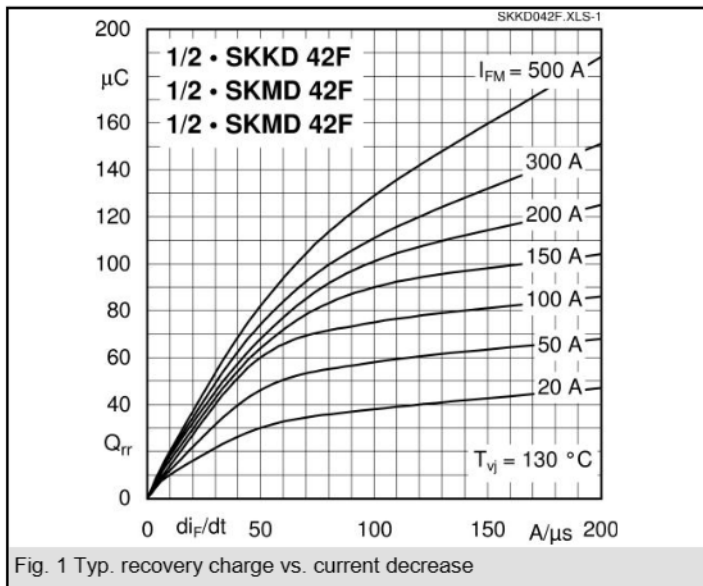

Fig. 1 Typ. recovery charge vs. current decrease

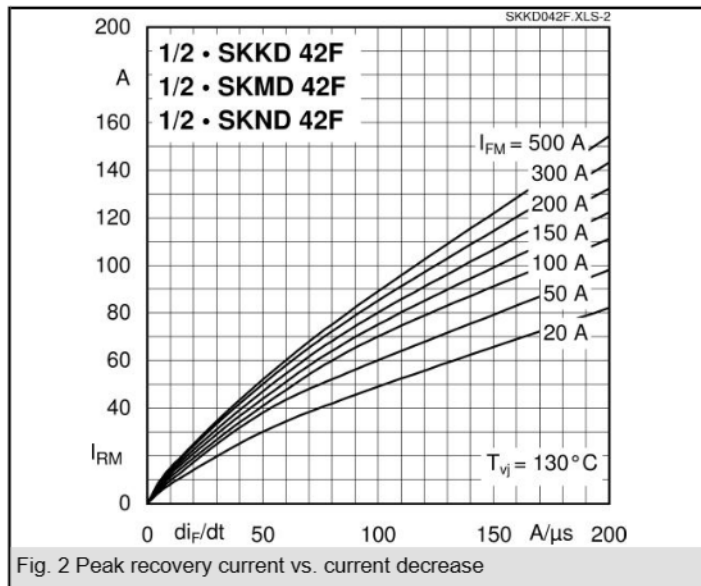

Fig. 2 Peak recovery current vs. current decrease

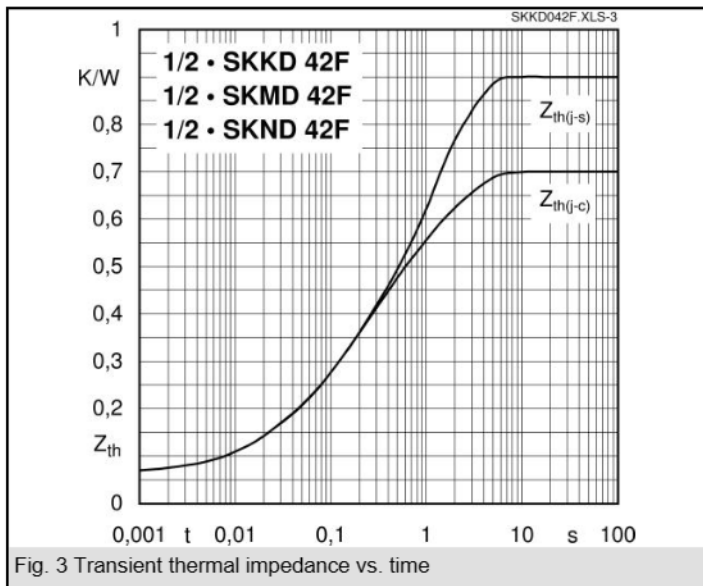

Fig. 3 Transient thermal impedance vs. time

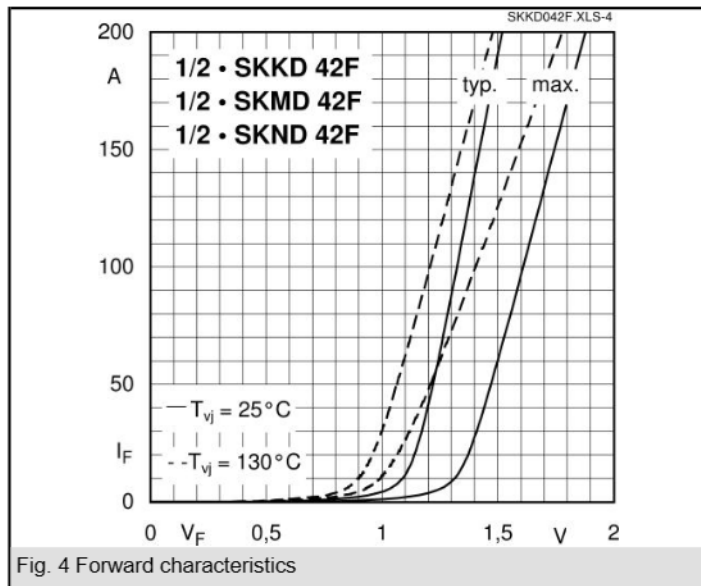

Fig. 4 Forward characteristics

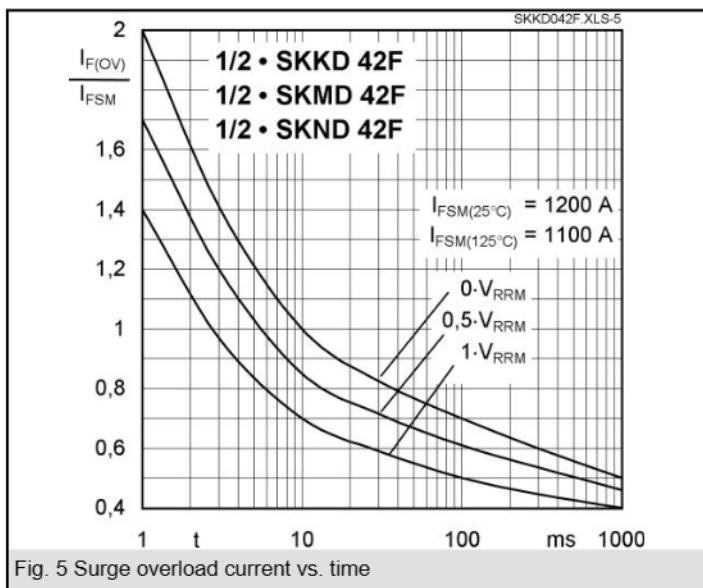
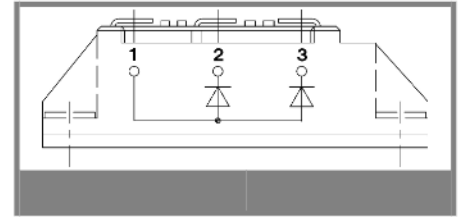
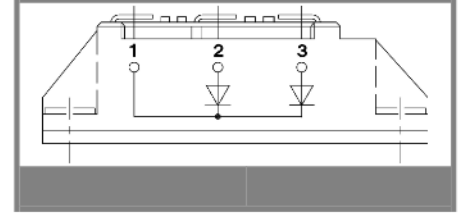
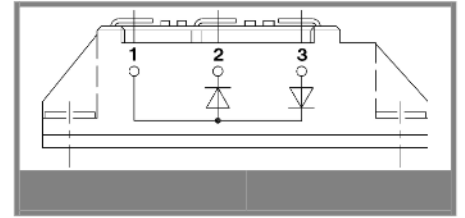
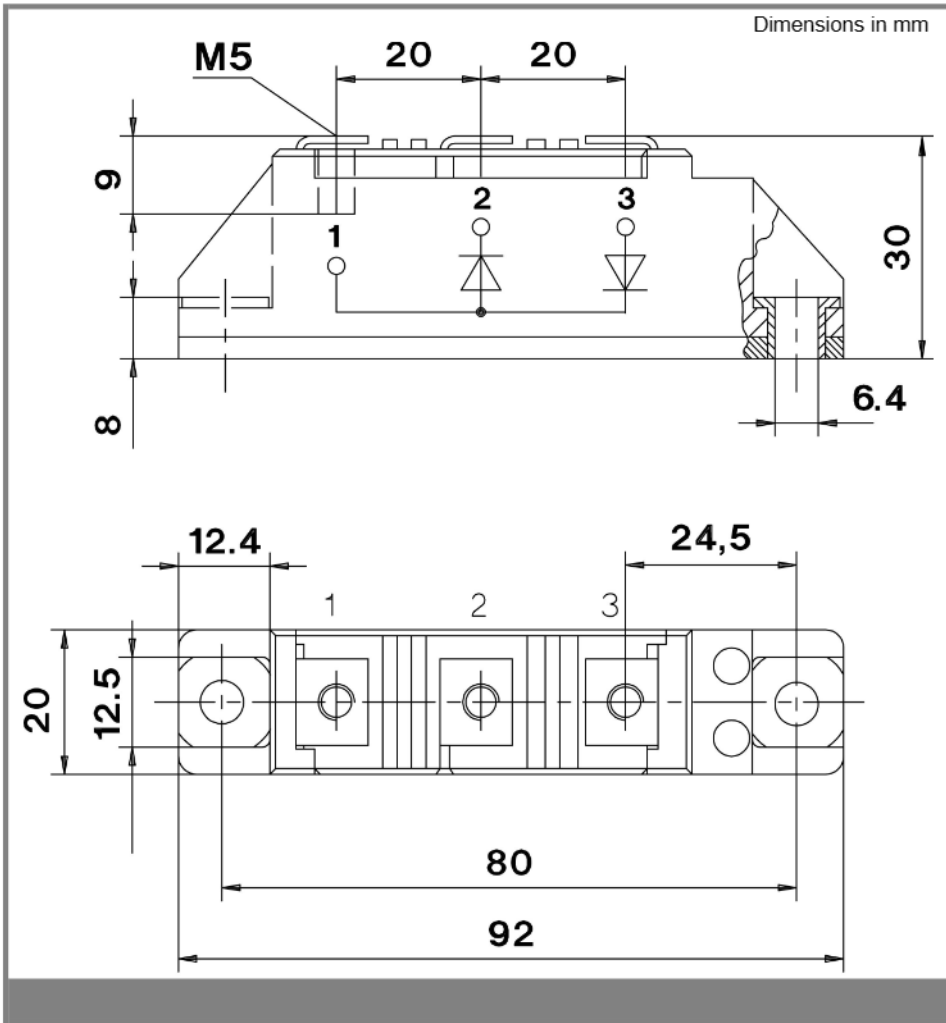

Fig. 5 Surge overload current vs. time

# SKKD 42F, SKMD 42F, SKND 42F



This technical information specifies semiconductor devices but promises no characteristics. No warranty or guarantee expressed or implied is made regarding delivery, performance or suitability.