

# SKT 24



## Stud Thyristor

## Line Thyristor

### SKT 24

### Features

- Hermetic metal case with glass insulator
- Threaded stud ISO M6 or UNF 1/4-28
- International standard case

### Typical Applications\*

- DC motor control (e. g. for machine tools)
- Controlled rectifiers (e. g. for battery charging)
- AC controllers (e. g. for temperature control)
- Recommended snubber network e. g. for  $V_{VRMS} \leq 400$  V:  
 $R = 100 \Omega / 5$  W,  $C = 0,1 \mu F$

1) Available with UNF thread 1/4-28 UNF2A, e. g. SKT 24/12E UNF

$V_{RSM}$ V	$V_{RRM}, V_{DRM}$ V	$I_{TRMS} = 50$ A (maximum value for continuous operation) $I_{TAV} = 24$ A (sin. 180; $T_c = 95$ °C)	
500	400	SKT 24/04D	
900	800	SKT 24/08D	
1300	1200	SKT 24/12E <sup>1)</sup>	
1500	1400	SKT 24/14E	
1700	1600	SKT 24/16E <sup>1)</sup>	
1900	1800	SKT 24/18E	

Symbol	Conditions	Values	Units
$I_{TAV}$	sin. 180; $T_c = 100$ (85) °C;	22 (29)	A
$I_D$	K5; $T_a = 45$ °C; B2 / B6 K3; $T_a = 45$ °C; B2 / B6	22 / 30 28 / 40	A A
$I_{RMS}$	K5; $T_a = 45$ °C; W1C	24	A
$I_{TSM}$	$T_{vj} = 25$ °C; 10 ms $T_{vj} = 130$ °C; 10 ms	450 380	A A
$i^2t$	$T_{vj} = 25$ °C; 8,35 ... 10 ms $T_{vj} = 130$ °C; 8,35 ... 10 ms	1000 720	A <sup>2</sup> s A <sup>2</sup> s
$V_T$	$T_{vj} = 25$ °C; $I_T = 75$ A	max. 1,9	V
$V_{T(TO)}$	$T_{vj} = 130$ °C	max. 1	V
$r_T$	$T_{vj} = 130$ °C	max. 10	mΩ
$I_{DD}, I_{RD}$	$T_{vj} = 130$ °C; $V_{RD} = V_{RRM}, V_{DD} = V_{DRM}$	max. 8	mA
$t_{gd}$	$T_{vj} = 25$ °C; $I_G = 1$ A; $di_G/dt = 1$ A/μs	1	μs
$t_{gr}$	$V_D = 0,67 * V_{DRM}$	2	μs
$(di/dt)_{cr}$	$T_{vj} = 130$ °C	max. 50	A/μs
$(dv/dt)_{cr}$	$T_{vj} = 130$ °C; SKT ...D / SKT ...E	max. 500 / 1000	V/μs
$t_q$	$T_{vj} = 130$ °C,	80	μs
$I_H$	$T_{vj} = 25$ °C; typ. / max.	80 / 150	mA
$I_L$	$T_{vj} = 25$ °C; typ. / max.	150 / 300	mA
$V_{GT}$	$T_{vj} = 25$ °C; d.c.	min. 3	V
$I_{GT}$	$T_{vj} = 25$ °C; d.c.	min. 100	mA
$V_{GD}$	$T_{vj} = 130$ °C; d.c.	max. 0,25	V
$I_{GD}$	$T_{vj} = 130$ °C; d.c.	max. 3	mA
$R_{th(j-c)}$	cont.	0,8	K/W
$R_{th(j-c)}$	sin. 180	0,9	K/W
$R_{th(j-c)}$	rec. 120	0,95	K/W
$R_{th(c-s)}$		0,5	K/W
$T_{vj}$		- 40 ... + 130	°C
$T_{stg}$		- 40 ... + 150	°C
$V_{isol}$		-	V~
$M_s$	to heatsink	2,5	Nm
$a$		5 * 9,81	m/s <sup>2</sup>
$m$	approx.	13	g
Case		B 2	



SKT

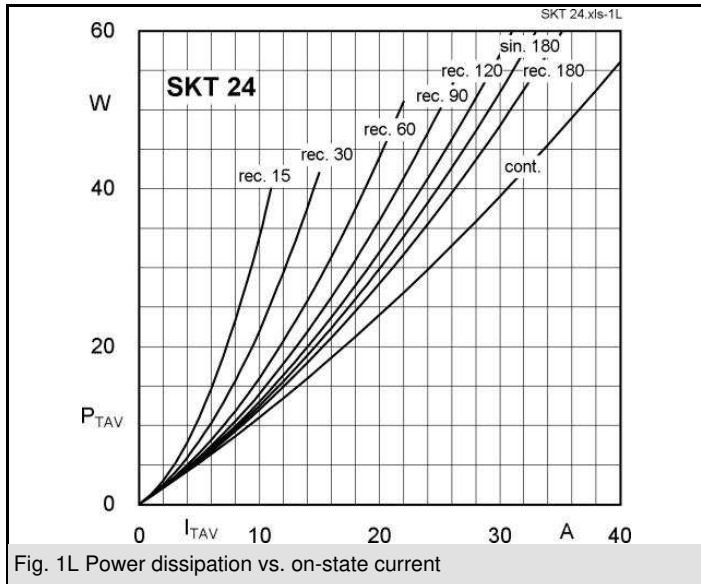

Fig. 1L Power dissipation vs. on-state current

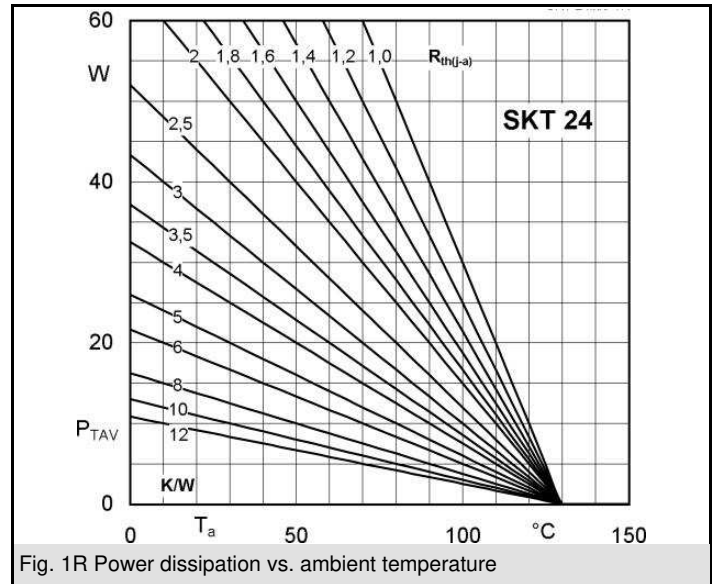

Fig. 1R Power dissipation vs. ambient temperature

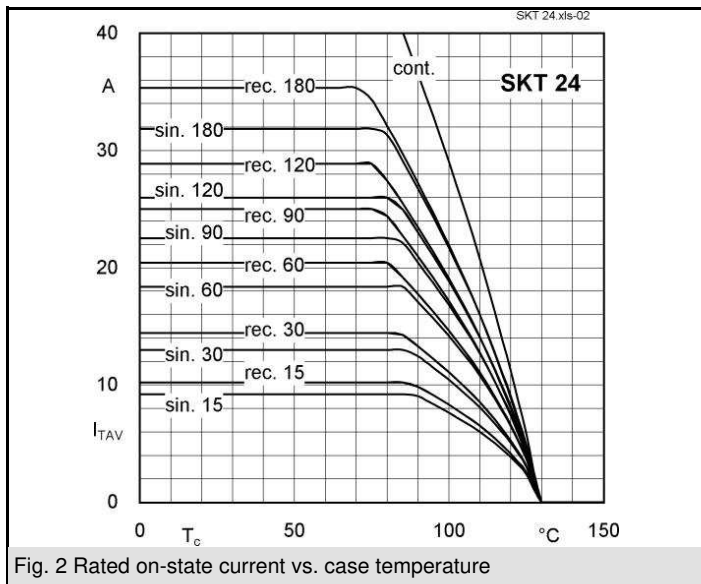

Fig. 2 Rated on-state current vs. case temperature

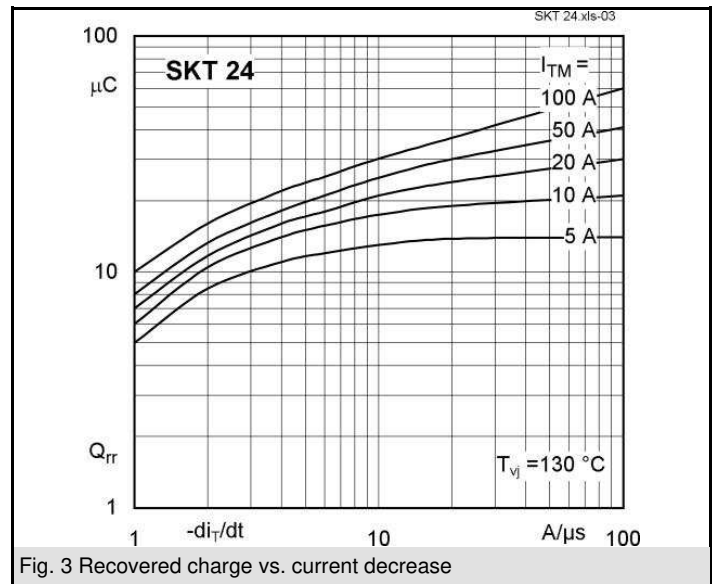

Fig. 3 Recovered charge vs. current decrease

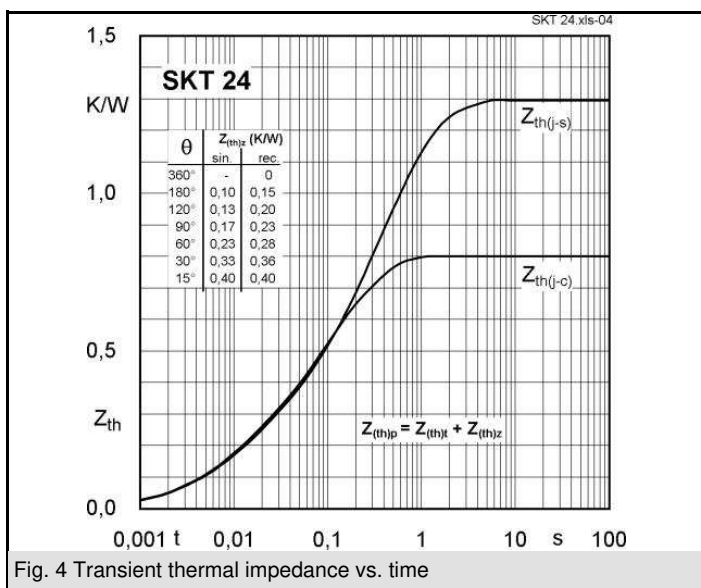

Fig. 4 Transient thermal impedance vs. time

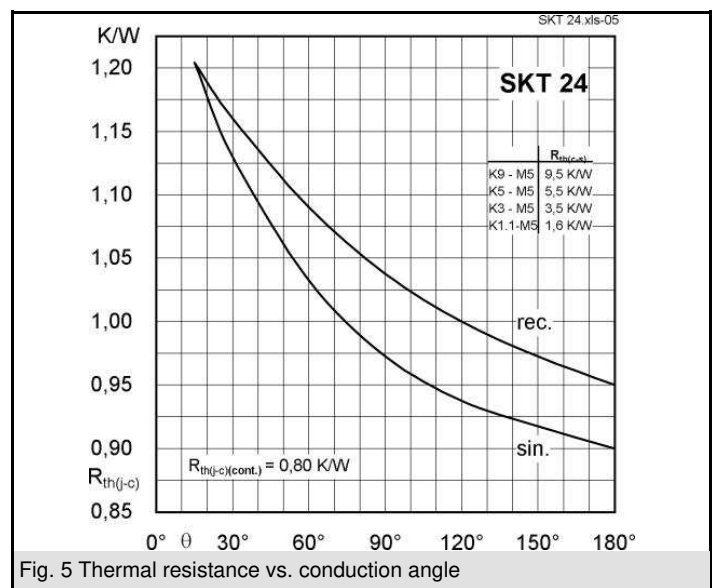
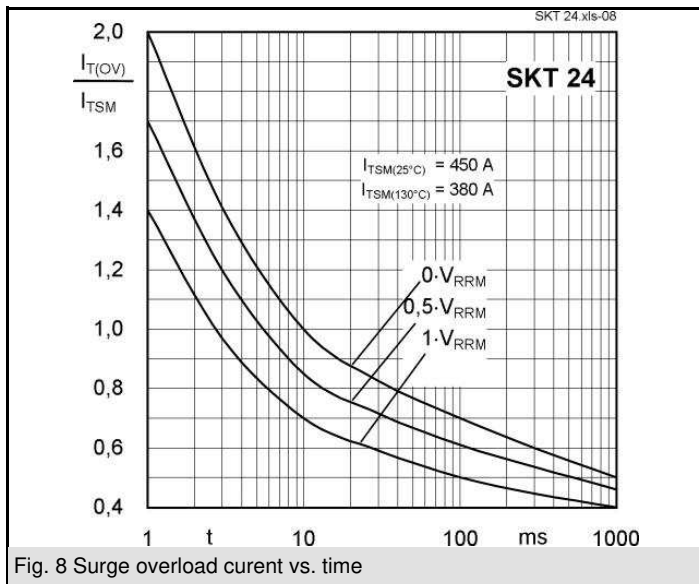
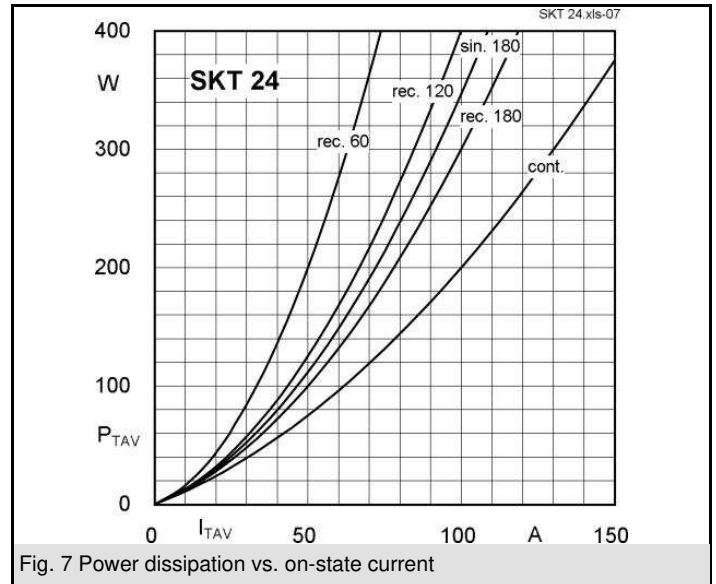
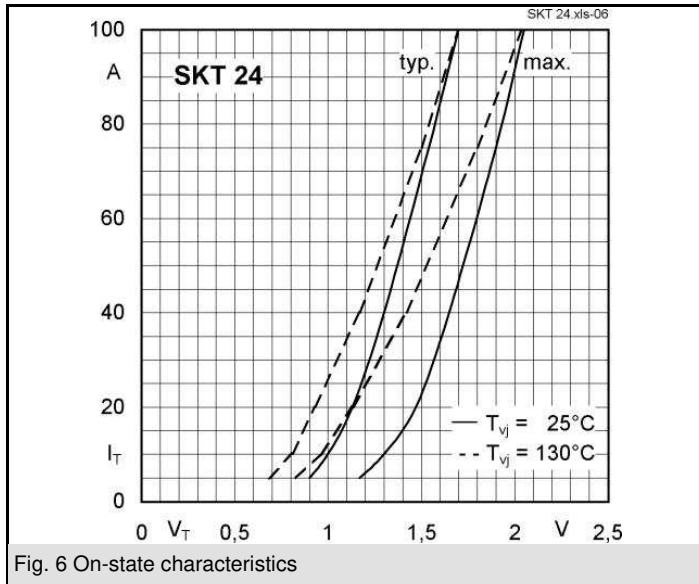
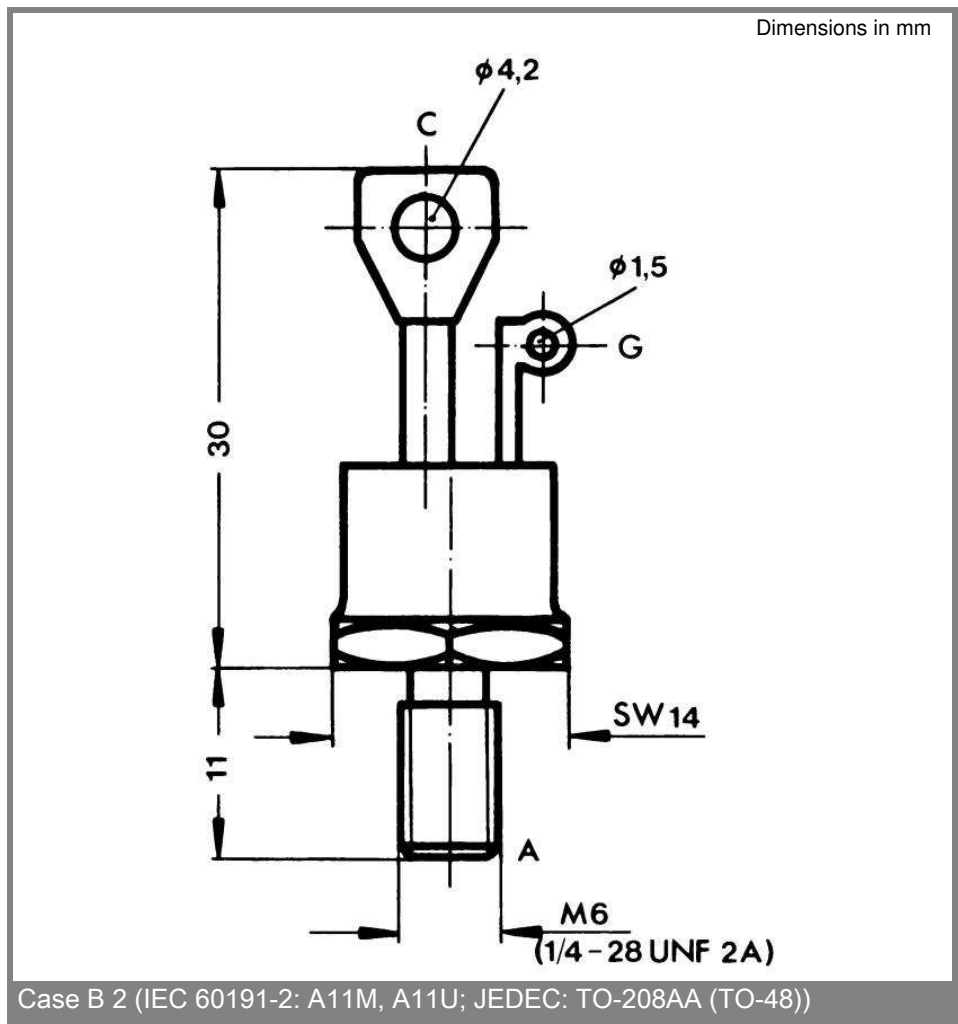
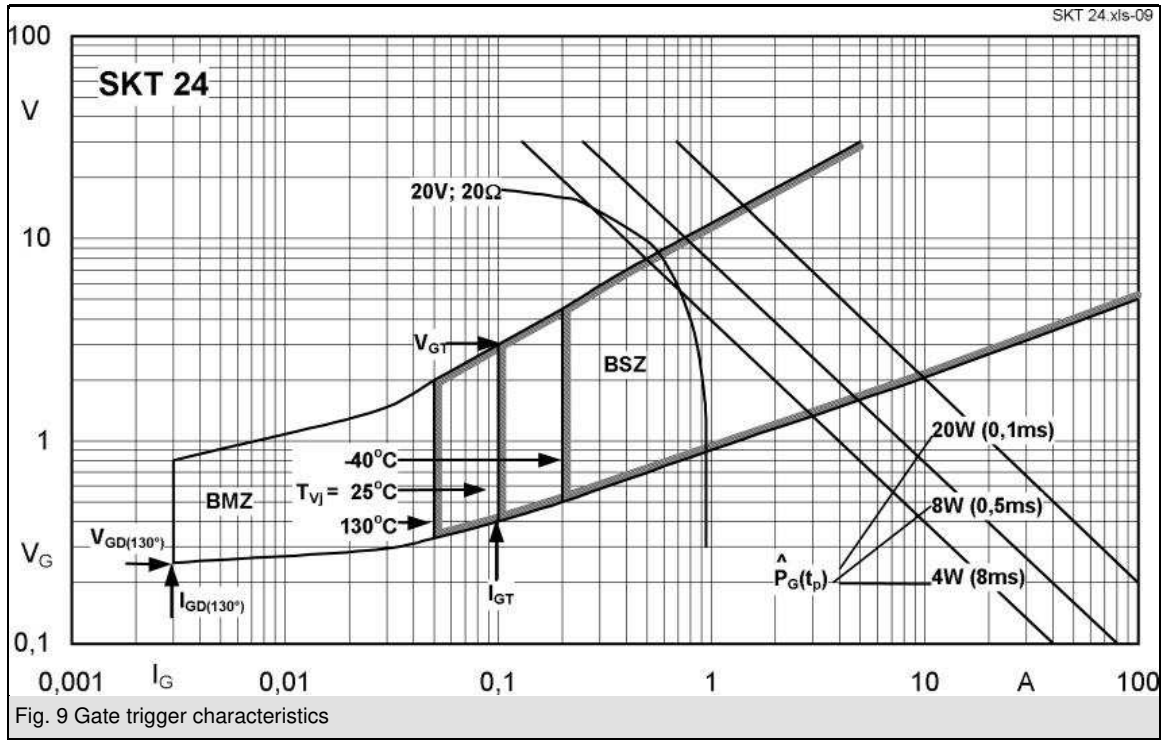

Fig. 5 Thermal resistance vs. conduction angle





\* The specifications of our components may not be considered as an assurance of component characteristics. Components have to be tested for the respective application. Adjustments may be necessary. The use of SEMIKRON

products in life support appliances and systems is subject to prior specification and written approval by SEMIKRON. We therefore strongly recommend prior consultation of our personal.