

# High Power Single Thyristor Modules

$I_{FRMS} = 880 \text{ A}$   
 $I_{FAVM} = 560 \text{ A}$   
 $V_{RRM} = 1200-1800 \text{ V}$

$V_{RSM}$ V	$V_{RRM}$ V	Type
1300	1200	MCO 500-12io1
1500	1400	MCO 500-14io1
1700	1600	MCO 500-16io1
1900	1800	MCO 500-18io1

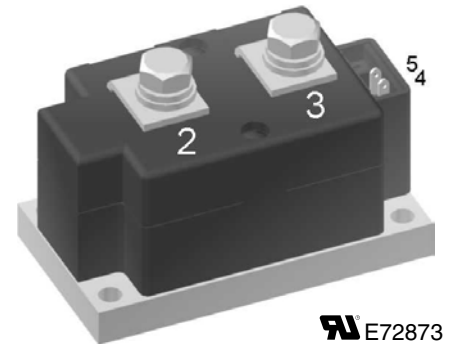
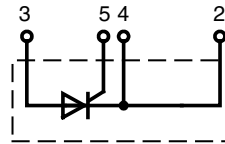

E72873

Symbol	Conditions	Maximum Ratings
$I_{TRMS}$	$T_{VJ} = T_{VJM}$ 180° sine	$T_C = 25^\circ\text{C}$ 880 A $T_C = 85^\circ\text{C}$ 560 A
$I_{TSM}$	$T_{VJ} = 45^\circ\text{C}; V_R = 0$ $t = 10 \text{ ms}$ (50 Hz) $t = 8.3 \text{ ms}$ (60 Hz)	17000 A 16000 A
	$T_{VJ} = T_{VJM}; V_R = 0$ $t = 10 \text{ ms}$ (50 Hz) $t = 8.3 \text{ ms}$ (60 Hz)	13000 A 14400 A
$I^2t$	$T_{VJ} = 45^\circ\text{C}; V_R = 0$ $t = 10 \text{ ms}$ (50 Hz) $t = 8.3 \text{ ms}$ (60 Hz)	1 445 000 A <sup>2</sup> s 1 062 000 A <sup>2</sup> s
	$T_{VJ} = T_{VJM}; V_R = 0$ $t = 10 \text{ ms}$ (50 Hz) $t = 8.3 \text{ ms}$ (60 Hz)	845 000 A <sup>2</sup> s 813 000 A <sup>2</sup> s
$(di/dt)_{cr}$	$T_{VJ} = T_{VJM}; f = 50 \text{ Hz}; t_p = 200 \mu\text{s}; V_D = \frac{2}{3} V_{DRM}; I_G = 1 \text{ A}; di_G/dt = 1 \text{ A}/\mu\text{s}$	repetitive, $I_T = 960 \text{ A}$ 100 A/ $\mu\text{s}$ non repetitive, $I_T = I_{TAVM}$ 500 A/ $\mu\text{s}$
$(dv/dt)_{cr}$	$T_{VJ} = T_{VJM}; V_D = \frac{2}{3} V_{DRM}; R_{GK} = \infty$ ; method 1 (linear voltage rise)	1000 V/ $\mu\text{s}$
$P_{GM}$	$T_{VJ} = T_{VJM}; t_p = 30 \mu\text{s}$ $I_T = I_{T(AV)M}; t_p = 500 \mu\text{s}$	120 W 60 W
$P_{GAV}$		30 W
$V_{RGM}$		10 V
$T_{VJ}$		-40...+140 °C
$T_{VJM}$		140 °C
$T_{stg}$		-40...+125 °C
$V_{ISOL}$	50/60 Hz, RMS $t = 1 \text{ min}$ $I_{ISOL} \leq 1 \text{ mA}$ $t = 1 \text{ s}$	3000 V~ 3600 V~
$M_d$	Mounting torque (M6) Terminal connection torque (M8)	4.5 - 7 Nm 11-13 Nm
Weight	Typical including screws	650 g

## Features

- Direct Copper Bonded Al<sub>2</sub>O<sub>3</sub> ceramic with copper base plate
- Planar passivated chips
- Isolation voltage 3600 V~
- UL registered
- Keyed gate/cathode twin pins

## Applications

- Motor control, soft starter
- Power converter
- Heat and temperature control for industrial furnaces and chemical processes
- Lighting control
- L

## Advantages

- Improved temperature & power cycling
- Reduced protection circuits

Data according to IEC 60747 and refer to a single diode unless otherwise stated.

Symbol	Conditions	Characteristic Values	
		typ.	max.
$I_{RRM}$	$V_R = V_{RRM}$	$T_{VJ} = T_{VJM}$	40 mA
$V_T$	$I_T = 1200$ A	$T_{VJ} = 25^\circ\text{C}$	1.3 V
$V_{T0}$	For power-loss calculations only		0.8 V
$r_t$		$T_{VJ} = T_{VJM}$	0.38 m $\Omega$
$V_{GT}$	$V_D = 6$ V	$T_{VJ} = 25^\circ\text{C}$	2 V
		$T_{VJ} = -40^\circ\text{C}$	3 V
$I_{GT}$	$V_D = 6$ V	$T_{VJ} = 25^\circ\text{C}$	300 mA
		$T_{VJ} = -40^\circ\text{C}$	400 mA
$V_{GD}$	$V_D = \frac{2}{3} V_{DRM}$	$T_{VJ} = T_{VJM}$	0.25 V
$I_{GD}$			10 mA
$I_L$	$t_p = 30$ $\mu\text{s}$ ; $V_D = 6$ V $I_G = 1$ A; $di_G/dt = 1$ A/ $\mu\text{s}$	$T_{VJ} = 25^\circ\text{C}$	400 mA
$I_H$	$V_D = 6$ V; $R_{GK} = \infty$ ;	$T_{VJ} = 25^\circ\text{C}$	300 mA
$t_{gd}$	$V_D = \frac{1}{2} V_{DRM}$ $I_G = 1$ A; $di_G/dt = 1$ A/ $\mu\text{s}$	$T_{VJ} = 25^\circ\text{C}$	2 $\mu\text{s}$
$t_q$	$V_D = \frac{2}{3} V_{DRM}$ $dv/dt = 50$ V/ $\mu\text{s}$ ; $-di/dt = 10$ A/ $\mu\text{s}$ $I_T = 500$ A; $V_R = 100$ V; $t_p = 200$ $\mu\text{s}$	$T_{VJ} = T_{VJM}$	350 $\mu\text{s}$
$R_{thJC}$	DC current		0.072 K/W
$R_{thJK}$	DC current		0.096 K/W
$d_S$	Creeping distance on surface		12.7 mm
$d_A$	Creepage distance in air		9.6 mm
$a$	Maximum allowable acceleration		50 m/s <sup>2</sup>

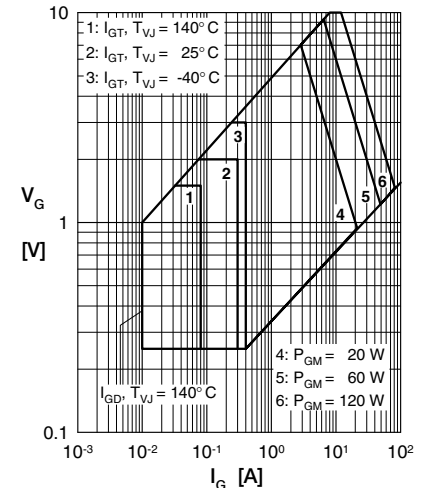

Fig. 1 Gate trigger characteristics

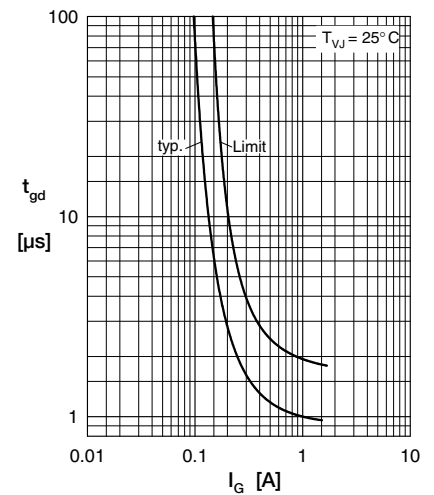
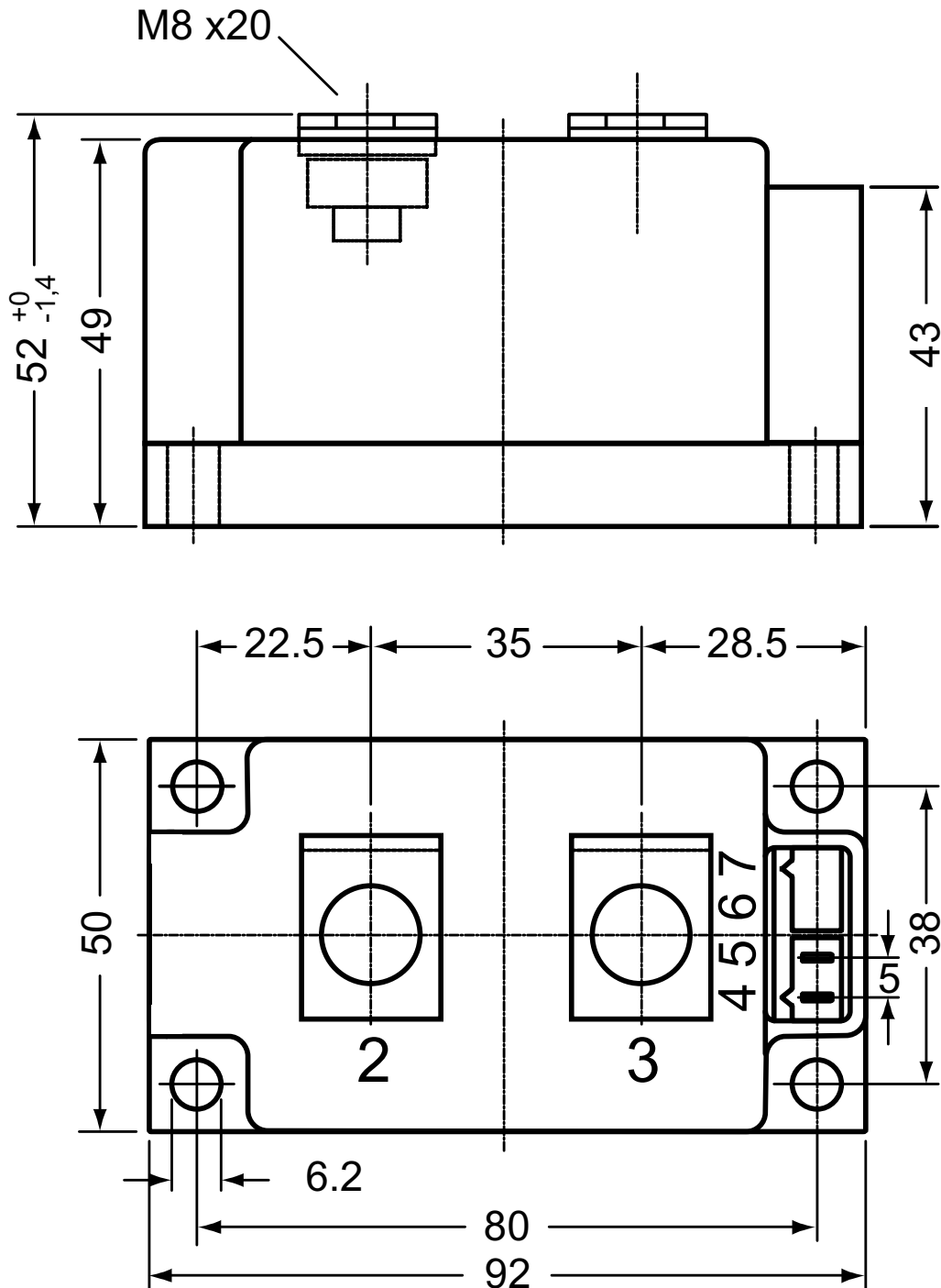

Fig. 2 Gate trigger delay time

Dimensions in mm (1 mm = 0.0394")



### Optional accessories for modules

Keyed gate/cathode twin plugs with wire length = 350 mm, gate = white, cathode = red

Type ZY 180L (L = Left for pin pair 4/5)

Type ZY 180R (R = Right for pin pair 6/7) } UL 758, style 3751

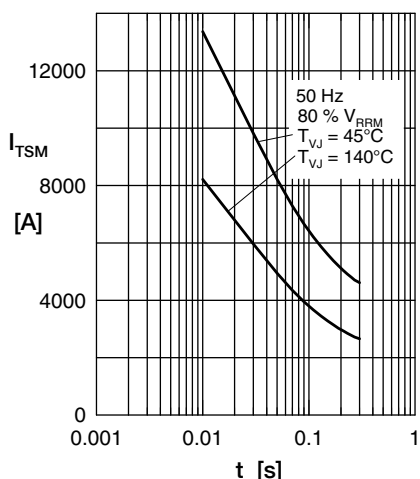

Fig. 3 Surge overload current  
 $I_{TSM}$ : Crest value,  $t$ : duration

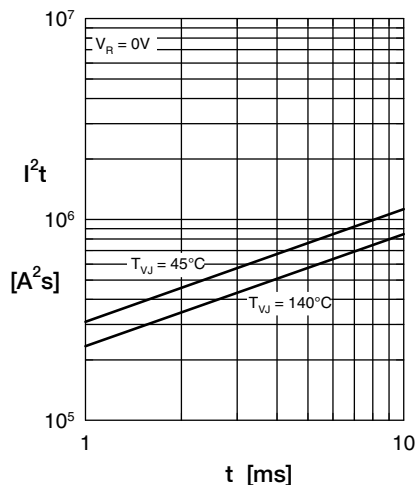

Fig. 4  $I^2t$  versus time (1-10 ms)

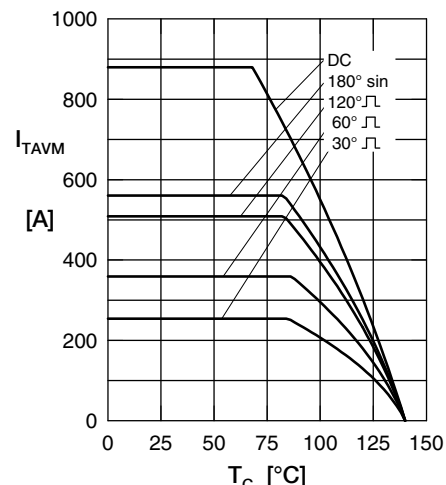

Fig. 5 Maximum forward current at case temperature

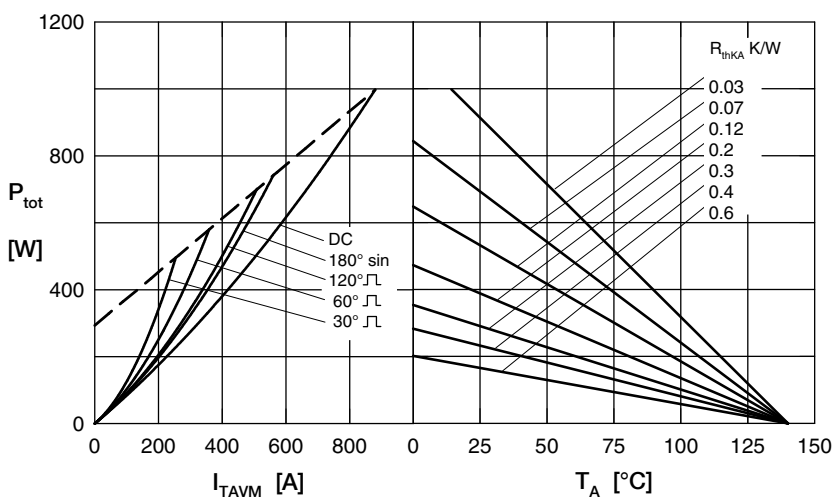

Fig. 6 Power dissipation versus on-state current & ambient temperature

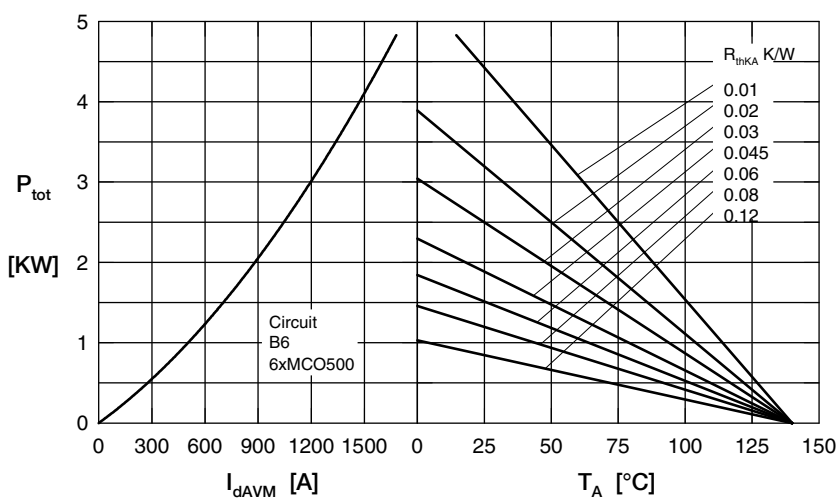

Fig. 7 Three phase rectifier bridge: Power dissipation versus direct output current and ambient temperature

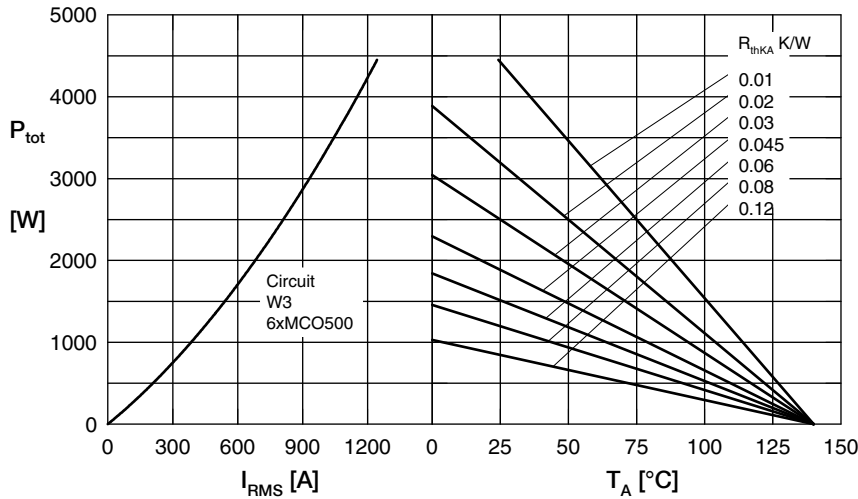

Fig. 8 Three phase AC-controller: Power dissipation versus RMS output current and ambient temperature

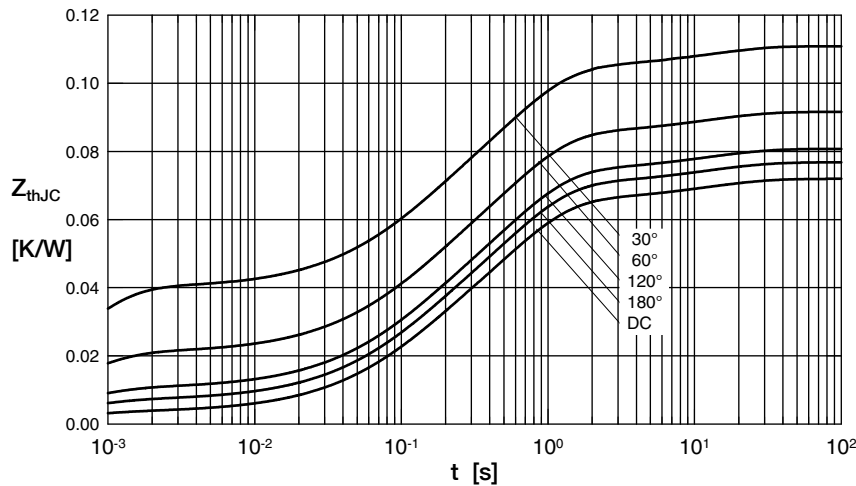

Fig. 9 Transient thermal impedance junction to case

$R_{thJC}$  for various conduction angles d:

d	$R_{thJC}$ (K/W)
DC	0.072
180°	0.0768
120°	0.081
60°	0.092
30°	0.111

Constants for  $Z_{thJC}$  calculation:

i	$R_{thi}$ (K/W)	$t_i$ (s)
1	0.0035	0.00054
2	0.0186	0.098
3	0.0432	0.54
4	0.0067	12

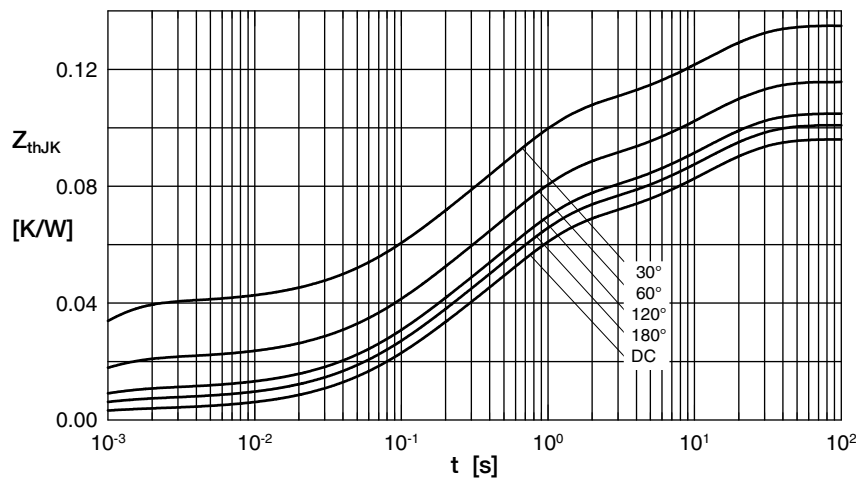

Fig.10 Transient thermal impedance junction to heatsink

$R_{thJK}$  for various conduction angles d:

d	$R_{thJK}$ (K/W)
DC	0.096
180°	0.1
120°	0.105
60°	0.116
30°	0.135

Constants for  $Z_{thJK}$  calculation:

i	$R_{thi}$ (K/W)	$t_i$ (s)
1	0.0035	0.0054
2	0.0186	0.098
3	0.0432	0.54
4	0.0067	12
5	0.024	12