

ESD5500E Series Speed Control Unit

1 SPECIFICATIONS

PERFORMANCE

Isochronous Operation	± 0.25% or better
Speed Range / Governor	1 - 7.5 KHz Continuous
Speed Drift with Temperature	±1% Maximum
Idle Adjust CW	60% of Set Speed
Idle Adjust CCW	Less than 1200 Hz
Droop Range	1 - 5% regulation
Droop Adj. Max. (K-L Jumpered)	400 Hz., ±75 Hz per 1.0 A change
Droop Adj. Min. (K-L Jumpered)	15 Hz., ±75 Hz per 1.0 A change
Speed Trim Range	± 200 Hz
Remote Variable Speed Range	500 - 7.5 KHz
Terminal Sensitivity	
J	100 Hz., ±15 Hz/Volt @ 5.0 K Impedance
L	735 Hz., ±60 Hz/Volt @ 65 K Impedance
N	148 Hz., ±10 Hz/Volt @ 1 Meg Impedance
P	10 VDC Supply @ 20 mA Max

INPUT / OUTPUT

DC Supply	12-24 VDC Battery Systems Transient and Reverse Voltage Protected
Polarity	Negative Ground (Case Isolated)
Power Consumption	50mA continuous plus actuator current
Speed Signal Range	1.0-50 VAC
Actuator Current Range @ 77°F (25°C)	Min. 1.0 A Max. 10 A
Speed Sensor Signal	1.0 - 120 Volts RMS

RELIABILITY

Vibration	1G @ 20-100 Hz
Testing	100% Functionally Tested

ENVIRONMENTAL

Ambient Temperature	-40° to 85°C (-40 to 180°F)
Relative Humidity	up to 95%
All Surface Finishes	Fungus Proof and Corrosion Resistant

COMPLIANCE / STANDARDS

Agency	CE and RoHS Requirements
--------	--------------------------

PHYSICAL

Dimension	See Wiring Diagram and Outline
Weight	1.2 lb. (0.544 kg)
Mounting	Any position, Vertical Preferred

2 INTRODUCTION

The ESD5500E Series are all-electronic devices designed to control engine speed quickly and precisely in response to transient load changes. The ESD5500E will control a wide variety of engines in an isochronous or droop mode when connected to a proportional electric actuator and magnetic speed sensor. The ruggedly built ESD5500E is designed to withstand the engine environment. Light-Force variations are available.

MODELS

PROD. NO.	DESCRIPTION
ESD5500E	Standard Unit
ESD5520E	Light Force
ESD5522E	Light Force / EFC Forward Acting / Enhanced Droop / Smoke Limiting
ESD5526E	For Use With T1 & T2 ATB Gas Applications / Anti Windup
ESD5528E	For Use With T3 & T4 ATB Gas Applications / Anti Windup

3 INSTALLATION & OUTLINE DIAGRAM

Vertical orientation allows fluids to drain in moist environments.



Avoid Extreme Heat



Mount in a cabinet, engine enclosure, or sealed metal box.

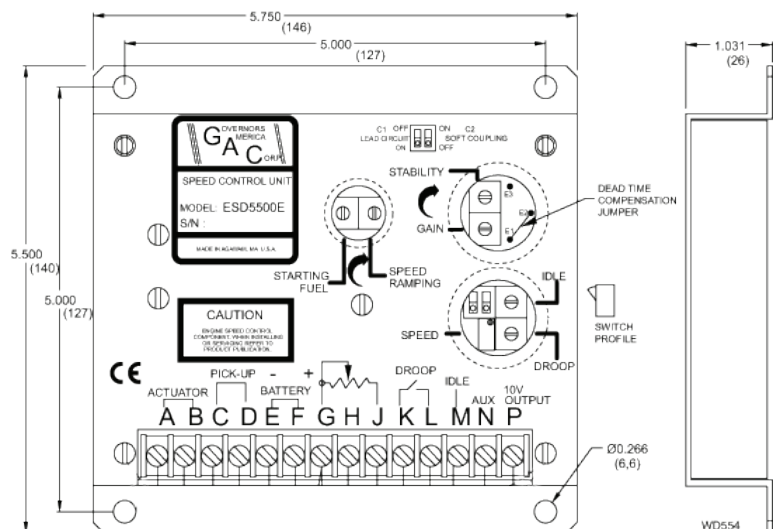

Dimensions in (mm)

4 WIRING

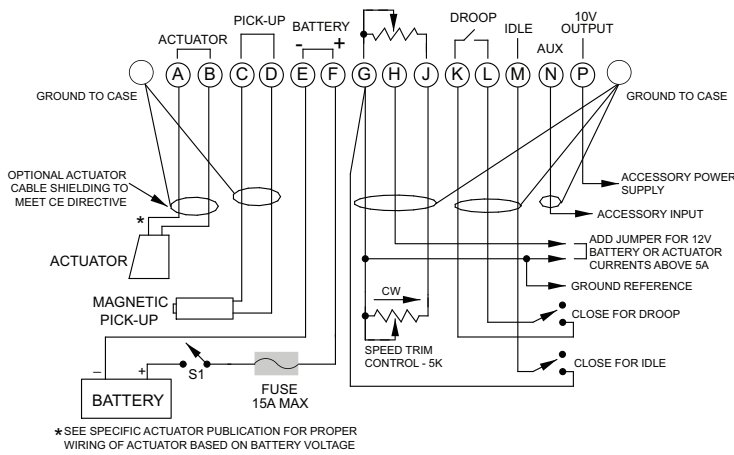

TERMINAL	DEFINITION	NOTES
A & B	Actuator (+/-)	#16 AWG (1.3mm sq) or larger wire Wires must be twisted and/or shielded for their entire length
C & D	Magnetic Speed Pickup (D is ground)	Gap between speed sensor and gear teeth should not be smaller than 0.02 in. (.51mm) Speed sensor voltage needs to be at least 1V AC RMS during crank #16 AWG (1.3mm sq) or larger wire
E & F	Battery Power (-/+)	A 15 amp fuse must be installed in the Positive battery lead to protect against reverse voltage Battery positive (+) input is Terminal F
G	Ground Signal	
H		Add Jumper for 12V Battery or Actuator Currents Above 5A
J	Variable Speed	5K Resistive Nominal. See Section 10 Table 1
K & L	Droop Select	Active When Closed
M	Idle Select	Close for Idle
N	Accessory Input	Load Sharing / Synchronizing, 0-10 VDC
P	Accessory Power Supply	10 Volt Output

RECOMMENDATIONS

- Shielded cable should be used for all external connections to the ESD control.
- One end of each shield, including the speed sensor shield, should be grounded to a single point on the ESD case.

5 ADJUSTMENTS BEFORE ENGINE STARTUP

Make sure the following adjustments are set before starting the engine.

GAIN	Middle Position
STABILITY	Middle Position
SPEED TRIM CONTROL	Middle Position
STARTING FUEL	Full CW (Maximum Fuel)
SPEED RAMPING	Full CCW (Fastest)

6 START THE ENGINE

The speed control unit governed speed setting is factory set at approximately engine idle speed. (1000 Hz., Speed sensor signal or 600 RPM) If the engine does not start, adjustment of the Speed potentiometer may be required.

Crank the engine with DC power applied to the governor system. The actuator will energize to the maximum fuel position until the engine starts. The governor system should control the engine at a low idle speed. If the engine is unstable after starting, refer to Section 8 ADJUSTING FOR STABILITY.

7 GOVERNOR SPEED SETTING

The governed speed set point is increased by clockwise rotation of the SPEED adjustment control. Remote speed adjustment can be obtained with an optional 5K Speed Trim Control.

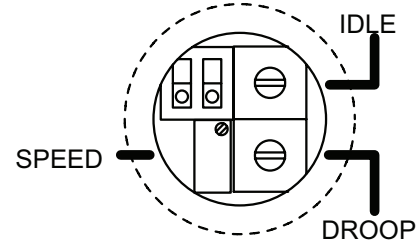

8 ADJUSTING FOR STABILITY

Once the engine is running at operating speed and at no load, the following governor performance adjustments can be made to increase engine stability.

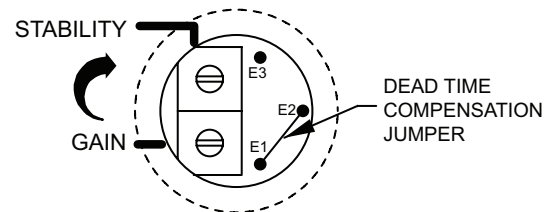

STABILITY ADJUSTMENT

PARAMETER	PROCEDURE
A. GAIN	<ol style="list-style-type: none"> Rotate the GAIN adjustment clockwise until instability develops. Then, gradually move the adjustment counterclockwise until stability returns. Finally, move the adjustment one division further counterclockwise to insure stable performance (270° potentiometer). If instability persists, adjust the next parameter.
B. STABILITY	<ol style="list-style-type: none"> Follow the same adjustment procedure, steps 1 - 3, as the GAIN parameter.

NOTE

Normally, adjustments made at no load achieve satisfactory performance. If further performance improvements are required, refer to Section (12) SYSTEM TROUBLESHOOTING.

9 STARTING FUEL ADJUSTMENT

The engine's exhaust smoke at start-up can be minimized by completing the following adjustments:

ADJUSTMENT PROCEDURE

1. Place the engine in idle by connecting Terminals M & G.
2. Adjust the IDLE speed for as low a speed setting as the application allows.
3. Adjust the STARTING FUEL CCW until the engine speed begins to fall. Increase the STARTING FUEL slightly so that the idle speed is returned to the desired level.
4. Stop the engine.

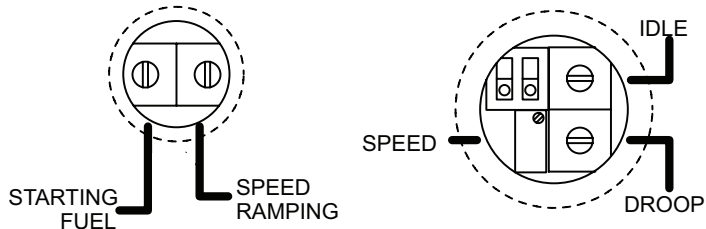

10 TWO METHODS OF OPERATION

One of two methods of operation for the ESD5500E may now be selected.

METHOD 1

Start the engine and accelerate directly to the operating speed (Generator Sets, etc.).

PROCEDURE

1. Remove the connection between Terminals M & G.
2. Start the engine and adjust the SPEED RAMPING for the least smoke on acceleration from idle to rated speed.
3. Start the engine and adjust the SPEED RAMPING for the least smoke on acceleration from idle to rated speed.
4. If the starting time is too long, the STARTING FUEL may need to be adjusted slightly CW.

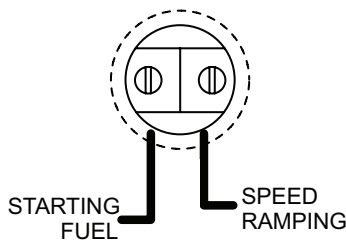

METHOD 2

Start the engine and maintain at an idle speed for a period of time prior to accelerating to the operating speed. This method separates the starting process so that each may be optimized for the lowest smoke emissions.

PROCEDURE

1. Replace the connection between Terminals M & G with a toggle switch or a normally open water jacket temperature switch. Other optical switch combinations can be used.
2. Start the engine.
3. If the starting smoke is excessive, the STARTING FUEL may need to be adjusted slightly CCW.
4. If the starting time is too long, the STARTING FUEL may need to be adjusted slightly CW.
5. When the switch opens, adjust the SPEED RAMPING for the least amount of smoke when accelerating from idle speed to rated speed.

11 ADDITIONAL FEATURES & OPTIONAL WIRING

IDLE SPEED SETTING

If the IDLE speed setting was not adjusted as detailed in Section 9 "Starting Fuel Adjustment", then place the optional external selector switch in the IDLE position. The idle speed set point is increased by the clockwise rotation of the IDLE adjustment control. When the engine is at idle speed, the speed control unit applies droop to the governor system to insure stable operation.

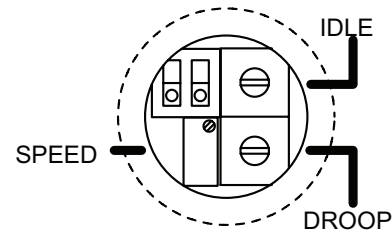

LEAD CIRCUIT & SOFT COUPLING

Switch 1(C1) controls the "Lead Circuit". The normal position is "ON." Move the switch to the "OFF" position if there is fast instability in the system. Switch 2(C2) controls a circuit designed to eliminate fast erratic governor behavior, caused by very soft or worn couplings in the drive train between the engine and generator. The normal position is "OFF." Move to the "ON" position if fast erratic engine behavior due to a soft coupling is experienced.

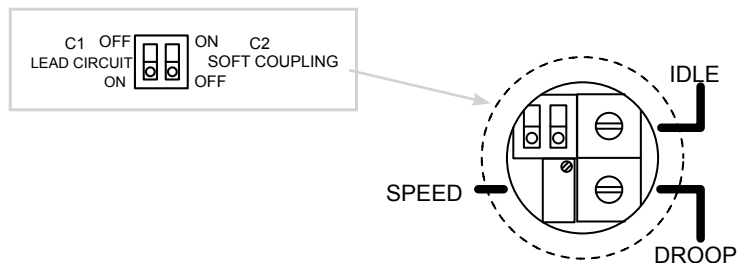

ACCESSORY INPUT

The Auxiliary Terminal N accepts input signals from load sharing units, auto synchronizers, and other governor system accessories, GAC accessories are directly connected to this terminal.

NOTE Terminal N is sensitive. Accessory connections must be shielded.

When an accessory is connected to Terminal N, the speed will decrease and the speed adjustment must be reset.

When operating in the upper end of the control unit frequency range, a jumper wire or frequency trim control may be required between Terminals G and J. This increases the frequency range of the speed control to over 7000 Hz.

If the auto synchronizer is used alone, not in conjunction with a load sharing module, a 3 ohm resistor should be connected between Terminals N and P. This is required to match the voltage levels between the speed control unit and the synchronizer.

Accessory Supply

The +10 volt regulated supply, Terminal P, can be utilized to provide power to GAC governor system accessories. Up to 20 mA of current can be drawn from this supply. Ground reference is Terminal G.

CAUTION A short circuit on this terminal can damage the speed control unit.

WIDE RANGE REMOTE VARIABLE SPEED OPERATION

A single remote speed adjustment potentiometer can be used to adjust the engine speed continuously over a specific speed range.

Select the desired speed range and corresponding potentiometer value. (Refer to TABLE 1 below) If the exact range cannot be found, select the next higher range potentiometer.

To maintain engine stability at the minimum speed setting, a small amount of droop can be added using the DROOP adjustment. At the maximum speed setting the governor performance will be near isochronous, regardless of the droop adjustment setting.

NOTE An additional fixed resistor may be placed across the potentiometer to obtain the exact desired range. Connect the speed range potentiometer as shown to the right using Terminals G and J. Contact GAC for assistance if difficulty is experienced in obtaining the desired variable speed governing performance.

TABLE 1

SPEED FREQUENCY RANGE	POTENTIOMETER VALUE
900 Hz	1 K
2400 Hz	5 K
3000 Hz	10 K
3500 Hz	25 K
3700 Hz	50 K

Conversion Formulas

$$\text{Hertz}_{\text{MAG PICKUP}} = \frac{(\text{RPM} \times \# \text{Teeth})}{60\text{sec}} \quad \text{RPM} = \frac{(\text{Hertz}_{\text{MAG PICKUP}} \times 60\text{sec})}{\# \text{Teeth}}$$

POTENTIOMETER WIRING

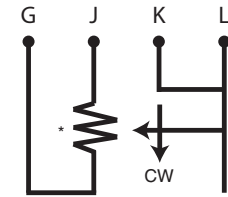

* Select proper potentiometer value from Table 1

NOTE

The ESD5000 series of controllers have the ability to expand the speed range by placing a jumper wire across terminals G and J. The standard range is 7400 Hz however this is based on the operating speed and the number of flywheel teeth (see formula). If your application is above this frequency, or near it – place the jumper and test again. This is an important step if your engine is not able to reach rated speed but the actuator is not saturated.

SPEED DROOP OPERATION

Droop is typically used for the paralleling of engine driven generators. When in droop operation, the engine speed will decrease as engine load increases. The percentage of droop is based on the actuator current change from no engine load to full load.

Place the optional external selector switch in the DROOP position. DROOP is increased by clockwise rotation of the DROOP adjustment control.

After the droop level has been adjusted, the rated engine speed setting may need to be reset. Check the engines speed and adjust that speed setting accordingly.

NOTE

Though a wide range of droop is available with the internal control, droop level requirements of 10% are unusual. If droop levels experienced are higher or lower than those required, contact GAC for assistance.

12 TROUBLESHOOTING

If the engine governing system does not function, the fault may be determined by performing the voltage tests described in Steps 1 through 4. Positive (+) and negative (-) refer to meter polarity. Should normal values be indicated during troubleshooting steps, and then the fault may be with the actuator or the wiring to the actuator. Tests are performed with battery power on and the engine off, except where noted. See actuator publication for testing procedure on the actuator.

SYSTEM INOPERATIVE

STEP	WIRES	NORMAL READING	PROBABLE CAUSE OF ABNORMAL READING
1	F(+) & E(-)	Battery Supply Voltage (12 or 24 VDC)	1. DC battery power not connected. Check for blown fuse.
			2. Low battery voltage
			3. Wiring error
2	C(+) & D(-)	1.0 VAC RMS min. while cranking	1. Gap between speed sensor and gear teeth too great. Check Gap.
			2. Improper or defective wiring to the speed sensor. Resistance between D and C should be 160 to 1200 ohms. See specific mag pickup data for resistance.
			3. Defective speed sensor.
3	P(+) & G(-)	10 VDC, Internal Supply	1. Short on Terminal P.
			2. Defective speed control unit.
4	F(+) & A(-)	1.0 - 2.0 VDC while cranking	1. SPEED parameter set too low
			2. Short/open in actuator wiring
			3. Defective speed control
			4. Defective actuator, see Actuator Troubleshooting

INSTABILITY

INSTABILITY	SYMPTOM	PROBABLE CAUSE OF ABNORMAL READING
Fast Periodic	The engine seems to jitter with a 3Hz or faster irregularity of speed.	<ol style="list-style-type: none"> 1. Make sure switch C1 is set to "OFF". 2. Readjust the GAIN and STABILITY for optimum control. 3. Remove the E1 to E2 jumper. Readjust GAIN and Stability afterward. 4. Turn off other electrical equipment that may be causing interference.
Slow Periodic	An irregularity of speed below 3Hz.	<ol style="list-style-type: none"> 1. Readjust the GAIN and STABILITY 2. Adjust the DEAD TIME COMPENSATION by adding a capacitor from posts E2 to E3 (negative on E2). Start with 10 mfd. and increase until instability is eliminated. 3. Check fuel system linkage during engine operation for: <ol style="list-style-type: none"> a. binding b. high friction c. poor linkage
Non-Periodic	Erratic Engine Behavior	<ol style="list-style-type: none"> 1. Increasing the GAIN should reduce the instability but not totally correct it. If this is the case, there is most likely a problem with the engine itself. Check for: <ol style="list-style-type: none"> a. engine mis-firings b. an erratic fuel system c. load changes on the generator set voltage regulator. 2. If throttle is slightly erratic, but performance is fast, then move switch C1 to the "OFF" position.

UNSATISFACTORY PERFORMANCE

SYMPTOM	NORMAL READING	PROBABLE CAUSE OF ABNORMAL READING
Engine Overspeeds	<ol style="list-style-type: none"> 1. Do Not Crank. Apply DC power to the governor system. 2. Manually hold the engine at the desired running speed. Measure the DC voltage between Terminals A(-) & F(+) on the speed control unit. 	<ol style="list-style-type: none"> 1. After the actuator goes to full fuel, disconnect the speed sensor at Terminal C & D. If the actuator is still at full fuel-speed then the speed control unit is defective. 2. If the actuator is at minimum fuel position and there exists an erroneous position signal, then check speed sensor cable. 1. If the voltage reading is 1.0 to 1.5 VDC: <ol style="list-style-type: none"> a. SPEED adjustment is set above desired speed b. Defective speed control unit 2. If voltage reading is above 1.5 VDC then check for: <ol style="list-style-type: none"> a. actuator binding b. linkage binding 3. If the voltage reading is below 0.8 VDC: <ol style="list-style-type: none"> a. Defective speed control unit
Actuator does not energize fully	<ol style="list-style-type: none"> 1. Measure the voltage at the battery while cranking. 2. Momentarily connect Terminals A and F. The actuator should move to the full fuel position. 3. Measure frequency of magnetic speed pickup (or calculate). 	<ol style="list-style-type: none"> 1. If the voltage is less than: <ol style="list-style-type: none"> a. 7V for a 12V system, or b. 14V for a 24V system, Then: Check or replace battery. 1. Actuator or battery wiring in error 2. Actuator or linkage binding 3. Defective actuator
Engine remains below desired governed speed	<ol style="list-style-type: none"> 1. Measure the actuator output, Terminals A & B, while running under governor control. 	<ol style="list-style-type: none"> 1. If above 7000 Hz then add jumper to terminal G and J. 1. If voltage measurement is within 2 VDC of the battery supply voltage level, then fuel control is restricted from reaching full fuel position, possibly due to mechanical governor, carburetor spring, or linkage interference. 2. SPEED parameter set too low

INSUFFICIENT MAGNETIC SPEED SIGNAL

A strong magnetic speed sensor signal will eliminate the possibility of missed or extra pulses. The speed control unit will govern well with 1.0 volts RMS speed sensor signal. A speed sensor signal of 3 VAC or greater at governed speed is recommended. Measurement of the signal is made at Terminals C and D.

The amplitude of the speed sensor signal can be raised by reducing the gap between the speed sensor tip and the engine ring gear. The gap should not be any smaller than 0.020 in (0.45 mm). When the engine is stopped, back the speed sensor out by 3/4 turn after touching the ring gear tooth to achieve a satisfactory air gap.