

## FRED

### Ultrafast Soft Recovery Diode, 2 x 10 A

**FEATURES**

- Ultrafast recovery
- Ultrasoft recovery
- Very low  $I_{RRM}$
- Very low  $Q_{rr}$
- Specified at operating conditions
- Designed and qualified for industrial level

**BENEFITS**

- Reduced RFI and EMI
- Reduced power loss in diode and switching transistor.
- Higher frequency operation
- Reduced snubbing
- Reduced parts count

**APPLICATIONS**

- Switching mode power supplies
- UPS
- DC/DC converters
- Free wheeling diodes
- Inverters
- Motor drives

**DESCRIPTION**

**D92-02** is a state of the art center tap ultrafast recovery diode. Employing the latest in epitaxial construction and advanced processing techniques it features a superb combination of characteristics which result in performance which is unsurpassed by any rectifier previously available. With basic ratings of 200V and 10 A per leg continuous current, the **D92-02** is especially well suited for use as the companion diode for IGBTs and MOSFETs. The FRED features combine to offer designers a rectifier with lower noise and significantly lower switching losses in both the diode and the switching transistor. These FRED advantages can help to significantly reduce snubbing, component count and heatsink sizes.

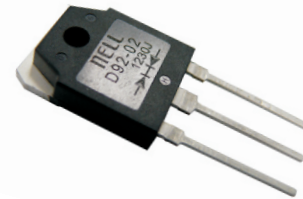

TO-3PB

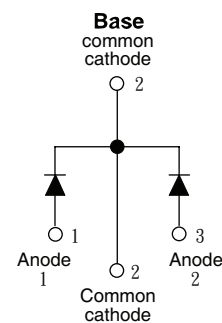

PRODUCT SUMMARY	
$V_R$	200 V
$V_F$ at 10A at 25 °C	0.95 V
$I_{F(AV)}$	2 x 10 A
$t_{rr}$ (typical)	35 ns
$T_J$ (maximum)	150 °C
$Q_{rr}$ (typical)	25 nC
$I_{RRM}$ (typical)	1.9 A

ABSOLUTE MAXIMUM RATINGS				
PARAMETER	SYMBOL	TEST CONDITIONS	VALUES	UNIT
Cathode to anode voltage	$V_R$		200	V
Maximum continuous forward current	$I_F$	per leg	10	A
		per device	20	
Single pulse forward current (Peak forward current per leg)	$I_{FSM}$	50Hz square wave duty = 1/2, $T_C = 115^\circ\text{C}$	100	
Maximum repetitive forward current (per leg)	$I_{FRM}$		40	
Operating junction and storage temperature range	$T_J, T_{Stg}$		- 55 to + 150	°C

## Nell High Power Products

ELECTRICAL SPECIFICATIONS ( $T_J = 25\text{ }^\circ\text{C}$ unless otherwise specified)						
PARAMETER	SYMBOL	TEST CONDITIONS	MIN.	TYP.	MAX.	UNIT
Cathode to anode breakdown voltage	$V_{BR}$	$I_R = 100\ \mu\text{A}$	200	-	-	V
Maximum forward voltage	$V_{FM}$	$I_F = 10\ \text{A}$	-	0.9	0.95	
		$I_F = 20\ \text{A}$	-	1	-	
		$I_F = 10\ \text{A}, T_J = 125\text{ }^\circ\text{C}$	-	0.8	-	
Maximum reverse leakage current	$I_{RM}$	$V_R = V_R\ \text{rated}$	-	-	15	$\mu\text{A}$
		$T_J = 125\text{ }^\circ\text{C}, V_R = V_R\ \text{rated}$	-	-	250	
Junction capacitance	$C_T$	$V_R = 200\text{V}$	-	55	-	pF
Series inductance	$L_S$	Measured lead to lead 5 mm from package body	-	8	-	nH

DYNAMIC RECOVERY CHARACTERISTICS PER LEG $T_J = 25\text{ }^\circ\text{C}$ unless otherwise specified)						
PARAMETER	SYMBOL	TEST CONDITIONS	MIN.	TYP.	MAX.	UNIT
Reverse recovery time	$t_{rr}$	$I_F = 0.5\text{A}, I_R = 1.0\text{A}, I_{RR} = 250\text{mA}$ (RG#1 CKT)	-	14	20	ns
		$I_F = 1.0\ \text{A}, di_F/dt = 50\ \text{A}/\mu\text{s}, V_R = 30\ \text{V}, T_J = 25\text{ }^\circ\text{C}$	-	-	30	
	$t_{rr1}$	$T_J = 25\text{ }^\circ\text{C}$	-	21	-	
	$t_{rr2}$	$T_J = 125\text{ }^\circ\text{C}$	-	35	-	
Peak recovery current	$I_{RRM1}$	$T_J = 25\text{ }^\circ\text{C}$	-	1.9	-	A
	$I_{RRM2}$	$T_J = 125\text{ }^\circ\text{C}$	-	4.8	-	
Reverse recovery charge	$Q_{rr1}$	$T_J = 25\text{ }^\circ\text{C}$	-	25	-	nC
	$Q_{rr2}$	$T_J = 125\text{ }^\circ\text{C}$	-	78	-	

THERMAL - MECHANICAL SPECIFICATIONS PER LEG						
PARAMETER	SYMBOL	TEST CONDITIONS	MIN.	TYP.	MAX.	UNITS
Lead temperature	$T_{lead}$	0.063" from case (1.6 mm) for 10 s	-	-	300	$^\circ\text{C}$
Junction to case, single leg conduction	$R_{thJC}$		-	-	1.5	K/W
Junction to case, both legs conducting			-	-	0.7	
Thermal resistance, junction to ambient	$R_{thJA}$	Typical socket mount	-	-	40	
Thermal resistance, case to heatsink	$R_{thCS}$	Mounting surface, flat, smooth and greased	-	0.25	-	
Weight			-	5.5 0.19	-	g oz.
Mounting torque			6 (5)	-	12 (10)	kgf . cm (lb . in)
Marking device		Case style TO-3PB (JEDEC)	D92-02			

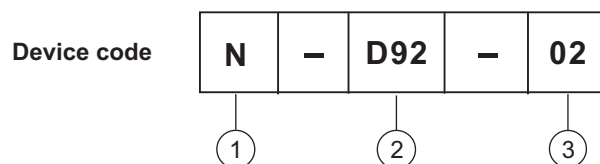
**ORDERING INFORMATION TABLE**

- 1 - Nell Semiconductors product
- 2 - FRED family, type = D92, current rating = 10A x 2, package outline = TO-3PB
- 3 - Voltage rating, 02 = 200V

## Nell High Power Products

**Fig.1 Maximum forward voltage drop characteristics**

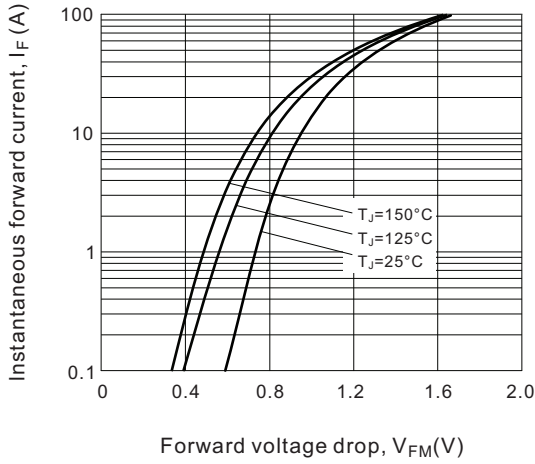

**Fig.2 Typical values of reverse current vs. reverse voltage**

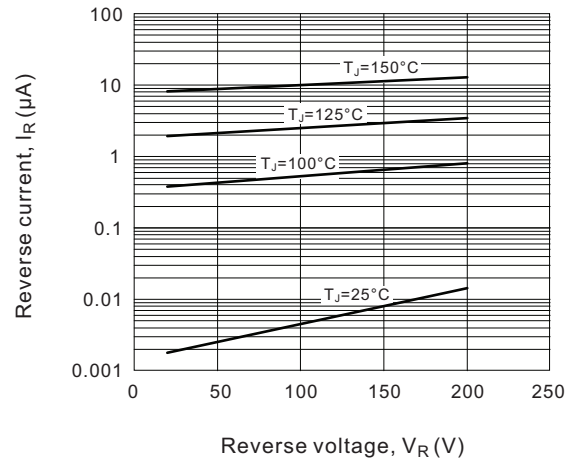

**Fig.3 Typical junction capacitance vs. reverse voltage**

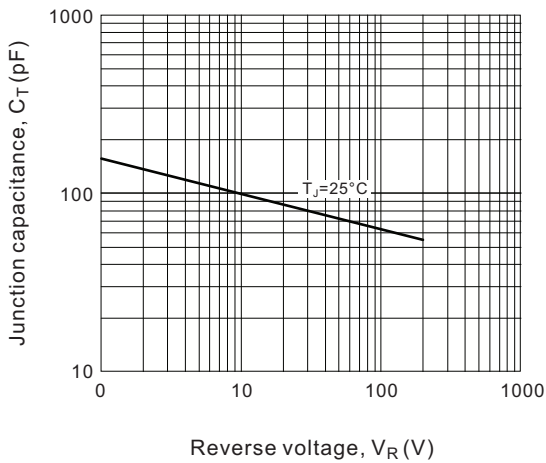

**Fig.4 Maximum allowable case temperature vs. average forward current**

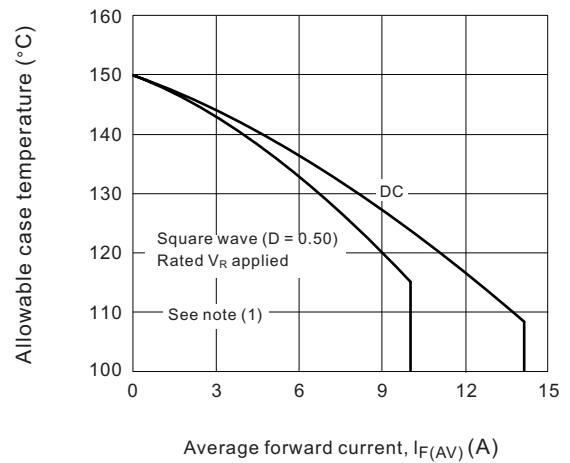

**Fig.5 Maximum thermal impedance  $R_{th(j-c)}$  characteristics**

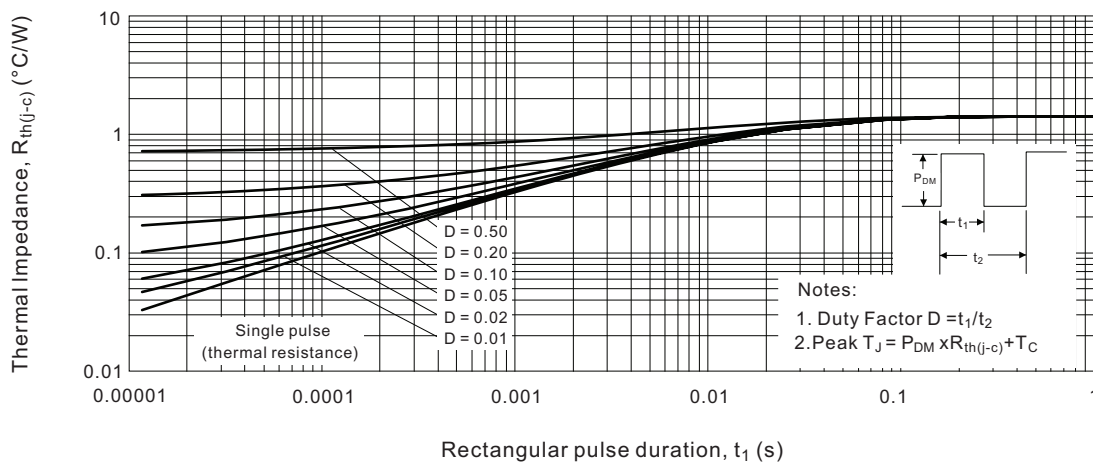

**Fig.6 Forward power loss characteristics**

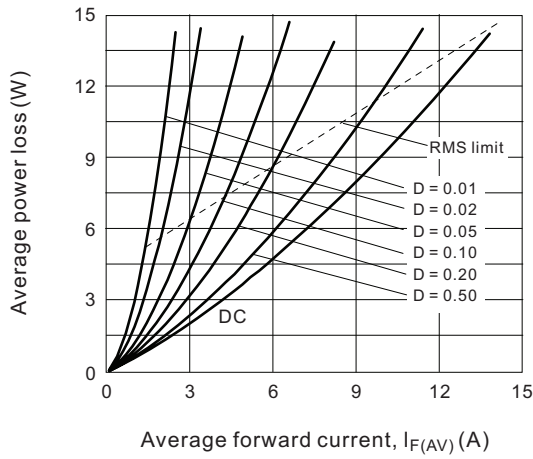

**Fig.7 Typical reverse recovery time vs.  $di_F/dt$**

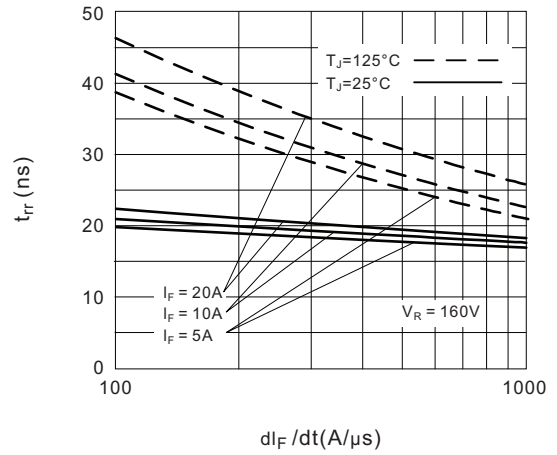

**Fig.8 Typical stored charge vs.  $di_F/dt$**

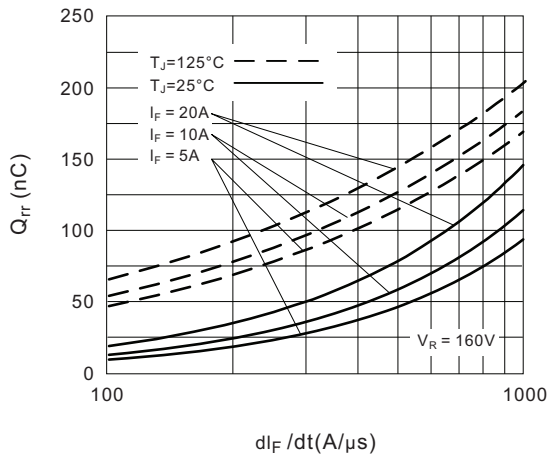

**Fig.9 Reverse recovery parameter test circuit**

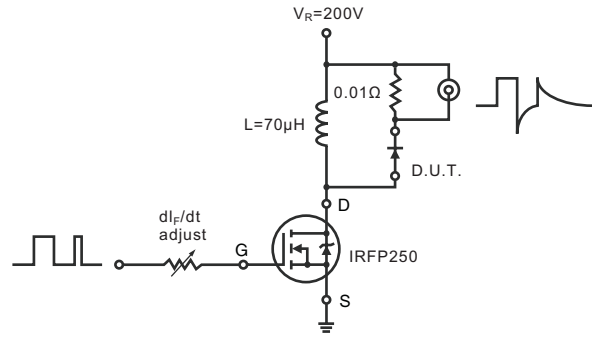

**Note**

- (1) Formula used:  $T_C = T_J - (Pd + Pd_{REV}) \times R_{thJC}$ ;  
 $Pd$  = Forward power loss =  $I_{F(AV)} \times V_{FM}$  at  $(I_{F(AV)}/D)$  (see fig.6);  
 $Pd_{REV}$  = Inverse power loss =  $V_{R1} \times I_R (1-D)$ ;  $I_R$  at  $V_{R1}$  = Rated  $V_R$

Fig.10 Reverse recovery waveform and definitions

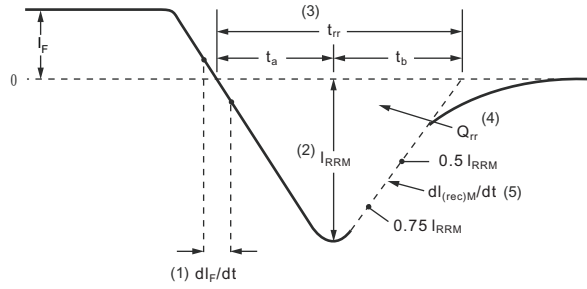

- (1)  $dl_F/dt$  - rate of change of current through zero crossing
- (2)  $I_{RRM}$  - peak reverse recovery current
- (3)  $t_{rr}$  - reverse recovery time measured from zero crossing point of negative going  $I_F$  to point where a line passing through  $0.75 I_{RRM}$  and  $0.50 I_{RRM}$  extrapolated to zero current.
- (4)  $Q_{rr}$  - area under curve defined by  $t_{rr}$  and  $I_{RRM}$
- (5)  $dl_{(rec)M}/dt$  - peak rate of change of current during  $t_b$  portion of  $t_{rr}$

$$Q_{rr} = \frac{t_{rr} \times I_{RRM}}{2}$$

TO-3PB

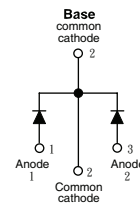
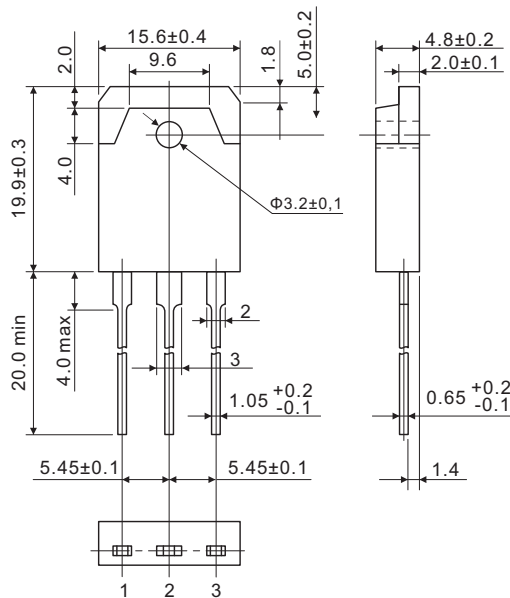

All dimensions in millimeters