

# Let Us Offer You More Energy Solutions Today

Camelion has provided consumer friendly solutions for customers worldwide for over 17 years. Our customers have been consistently satisfied with our quality, prices and attention to detail. We offer a broad range of energy solutions. Try us out today.

2014

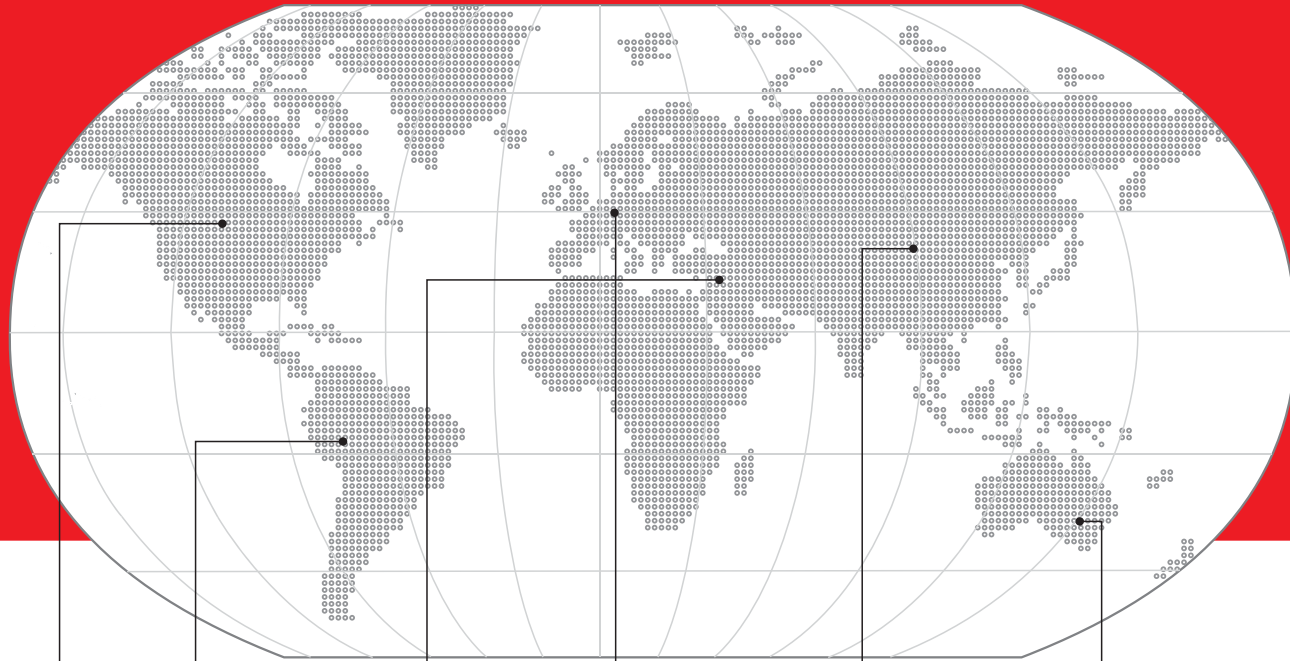

- North America**
  - Canada
  - U. S. A
- Caribbean/ Latin America**
  - Argentina
  - Brazil
  - Bolivia
  - Chile
  - Colombia
  - Costa Rica
  - Cuba
  - Dominica
  - Ecuador
  - EL Salvador
  - Guatemala
  - Haiti
  - Mexico
  - Nicaragua
  - Panama
  - Paraguay
  - Peru
  - Puerto Rico
  - Trinidad and Tobago
  - Uruguay
  - Venezuela
- Middle East /Africa**
  - Algeria
  - Benin
  - Egypt
  - Iran
  - Israel
  - Kuwait
  - Lebanon
  - Sierra Leone
  - Saudi Arabia
  - Syria
  - S. Africa
  - Tunisia
  - U.A.E.
  - Uganda
- Europe**
  - Austria
  - Albania
  - Andorra
  - Belarus
  - Belgium
  - Bosnia
  - Bulgaria
  - Czech Republic
  - Croatia
  - Cyprus
  - Denmark
  - Estonia
  - Finland
  - France
  - Germany
  - Georgia
  - Greece
  - Hungary
  - Iceland
  - Ireland
  - Italy
  - Latvia
  - Lithuania
  - Luxembourg
  - Macedonia
  - Malta
  - Netherland
  - Norway
  - Portugal
  - Poland
  - Romania
  - Russia
  - Serbia
  - Slovakia
  - Slovenia
  - Spain
  - Sweden
  - Switzerland
  - Turkey
  - United Kingdom
  - Ukraine
- Asia**
  - Afghanistan
  - Armenia
  - Azerbaijan
  - Bangladesh
  - Cambodia
  - China
  - Hong Kong
  - Indonesia
  - India
  - Iraq
  - Japan
  - Jordan
  - Korea
  - Kazakhstan
  - Lao
  - Malaysia
  - Pakistan
  - Philippines
  - Singapore
  - Sri Lanka
  - Taiwan
  - Thailand
  - Turkmenistan
  - Vietnam
  - Yemen
- Oceania**
  - Australia
  - Fiji
  - New Zealand

# Product Catalogue

**EUROPE HEAD OFFICE / WAREHOUSE**  
 Camelion Batterien GmbH.  
 Bergiusstr. 53-59, D - 12057 Berlin,  
 Germany

For more information visit [www.camelion.com](http://www.camelion.com)  
 Copyright ©2014 Batterien GmbH, All rights reserved.

CA-2014GB

[www.camelion.com](http://www.camelion.com)





Camelion manufactures a wide range of **high quality** products to give the consumer

**More Energy Solutions**  
for their Electronic Equipments at a Reasonable Cost

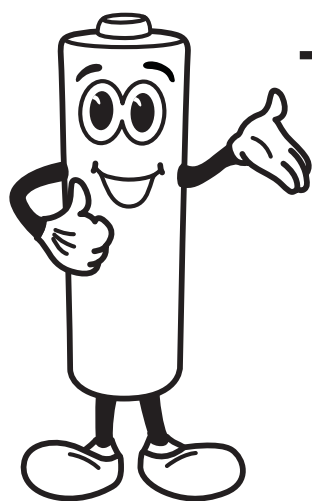

Try us out today!

- Primary Batteries
- Rechargeable Batteries and Chargers
- Flashlights and Lanterns
- Power Supplies

When you need more energy solutions, try Camelion!

# CONTENT

## Primary Batteries

Lithium	6
9V Lithium	6
Digi Alkaline	7
Plus Alkaline	8
Super Heavy Duty (Blue)	14
Super Heavy Duty (Green)	15
Photo Lithium	19

## Electronic Button Cells

Electronics Lithium	20
Electronics Alkaline	20
Electronics Silver Oxide	22
Zinc Air	22
<b>Battery Accessoires</b>	<b>23</b>
<b>Battery Selection Chart</b>	<b>24</b>

## Rechargeable Batteries

AlwaysReady	26
Ni-MH	28

## Battery Chargers

<b>Green Energy Chargers</b>	
SBC-3001	32
<b>Ultra Fast Chargers</b>	
BC-0907	33
<b>Super Fast Chargers</b>	
BC-1007	34
BC-0903	35
<b>Fast Chargers</b>	
BC-1002A	36
BC-1012	37

<b>Overnight Chargers</b>	
BC-1001A	38
BC-1021C	39
BC-0901	40
BC-0902	41
BC-0904S	42
BC-0908	43
<b>Universal Chargers</b>	
CM9398GS	44
CM9388	45
CM3298	46
LBC-312	47
<b>Battery Charging Table</b>	<b>48</b>

## Power Supplies

### USB Car Chargers

DD801	51
DD802	51

### USB Power Adapters

AD5028	52
AD3127	52
PS625F	53
PS626	53
PS627	54
Device Chart	54

## Battery Powered Flashlights

### TUFFeLite™ Flashlights

T7071, T7012, T5	56
------------------	----

### TRAVLite™ Flashlights

<b>LED Pocket Flashlight</b> HP7011	58
<b>LED Rubber Flashlight</b> PT6L2D, PT3L2AA	58
<b>LED Lantern</b> SL7051, SL1011	60

### SuperBright™ Flashlights

<b>Multi-head LED Classic</b> FL6L2D, FL3L2AA	62
<b>Multi-head LED Search Lamp</b> FL-16LED, FL-9LED	64
<b>Classic Flashlight</b> FL1L2D, FL1L2C, FL1L2AA	66

### HomeBright™ Flashlights

<b>Search Lamp</b> CM25B1, CM4AA01	68
---------------------------------------	----

### Professional Products

<b>Penlight</b> DL2AAAS	69
----------------------------	----

### CT-Series LED Flashlights

<b>High grade aluminium flashlight with maximum illumination</b> CT4002, CT4004, CT4005, CT4010	70
<b>LED Lantern</b> Solar Lantern, CT4008	72
<b>3 Watt Headlight</b> CT4007	72
<b>2 + 1 LED Solar Keychain</b> CT4011	72

## Rechargeable Flashlights

### HyberBrite™ Flashlights

T7, T8, T9, T10, RT3071	74
-------------------------	----

### Flashlight Replacement Bulbs

LED bulbs	76
Vacuum and Krypton	76

## Promotional

77

# Primary Batteries



## Lithium P<sup>7</sup> Batteries

Camelion Lithium P7™ batteries offer a unique combination of lightness and high energy density. As Camelion's most powerful primary battery, the P7 batteries, offer unbeatable performance for your high drain devices such as digital cameras, music players and games. It can be stored up to 10 years.



EMPORIO URTEIL	
Camelion Lithium AA	
<b>GUT</b>	81,7 %
22 AA-Batterien im Vergleichstest Heft 11/2008	



### FR6-BP2

1.5V AA

<b>Packaging</b>	
Blister	2 pcs/pack
Inner Box	12 packs/box
Outer Carton	216 packs/carton
<b>Gross Weight:</b>	9.3 kg
<b>Volume:</b>	0.0251 cbm

#### Dimensions

Blister (mm)	84(W) x 114(H) x 15(D)
Inner Box (mm)	131(L) x 98(W) x 86(H)
Outer Carton (cm)	41.5(L) x 27.5(W) x 22.0(H)



### FR03-BP2

1.5V AAA

<b>Packaging</b>	
Blister	2 pcs/pack
Inner Box	12 packs/box
Outer Carton	288 packs/carton
<b>Gross Weight:</b>	8.0 kg
<b>Volume:</b>	0.0237 cbm

#### Dimensions

Blister (mm)	84(W) x 114(H) x 11(D)
Inner Box (mm)	119(L) x 75(W) x 86(H)
Outer Carton (cm)	32.5(L) x 26.0(W) x 28.0(H)



## 9V Lithium Battery

The new Lithium 9V Battery from Camelion is a high capacity battery designed to provide long lasting life and stable operating voltage.

- Up to 5x Longer Lasting\*
- Low Self Discharge
- Anti leakage crimp design
- Temperature Range -20°C to +55°C
- Non-rechargeable
- 10 Year Shelf Life
- High And Stable Operating Voltage



\*compare with alkaline batteries. Camelion 2010 Lab Tests.



### CR9V-BP1

9V

<b>Packaging</b>	
Blister	1 pcs/pack
Inner Box	12 packs/box
Outer Carton	192 packs/carton
<b>Gross Weight:</b>	8.3 kg
<b>Volume:</b>	0.0246 cbm

#### Dimensions

Blister (mm)	84(W) x 114(H) x 18(D)
Inner Box (mm)	123(L) x 117(W) x 86(H)
Outer Carton (cm)	36.2(L) x 26.3(W) x 25.8(H)



### ER9V-BP1

9V

<b>Packaging</b>	
Blister	1 pcs/pack
Inner Box	12 packs/box
Outer Carton	192 packs/carton
<b>Gross Weight:</b>	8.3 kg
<b>Volume:</b>	0.0246 cbm

#### Dimensions

Blister (mm)	84(W) x 114(H) x 18(D)
Inner Box (mm)	123(L) x 117(W) x 86(H)
Outer Carton (cm)	36.2(L) x 26.3(W) x 25.8(H)



## Digi Alkaline Batteries

Camelion Digi Alkaline batteries are the right solution for many electronic devices including digital cameras, music players, and boom boxes. Using a new technology they offer long lasting power for high drain devices.



### LR20-BP2DG

1.5V D

<b>Packaging</b>	
Blister	2 pcs/pack
Inner Box	6 packs/box
Outer Carton	48 packs/carton
<b>Gross Weight:</b>	15.0 kg
<b>Volume:</b>	0.0157 cbm

#### Dimensions

Blister (mm)	84(W) x 114(H) x 34(D)
Inner Box (mm)	160(L) x 110(W) x 92(H)
Outer Carton (cm)	33.5(L) x 19.5(W) x 24.0(H)



### LR14-BP2DG

1.5V C

<b>Packaging</b>	
Blister	2 pcs/pack
Inner Box	6 packs/box
Outer Carton	96 packs/carton
<b>Gross Weight:</b>	14.3 kg
<b>Volume:</b>	0.0227 cbm

#### Dimensions

Blister (mm)	84(W) x 114(H) x 27(D)
Inner Box (mm)	140(L) x 90(W) x 92(H)
Outer Carton (cm)	37.5(L) x 29.5(W) x 20.5(H)



### LR6-BP4DG

1.5V AA

<b>Packaging</b>	
Blister	4 pcs/pack
Inner Box	12 packs/box
Outer Carton	144 packs/carton
<b>Gross Weight:</b>	15.4 kg
<b>Volume:</b>	0.0166 cbm

#### Dimensions

Blister (mm)	84(W) x 114(H) x 15(D)
Inner Box (mm)	131(L) x 98(W) x 86(H)
Outer Carton (cm)	27.5(L) x 28.0(W) x 21.5(H)



### LR6-BP2DG

1.5V AA

<b>Packaging</b>	
Blister	2 pcs/pack
Inner Box	12 packs/box
Outer Carton	216 packs/carton
<b>Gross Weight:</b>	12.6 kg
<b>Volume:</b>	0.0251 cbm

#### Dimensions

Blister (mm)	84(W) x 114(H) x 15(D)
Inner Box (mm)	131(L) x 98(W) x 86(H)
Outer Carton (cm)	41.5(L) x 27.5(W) x 22.0(H)



### LR03-BP4DG

1.5V AAA

<b>Packaging</b>	
Blister	4 pcs/pack
Inner Box	12 packs/box
Outer Carton	288 packs/carton
<b>Gross Weight:</b>	15.9 kg
<b>Volume:</b>	0.0237 cbm

#### Dimensions

Blister (mm)	84(W) x 114(H) x 11(D)
Inner Box (mm)	119(L) x 75(W) x 86(H)
Outer Carton (cm)	32.5(L) x 26.0(W) x 28.0(H)



### LR03-BP2DG

1.5V AAA

<b>Packaging</b>	
Blister	2 pcs/pack
Inner Box	12 packs/box
Outer Carton	288 packs/carton
<b>Gross Weight:</b>	9.1 kg
<b>Volume:</b>	0.0237 cbm

#### Dimensions

Blister (mm)	84(W) x 114(H) x 11(D)
Inner Box (mm)	119(L) x 75(W) x 86(H)
Outer Carton (cm)	32.5(L) x 26.0(W) x 28.0(H)



### 6LR61-BP1DG

9V

<b>Packaging</b>	
Blister	1 pcs/pack
Inner Box	12 packs/box
Outer Carton	192 packs/carton
<b>Gross Weight:</b>	11.2 kg
<b>Volume:</b>	0.0246 cbm

#### Dimensions

Blister (mm)	84(W) x 114(H) x 18(D)
Inner Box (mm)	123(L) x 117(W) x 86(H)
Outer Carton (cm)	36.2(L) x 26.3(W) x 25.8(H)







## Plus Alkaline Batteries

Camelion Plus Alkaline batteries offer reliable power for high drain devices. They deliver stable and long lasting current couple to a long shelf life to support high drain devices such as CD players, toys, PDAs, and electronic games.

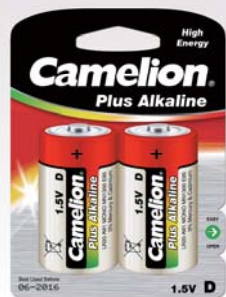

**LR20-BP2**  
**1.5V D**  
 4 260033 150004

**Packaging**  
 Blister 2 pcs/pack  
 Inner Box 6 packs/box  
 Outer Carton 48 packs/carton

**Gross Weight:** 15.0 kg  
**Volume:** 0.0157 cbm

**Dimensions**  
 Blister (mm) 84(W) x 114(H) x 34(D)  
 Inner Box (mm) 160(L) x 110(W) x 92(H)  
 Outer Carton (cm) 33.5(L) x 19.5(W) x 24.0(H)

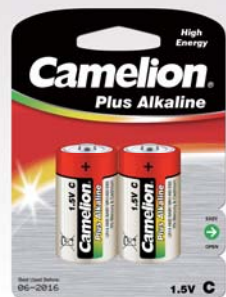

**LR14-BP2**  
**1.5V C**  
 4 260033 150011

**Packaging**  
 Blister 2 pcs/pack  
 Inner Box 6 packs/box  
 Outer Carton 96 packs/carton

**Gross Weight:** 15.6 kg  
**Volume:** 0.0227 cbm

**Dimensions**  
 Blister (mm) 84(W) x 114(H) x 27(D)  
 Inner Box (mm) 140(L) x 90(W) x 92(H)  
 Outer Carton (cm) 37.5(L) x 29.5(W) x 20.5(H)



**LR03-BP4**  
**1.5V AAA**  
 4 260033 150042

**Packaging**  
 Blister 4 pcs/pack  
 Inner Box 12 packs/box  
 Outer Carton 144 packs/carton

**Gross Weight:** 8.3 kg  
**Volume:** 0.0120 cbm

**Dimensions**  
 Blister (mm) 84(W) x 114(H) x 11(D)  
 Inner Box (mm) 119(L) x 75(W) x 86(H)  
 Outer Carton (cm) 27.5(L) x 25.5(W) x 17.0(H)



**4+4LR03**  
**1.5V AAA**  
 4 260216 451102

**Packaging**  
 Blister 8 pcs/pack  
 Inner Box 12 packs/box  
 Outer Carton 72 packs/carton

**Gross Weight:** 8.9 kg  
**Volume:** 0.0150 cbm

**Dimensions**  
 Blister (mm) 168(W) x 114(H) x 11(D)  
 Inner Box (mm) 175(L) x 130(W) x 85(H)  
 Outer Carton (cm) 41.5(L) x 19.0(W) x 19.0(H)



**LR6-BP4**  
**1.5V AA**  
 4 260033 150028

**Packaging**  
 Blister 4 pcs/pack  
 Inner Box 12 packs/box  
 Outer Carton 144 packs/carton

**Gross Weight:** 15.5 kg  
**Volume:** 0.0166 cbm

**Dimensions**  
 Blister (mm) 84(W) x 114(H) x 15(D)  
 Inner Box (mm) 131(L) x 98(W) x 86(H)  
 Outer Carton (cm) 27.5(L) x 28.0(W) x 21.5(H)

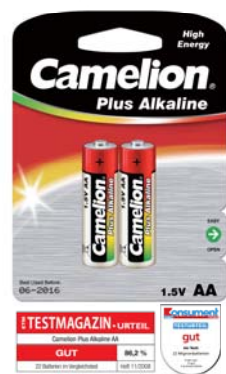

**LR6-BP2**  
**1.5V AA**  
 4 260033 150035

**Packaging**  
 Blister 2 pcs/pack  
 Inner Box 12 packs/box  
 Outer Carton 216 packs/carton

**Gross Weight:** 12.6 kg  
**Volume:** 0.0251 cbm

**Dimensions**  
 Blister (mm) 84(W) x 114(H) x 15(D)  
 Inner Box (mm) 131(L) x 98(W) x 86(H)  
 Outer Carton (cm) 41.5(L) x 27.5(W) x 22.0(H)



**LR03-BP10**  
**1.5V AAA**  
 4 260033 150103

**Packaging**  
 Blister 10 pcs/pack  
 Inner Box 12 packs/box  
 Outer Carton 72 packs/carton

**Gross Weight:** 9.4 kg  
**Volume:** 0.0152 cbm

**Dimensions**  
 Blister (mm) 84(W) x 165(H) x 11(D)  
 Inner Box (mm) 243(L) x 85(W) x 90(H)  
 Outer Carton (cm) 30.0(L) x 26.0(W) x 19.5(H)



**6LR61-BP1**  
**9V**  
 4 260033 150066

**Packaging**  
 Blister 1 pcs/pack  
 Inner Box 12 packs/box  
 Outer Carton 192 packs/carton

**Gross Weight:** 11.2 kg  
**Volume:** 0.0246 cbm

**Dimensions**  
 Blister (mm) 84(W) x 114(H) x 18(D)  
 Inner Box (mm) 123(L) x 117(W) x 86(H)  
 Outer Carton (cm) 36.2(L) x 26.3(W) x 25.8(H)



**4+4LR6**  
**1.5V AA**  
 4 260216 451096

**Packaging**  
 Blister 8 pcs/pack  
 Inner Box 12 packs/box  
 Outer Carton 72 packs/carton

**Gross Weight:** 15.5 kg  
**Volume:** 0.0199 cbm

**Dimensions**  
 Blister (mm) 168(W) x 114(H) x 15(D)  
 Inner Box (mm) 175(L) x 140(W) x 10.8(H)  
 Outer Carton (cm) 43.5(L) x 19.0(W) x 24.0(H)



**LR6-HP12**  
**1.5V AA**  
 4 260033 150424

**Packaging**  
 Blister 12 pcs/pack  
 Outer Carton 48 packs/carton

**Gross Weight:** 14.1 kg  
**Volume:** 0.0098 cbm

**Dimensions**  
 Blister (mm) 170(W) x 99(H) x 15(D)  
 Outer Carton (cm) 35.5(L) x 22.0(W) x 12.5(H)



**LR1-BP2**  
**1.5V N**  
 4 260033 150080

**Packaging**  
 Blister 2 pcs/pack  
 Inner Box 6 packs/box  
 Outer Carton 192 packs/carton

**Gross Weight:** 6.3 kg  
**Volume:** 0.0181 cbm

**Dimensions**  
 Blister (mm) 84(W) x 114(H) x 12(D)  
 Inner Box (mm) 116(L) x 45(W) x 86(H)  
 Outer Carton (cm) 36.2(L) x 25.0(W) x 20.0(H)



**3LR12-BP1**  
**4.5V**  
 4 260033 150073

**Packaging**  
 Blister 1 pcs/pack  
 Inner Box 6 packs/box  
 Outer Carton 144 packs/carton

**Gross Weight:** 16.9 kg  
**Volume:** 0.0295 cbm

**Dimensions**  
 Blister (mm) 84(W) x 114(H) x 23(D)  
 Inner Box (mm) 160(L) x 75(W) x 86(H)  
 Outer Carton (cm) 36.0(L) x 33.5(W) x 24.5(H)



**LR6-BP10**  
**1.5V AA**  
 4 260033 150097

**Packaging**  
 Blister 10 pcs/pack  
 Inner Box 12 packs/box  
 Outer Carton 72 packs/carton

**Gross Weight:** 18.8 kg  
**Volume:** 0.0239 cbm

**Dimensions**  
 Blister (mm) 84(W) x 190(H) x 15(D)  
 Inner Box (mm) 315(L) x 104(W) x 90(H)  
 Outer Carton (cm) 33.0(L) x 31.5(W) x 23.0(H)



**LR03-BP2**  
**1.5V AAA**  
 4 260033 150059

**Packaging**  
 Blister 2 pcs/pack  
 Inner Box 12 packs/box  
 Outer Carton 288 packs/carton

**Gross Weight:** 9.1 kg  
**Volume:** 0.0237 cbm

**Dimensions**  
 Blister (mm) 84(W) x 114(H) x 11(D)  
 Inner Box (mm) 119(L) x 75(W) x 86(H)  
 Outer Carton (cm) 32.5(L) x 26.0(W) x 28.0(H)



**LR6 bulk**  
**1.5V AA**

**Packaging**  
 Inner Box 60 pcs/box  
 Outer Carton 720 pcs/carton

**Gross Weight:** 17.8 kg  
**Volume:** 0.0096 cbm

**Dimensions**  
 Shrink (mm) 56(W) x 50(H) x 14(D)  
 Inner Box (mm) 174(L) x 72(W) x 50(H)  
 Outer Carton (cm) 23.5(L) x 21.5(W) x 19.0(H)



**LR6-SP4**  
**1.5V AA**  
 4 260033 150325

**Packaging**  
 Blister 4 pcs/pack  
 Inner Box 15 packs/box  
 Outer Carton 180 packs/carton

**Gross Weight:** 17.8 kg  
**Volume:** 0.0096 cbm

**Dimensions**  
 Shrink (mm) 56(W) x 50(H) x 14(D)  
 Inner Box (mm) 174(L) x 72(W) x 50(H)  
 Outer Carton (cm) 23.5(L) x 21.5(W) x 19.0(H)



**LR6-SP2**  
**1.5V AA**  
 4 260033 150332

**Packaging**  
 Blister 2 pcs/pack  
 Inner Box 20 packs/box  
 Outer Carton 360 packs/carton

**Gross Weight:** 17.9 kg  
**Volume:** 0.0100 cbm

**Dimensions**  
 Shrink (mm) 28(W) x 50(H) x 14(D)  
 Inner Box (mm) 113(L) x 72(W) x 50(H)  
 Outer Carton (cm) 31.5(L) x 23.5(W) x 13.5(H)



**LR03 bulk**  
**1.5V AA**

**Packaging**  
 Inner Box 60 pcs/box  
 Outer Carton 1200 pcs/carton

**Gross Weight:** 14.7 kg  
**Volume:** 0.0084 cbm

**Dimensions**  
 Shrink (mm) 20(W) x 44.5(H) x 10(D)  
 Inner Box (mm) 83(L) x 52(W) x 45(H)  
 Outer Carton (cm) 29.0(L) x 19.0(W) x 15.0(H)





**LR03-SP4**  
**1.5V AAA**  
 4 260033 150349

**Packaging**  
 Blister 4 pcs/pack  
 Inner Box 15 packs/box  
 Outer Carton 300 packs/carton

**Gross Weight:** 14.7 kg  
**Volume:** 0.0084 cbm

**Dimensions**  
 Shrink (mm) 40(W) x 44.5(H) x 10(D)  
 Inner Box (mm) 125(L) x 52(W) x 45(H)  
 Outer Carton (cm) 29.0(L) x 20.0(W) x 14.5(H)



**LR14-SP2**  
**1.5V C**  
 4 260033 150318

**Packaging**  
 Blister 2 pcs/pack  
 Inner Box 6 packs/box  
 Outer Carton 120 packs/carton

**Gross Weight:** 16.6 kg  
**Volume:** 0.0123 cbm

**Dimensions**  
 Shrink (mm) 52(W) x 50(H) x 26(D)  
 Inner Box (mm) 107(L) x 81(W) x 56(H)  
 Outer Carton (cm) 29.5(L) x 22.5(W) x 18.5(H)



**6LR61-SP1**  
**9V**  
 4 260033 150363

**Packaging**  
 Blister 1 pcs/pack  
 Inner Box 12 packs/box  
 Outer Carton 240 packs/carton

**Gross Weight:** 11.4 kg  
**Volume:** 0.0083 cbm

**Dimensions**  
 Shrink (mm) 25.5(W) x 48.5(H) x 17.5 (D)  
 Inner Box (mm) 105(L) x 52(W) x 50(H)  
 Outer Carton (cm) 29.0(L) x 23.0(W) x 12.5(H)



**LR6-PB24**  
**1.5V AA**  
 4 260033 150455

**Packaging**  
 Blister 24 pcs/pack  
 Outer Carton 30 packs/carton

**Gross Weight:** 18.3 kg  
**Volume:** 0.0178 cbm

**Dimensions**  
 Plastic box (mm) 98(L) x 75(W) x 50(H)  
 Outer Carton (cm) 42.5(L) x 22(W) x 19(H)



**LR03-PB24**  
**1.5V AAA**  
 4 260033 150462

**Packaging**  
 Blister 24 pcs/pack  
 Outer Carton 30 packs/carton

**Gross Weight:** 9.0 kg  
**Volume:** 0.0107 cbm

**Dimensions**  
 Plastic box (mm) 80(L) x 60(W) x 45(H)  
 Outer Carton (cm) 34.5(L) x 18.5(W) x 17.0(H)



**6LR61-PB6**  
**9V**  
 4 260033 150462

**Packaging**  
 Blister 6 pcs/pack  
 Inner Box 6 packs/box  
 Outer Carton 24 packs/carton

**Gross Weight:** 7.8 kg  
**Volume:** 0.0105 cbm

**Dimensions**  
 Plastic box (mm) 71(L) x 68(W) x 49 (H)  
 Inner Box (mm) 210(L) x 148(W) x 60(H)  
 Outer Carton (cm) 31.0(L) x 22.5(W) x 15.0(H)



**LR03-SP2**  
**1.5V AAA**  
 4 260033 150356

**Packaging**  
 Blister 2 pcs/pack  
 Inner Box 20 packs/box  
 Outer Carton 600 packs/carton

**Gross Weight:** 14.8 kg  
**Volume:** 0.0083 cbm

**Dimensions**  
 Shrink (mm) 20(W) x 44.5(H) x 10(D)  
 Inner Box (mm) 83(L) x 52(W) x 45(H)  
 Outer Carton (cm) 29.0(L) x 19.0(W) x 15.0(H)



**LR20-SP2**  
**1.5V D**  
 4 260033 150301

**Packaging**  
 Blister 2 pcs/pack  
 Inner Box 6 packs/box  
 Outer Carton 60 packs/carton

**Gross Weight:** 16.7 kg  
**Volume:** 0.0122 cbm

**Dimensions**  
 Shrink (mm) 66(W) x 61(H) x 33(D)  
 Inner Box (mm) 137(L) x 103(W) x 68(H)  
 Outer Carton (cm) 35.5(L) x 15.0(W) x 23.0(H)



**3LR12-SP1**  
**4.5V**  
 4 260033 150370

**Packaging**  
 Blister 1 pcs/pack  
 Inner Box 12 packs/box  
 Outer Carton 192 packs/carton

**Gross Weight:** 16.6 kg  
**Volume:** 0.0233 cbm

**Dimensions**  
 Shrink (mm) 62(W) x 65.5 (H) x 22 (D)  
 Inner Box (mm) 188(L) x 90(W) x 65(H)  
 Outer Carton (cm) 38.5(L) x 20.5(W) x 29.5(H)



**LR6-PB20**  
**1.5V AA**  
 4 260216 453106

**Packaging**  
 Blister 20 pcs/pack  
 Outer Carton 30 packs/carton

**Gross Weight:** 15.0 kg  
**Volume:** 0.0150 cbm

**Dimensions**  
 Plastic box (mm) 82(L) x 75(W) x 50(H)  
 Outer Carton (cm) 43.0(L) x 19.2(W) x 19.0(H)



**LR03-PB20**  
**1.5V AAA**  
 4 260216 453113

**Packaging**  
 Blister 20 pcs/pack  
 Outer Carton 30 packs/carton

**Gross Weight:** 7.8 kg  
**Volume:** 0.0074 cbm

**Dimensions**  
 Plastic box (mm) 66(L) x 64(W) x 44(H)  
 Outer Carton (cm) 34.5(L) x 15.5(W) x 17.5(H)



**LR03-PBH24**  
**1.5V AAA**  
 4 260033 155108

**Packaging**  
 Blister 24 pcs/pack  
 Inner Box 12 packs/box  
 Outer Carton 24 packs/carton

**Gross Weight:** 8.8 kg  
**Volume:** 0.0067 cbm

**Dimensions**  
 Plastic box (mm) 96(L) x 70(W) x 26(H)  
 Inner Box (mm) 21.5(L) x 200(W) x 55(H)  
 Outer Carton (cm) 23.0(L) x 21.5(W) x 13.5(H)



**LR03-PBH12**  
**1.5V AAA**  
 4 260216 453700

**Packaging**  
 Blister 12 pcs/pack  
 Inner Box 24 packs/box  
 Outer Carton 48 packs/carton

**Gross Weight:** 7.5 kg  
**Volume:** 0.0069 cbm

**Dimensions**  
 Plastic box (mm) 49(L) x 72(W) x 26(H)  
 Inner Box (mm) 150(L) x 150(W) x 110(H)  
 Outer Carton (cm) 32.0(L) x 16.5(W) x 13.0(H)



**CM-FA-01**  
 4 260033 155160

**Packaging** 10 x LR6 + 8 x LR03+  
 2 x 6LF22 + 4x C Size Adaptors+  
 4 x D Size Adaptors+BT-0503

**Gross Weight:** 8.0 kg  
**Volume:** 0.0195 cbm

**Dimensions**  
 Plastic box (mm) 255(L) x 173(W) x 37(H)  
 Outer Carton (cm) 35.5 (L) x 20.0(W) x 27.5(H)



**LR6-PBH24**  
**1.5V AA**  
 4 260033 155092

**Packaging**  
 Blister 24 pcs/pack  
 Inner Box 12 packs/box  
 Outer Carton 24 packs/carton

**Gross Weight:** 16.3 kg  
**Volume:** 0.0116 cbm

**Dimensions**  
 Plastic box (mm) 108(L) x 92(W) x 32(H)  
 Inner Box (mm) 285(L) x 220(W) x 70(H)  
 Outer Carton (cm) 30.0 (L) x 23.5(W) x 16.5(H)



**LR6-PBH12**  
**1.5V AA**  
 4 260216 453694

**Packaging**  
 Blister 12 pcs/pack  
 Inner Box 24 packs/box  
 Outer Carton 48 packs/carton

**Gross Weight:** 15.2 kg  
**Volume:** 0.0127 cbm

**Dimensions**  
 Plastic box (mm) 55(L) x 95(W) x 34(H)  
 Inner Box (mm) 195(L) x 170(W) x 142(H)  
 Outer Carton (cm) 36.5(L) x 21.0(W) x 16.5(H)



**FPA-GB28**  
 4 260216 453342

**Packaging** 12 x LR6+8 x LR03  
 +4 x LR14+4 x 6LF22  
 +key chain

**Gross Weight:** 15.6 kg  
**Volume:** 0.0203 cbm

**Dimensions**  
 Plastic box (mm) 142(L) x 108(W) x 54(H)  
 Outer Carton (cm) 35.5(L) x 30.0(W) x 19.0(H)

### Shrink Wrap Packaging and Display Boxes

Handy Packaging!

Our shrink wrap packaging and display boxes help keep your batteries where you need them, with minimum fuss.

- Convenient, portable and durable
- Self-standing, sturdy display boxes
- Many sizes and shapes available
- Securely hold several batteries
- Professional, branded card inserts and designs for effective messaging



**LR6-SP10-DA**  
**1.5V AA**  
 4 260033 157249

**Packaging**  
 Blister 10 pcs/pack  
 Inner Box 24 packs/box  
 Outer Carton 2 boxes/carton

**Gross Weight:** 14.0 kg  
**Volume:** 0.0087 cbm

**Dimensions**  
 Inner Box (mm) 150(L) x 190(W) x 108(H)  
 Outer Carton (cm) 32.0(L) x 20.5(W) x 12.5(H)



**LR03-SP10-DA**  
**1.5V AAA**  
 4 260033 157256

**Packaging**  
 Blister 10 pcs/pack  
 Inner Box 20 packs/box  
 Outer Carton 4 boxes/carton

**Gross Weight:** 12.0 kg  
**Volume:** 0.0075 cbm

**Dimensions**  
 Inner Box (mm) 110(L) x 120(W) x 96(H)  
 Outer Carton (cm) 26.0(L) x 24.0(W) x 11.0(H)



# Limited edition

## Value pack for limited campaign



**8+4LR6**  
**1.5V AA**  
4 260216 453915

**Packaging**  
Blister 6 pcs/pack  
Inner Box 12 packs/box  
Outer Carton 48 packs/carton

**Gross Weight:** 15.0 kg  
**Volume:** 0.0154 cbm

**Dimensions**  
Blister (mm) 140(W) x 114(H) x 15(D)  
Inner Box (mm) 131(L) x 98(W) x 150(H)  
Outer Carton (cm) 33.0(L) x 29.0(W) x 16.0(H)



**8+4LR03**  
**1.5V AAA**  
4 260216 453922

**Packaging**  
Blister 6 pcs/pack  
Inner Box 12 packs/box  
Outer Carton 72 packs/carton

**Gross Weight:** 11.2 kg  
**Volume:** 0.0211 cbm

**Dimensions**  
Blister (mm) 125(W) x 114(H) x 11(D)  
Inner Box (mm) 132(L) x 75(W) x 125(H)  
Outer Carton (cm) 42.5(L) x 33.5(W) x 14.8(H)



**4+2LR6**  
**1.5V AA**  
4 260216 453939

**Packaging**  
Blister 6 pcs/pack  
Inner Box 12 packs/box  
Outer Carton 72 packs/carton

**Gross Weight:** 11.8 kg  
**Volume:** 0.0154 cbm

**Dimensions**  
Blister (mm) 140(W) x 114(H) x 15(D)  
Inner Box (mm) 131(L) x 98(W) x 150(H)  
Outer Carton (cm) 33.0(L) x 29.0(W) x 16.0(H)



**4+2LR03**  
**1.5V AAA**  
4 260216 453946

**Packaging**  
Blister 6 pcs/pack  
Inner Box 12 packs/box  
Outer Carton 144 packs/carton

**Gross Weight:** 12.8 kg  
**Volume:** 0.0207 cbm

**Dimensions**  
Blister (mm) 125(W) x 114(H) x 11(D)  
Inner Box (mm) 132(L) x 75(W) x 125(H)  
Outer Carton (cm) 41.5(L) x 28.5(W) x 17.5(H)



**8+4LR6-BP**  
**1.5V AA**  
4 260216 453915

**Packaging**  
Blister 12 pcs/pack  
Inner Box 6 packs/box  
Outer Carton 48 packs/carton

**Gross Weight:** 15 kg  
**Volume:** 0.0190 cbm

**Dimensions**  
Blister (mm) 125(W) x 114(H) x 29(D)  
Inner Box (mm) 132(L) x 100(W) x 137(H)  
Outer Carton (cm) 29.5(L) x 28.5(W) x 22.5(H)



**4+2LR6-BP**  
**1.5V AA**  
4 260216 453939

**Packaging**  
Blister 6 pcs/pack  
Inner Box 12 packs/box  
Outer Carton 72 packs/carton

**Gross Weight:** 11.8 kg  
**Volume:** 0.0160 cbm

**Dimensions**  
Blister (mm) 125(W) x 114(H) x 15(D)  
Inner Box (mm) 132(L) x 105(W) x 138(H)  
Outer Carton (cm) 41.5(L) x 29.5(W) x 13.0(H)



**8+4LR03-BP**  
**1.5V AAA**  
4 260216 453922

**Packaging**  
Blister 12 pcs/pack  
Inner Box 6 packs/box  
Outer Carton 72 packs/carton

**Gross Weight:** 12.2 kg  
**Volume:** 0.0207 cbm

**Dimensions**  
Blister (mm) 125(W) x 114(H) x 21(D)  
Inner Box (mm) 132(L) x 75(W) x 125(H)  
Outer Carton (cm) 41.5(L) x 28.5(W) x 17.5(H)



**4+2LR03-BP**  
**1.5V AAA**  
4 260216 453946

**Packaging**  
Blister 6 pcs/pack  
Inner Box 12 packs/box  
Outer Carton 144 packs/carton

**Gross Weight:** 12.8 kg  
**Volume:** 0.0207 cbm

**Dimensions**  
Blister (mm) 125(W) x 114(H) x 11(D)  
Inner Box (mm) 132(L) x 75(W) x 125(H)  
Outer Carton (cm) 41.5(L) x 28.5(W) x 17.5(H)



**LR6-SP8**  
**1.5V AA**  
4 260216 451003

**Packaging**  
Blister 8 pcs/pack  
Inner Box 20 packs/box  
Outer Carton 4 boxes/carton

**Gross Weight:** 15.5 kg  
**Volume:** 0.0099 cbm

**Dimensions**  
Inner Box (mm) 150(L) x 118(W) x 110(H)  
Outer Carton (cm) 25.0(L) x 16.5(W) x 24.0(H)



**LR03-SP8**  
**1.5V AAA**  
4 260216 451010

**Packaging**  
Blister 8 pcs/pack  
Inner Box 40 packs/box  
Outer Carton 4 boxes/carton

**Gross Weight:** 15.5 kg  
**Volume:** 0.0096 cbm

**Dimensions**  
Inner Box (mm) 170(L) x 110(W) x 100(H)  
Outer Carton (cm) 23.5(L) x 18.5(W) x 22.0(H)



**LR14-SP6**  
**1.5V C**  
4 260216 453663

**Packaging**  
Blister 6 pcs/pack  
Inner Box 10 packs/box  
Outer Carton 4 boxes/carton

**Gross Weight:** 16.7 kg  
**Volume:** 0.0119 cbm

**Dimensions**  
Inner Box (mm) 158(L) x 135(W) x 110(H)  
Outer Carton (cm) 28.5(L) x 17.3(W) x 24.0(H)



**LR20-SP6**  
**1.5V D**  
4 260216 45365 6

**Packaging**  
Blister 6 pcs/pack  
Inner Box 10 packs/box  
Outer Carton 2 boxes/carton

**Gross Weight:** 16.8kg  
**Volume:** 0.0117 cbm

**Dimensions**  
Inner Box (mm) 203(L) x 172(W) x 130(H)  
Outer Carton (cm) 35.8(L) x 21.8(W) x 15.0(H)



**LR6-SP16**  
**1.5V AA**  
4 260216 451072

**Packaging**  
Blister 16 pcs/pack  
Inner Box 10 packs/box  
Outer Carton 4 boxes/carton

**Gross Weight:** 15.5 kg  
**Volume:** 0.0099 cbm

**Dimensions**  
Inner Box (mm) 150(L) x 118(W) x 110(H)  
Outer Carton (cm) 25.0(L) x 16.5(W) x 24.0(H)



**LR03-SP16**  
**1.5V AAA**  
4 260216 453670

**Packaging**  
Blister 16 pcs/pack  
Inner Box 20 packs/box  
Outer Carton 4 boxes/carton

**Gross Weight:** 15.5 kg  
**Volume:** 0.0096 cbm

**Dimensions**  
Inner Box (mm) 170(L) x 110(W) x 100(H)  
Outer Carton (cm) 23.5(L) x 18.5(W) x 22.0(H)



**LR20-PB4**  
**1.5V D**  
4 260033 150431

**Packaging**  
Blister 4 pcs/pack  
Inner Box 6 packs/box  
Outer Carton 24 packs/carton

**Gross Weight:** 14.8 kg  
**Volume:** 0.0191 cbm

**Dimensions**  
Plastic box (mm) 89(L) x 84(W) x 62 (H)  
Inner Box (mm) 260(L) x 185(W) x 75(H)  
Outer Carton (cm) 38.5(L) x 27.5(W) x 18.0(H)



**LR14-PB4**  
**1.5V C**  
4 260033 150448

**Packaging**  
Blister 4 pcs/pack  
Inner Box 6 packs/box  
Outer Carton 24 packs/carton

**Gross Weight:** 7.6 kg  
**Volume:** 0.0112 cbm

**Dimensions**  
Plastic box (mm) 73(L) x 68(W) x 50(H)  
Inner Box (mm) 210(L) x 152(W) x 61(H)  
Outer Carton (cm) 32.0(L) x 22.5(W) x 15.5(H)





## Super Heavy Duty Batteries

Camelion Zinc Carbon batteries are a great choice for small household electronic devices that need continuous power such as clocks, flashlights, remote controls and transistor radios. Manganese dioxide is used for the positive material and zinc/ammonium chloride for the electrolyte in a leakage proof structure. These, general purpose, batteries offer a long shelf life as well as reliability, versatility and savings.



**R20P-BP2B**  
**1.5V D**  
 Packaging 4 260033 151018  
 Blister 2 pcs/pack Gross Weight: 14.9 kg  
 Inner Box 6 packs/box Volume: 0.0238 cbm  
 Outer Carton 72 packs/carton  
 Dimensions  
 Blister (mm) 84(W) x 114(H) x 34(D)  
 Inner Box (mm) 160(L) x 110(W) x 92(H)  
 Outer Carton (cm) 33.5(L) x 29.0(W) x 24.5(H)



**R6P-BP4B**  
**1.5V AA**  
 Packaging 4 260033 151049  
 Blister 4 pcs/pack Gross Weight: 17.5 kg  
 Inner Box 12 packs/box Volume: 0.0272cbm  
 Outer Carton 240 packs/carton  
 Dimensions  
 Blister (mm) 84(W) x 114(H) x 15(D)  
 Inner Box (mm) 131(L) x 98(W) x 86(H)  
 Outer Carton (cm) 45.0(L) x 27.5(W) x 22.0(H)



**R6P-HP12B**  
**4.5V**  
 Packaging 4 260033 151438  
 Blister 12 pcs/pack Gross Weight: 9.3 kg  
 Outer Carton 48 packs/carton Volume: 0.0098cbm  
 Dimensions  
 Blister (mm) 70(W) x 65(H) x 50(D)  
 Outer Carton (cm) 40.0(L) x 16.0(W) x 17.5(H)



**R6P-SP4B**  
**1.5V AA**  
 Packaging 4 260033 151339  
 Blister 4 pcs/pack Gross Weight: 18.5 kg  
 Inner Box 12 packs/box Volume: 0.0161cbm  
 Outer Carton 240 packs/carton  
 Dimensions  
 Shrink (mm) 56(W) x 50(H) x 14(D)  
 Inner Box (mm) 118(L) x 92(W) x 56(H)  
 Outer Carton (cm) 30.5(L) x 19.5(W) x 27.0(H)



**4R25-SP1B**  
**6V**  
 Packaging 4 260033 153531  
 Blister 1 pcs/pack Gross Weight: 6.7 kg  
 Inner Box 6 packs/box Volume: 0.0090 cbm  
 Outer Carton 12 packs/carton  
 Dimensions  
 Shrink (mm) 68.2(W) x 68.2(H) x 115 (D)  
 Inner Box (mm) 205(L) x 135(W) x 120(H)  
 Outer Carton (cm) 29.0(L) x 22.0(W) x 14.0(H)



**R14P-BP2B**  
**1.5V C**  
 Packaging 4 260033 151025  
 Blister 2 pcs/pack Gross Weight: 15.6 kg  
 Inner Box 6 packs/box Volume: 0.0315 cbm  
 Outer Carton 144 packs/carton  
 Dimensions  
 Blister (mm) 84(W) x 114(H) x 27(D)  
 Inner Box (mm) 137(L) x 86(W) x 86(H)  
 Outer Carton (cm) 37.5(L) x 29.5(W) x 28.5(H)



**R03P-BP4B**  
**1.5V AAA**  
 Packaging 4 260033 151070  
 Blister 4 pcs/pack Gross Weight: 14.6 kg  
 Inner Box 12 packs/box Volume: 0.0237cbm  
 Outer Carton 288 packs/carton  
 Dimensions  
 Blister (mm) 84(W) x 114(H) x 11(D)  
 Inner Box (mm) 119(L) x 75(W) x 86(H)  
 Outer Carton (cm) 32.5(L) x 26.0(W) x 28.0(H)



**6F22-BP1B**  
**9V**  
 Packaging 4 260033 151094  
 Blister 1 pcs/pack Gross Weight: 11.4 kg  
 Inner Box 12 packs/box Volume: 0.0310 cbm  
 Outer Carton 240 packs/carton  
 Dimensions  
 Blister (mm) 84(W) x 114(H) x 18(D)  
 Inner Box (mm) 123(L) x 117(W) x 86(H)  
 Outer Carton (cm) 45.0(L) x 27.0(W) x 25.5(H)



**R03P-SP4B**  
**1.5V AAA**  
 Packaging 4 260033 151353  
 Blister 4 pcs/pack Gross Weight: 14.2 kg  
 Inner Box 24 packs/box Volume: 0.0139 cbm  
 Outer Carton 480 packs/carton  
 Dimensions  
 Shrink (mm) 40(W) x 44.5(H) x 10(D)  
 Inner Box (mm) 126(L) x 86(W) x 50(H)  
 Outer Carton (cm) 36.0(L) x 26.5(W) x 14.5(H)



**R20P-BP2G**  
**1.5V D**  
 Packaging 4 260033 156280  
 Blister 2 pcs/pack Gross Weight: 14.1 kg  
 Inner Box 6 packs/box Volume: 0.0238cbm  
 Outer Carton 72 packs/carton  
 Dimensions  
 Blister (mm) 84(W) x 114(H) x 34(D)  
 Inner Box (mm) 160(L) x 110(W) x 92(H)  
 Outer Carton (cm) 33.5(L) x 29.0(W) x 24.5(H)



**R14P-BP2G**  
**1.5V C**  
 Packaging 4 260033 156297  
 Blister 2 pcs/pack Gross Weight: 14.3 kg  
 Inner Box 6 packs/box Volume: 0.0315 cbm  
 Outer Carton 144 packs/carton  
 Dimensions  
 Blister (mm) 84(W) x 114(H) x 27(D)  
 Inner Box (mm) 137(L) x 86(W) x 86(H)  
 Outer Carton (cm) 37.5(L) x 29.5(W) x 28.5(H)



**R14P-BP6G**  
**1.5V C**  
 Packaging 4 260033 150936  
 Blister 6 pcs/pack Gross Weight: 15 kg  
 Inner Box 4 packs/box Volume: 0.0336 cbm  
 Outer Carton 48 packs/carton  
 Dimensions  
 Blister (mm) 84(W) x 210(H) x 27(D)  
 Inner Box (mm) 220(L) x 110(W) x 90(H)  
 Outer Carton (cm) 46.5(L) x 24.5(W) x 29.5(H)



**R6P-BP4G**  
**1.5V AA**  
 Packaging 4 260033 156303  
 Blister 4 pcs/pack Gross Weight: 13.7 kg  
 Inner Box 12 packs/box Volume: 0.0272cbm  
 Outer Carton 240 packs/carton  
 Dimensions  
 Blister (mm) 84(W) x 114(H) x 15(D)  
 Inner Box (mm) 131(L) x 98(W) x 86(H)  
 Outer Carton (cm) 45.0(L) x 27.5(W) x 22.0(H)



**R03P-BP4G**  
**1.5V AAA**  
 Packaging 4 260033 156327  
 Blister 4 pcs/pack Gross Weight: 12.0 kg  
 Inner Box 12 packs/box Volume: 0.0237cbm  
 Outer Carton 288 packs/carton  
 Dimensions  
 Blister (mm) 84(W) x 114(H) x 11(D)  
 Inner Box (mm) 119(L) x 75(W) x 86(H)  
 Outer Carton (cm) 32.5(L) x 26.0(W) x 28.0(H)



**R20P-BP4G**  
**1.5V D**  
 Packaging 4 260033 156358  
 Blister 4 pcs/pack Gross Weight: 20.6 kg  
 Inner Box 6 packs/box Volume: 0.0340cbm  
 Outer Carton 54 packs/carton  
 Dimensions  
 Blister (mm) 84(W) x 190(H) x 34(D)  
 Inner Box (mm) 290(L) x 110(W) x 90(H)  
 Outer Carton (cm) 31.0(L) x 30.5(W) x 36.0(H)



**R14P-BP4G**  
**1.5V C**  
 Packaging 4 260033 156389  
 Blister 4 pcs/pack Gross Weight: 10.4 kg  
 Inner Box 6 packs/box Volume: 0.0245cbm  
 Outer Carton 54 packs/carton  
 Dimensions  
 Blister (mm) 84(W) x 165(H) x 27(D)  
 Inner Box (mm) 240(L) x 90(W) x 90(H)  
 Outer Carton (cm) 32.0(L) x 25.5(W) x 30.0(H)



**R6P-BP8G**  
**1.5V AA**  
 Packaging 4 260033 156402  
 Blister 8 pcs/pack Gross Weight: 9.5 kg  
 Inner Box 12 packs/box Volume: 0.0198 cbm  
 Outer Carton 72 packs/carton  
 Dimensions  
 Blister (mm) 84(W) x 165(H) x 15(D)  
 Inner Box (mm) 265(L) x 100(W) x 90(H)  
 Outer Carton (cm) 31.5(L) x 28.0(W) x 22.5(H)



**R6P-BP10G**  
**1.5V AA**  
 Packaging 4 260033 156396  
 Blister 10 pcs/pack Gross Weight: 12.1 kg  
 Inner Box 12 packs/box Volume: 0.0239 cbm  
 Outer Carton 72 packs/carton  
 Dimensions  
 Blister (mm) 84(W) x 190(H) x 15(D)  
 Inner Box (mm) 315(L) x 104(W) x 90(H)  
 Outer Carton (cm) 33.0(L) x 31.5(W) x 23.0(H)



**R03P-BP8G**  
**1.5V AAA**  
 Packaging 4 260033 156426  
 Blister 8 pcs/pack Gross Weight: 6.6 kg  
 Inner Box 12 packs/box Volume: 0.0132 cbm  
 Outer Carton 72 packs/carton  
 Dimensions  
 Blister (mm) 84(W) x 165(H) x 11(D)  
 Inner Box (mm) 200(L) x 84(W) x 90(H)  
 Outer Carton (cm) 30.0(L) x 22.0(W) x 20.0(H)





**6F22-BP1G**  
**9V**  
 4 260033 156341  
 Packaging Blister 1 pcs/pack Gross Weight: 11.4 kg  
 Inner Box 12 packs/box Volume:  
 Outer Carton 240 packs/carton 0.0310 cbm  
 Dimensions  
 Blister (mm) 84(W) x 114(H) x 18(D)  
 Inner Box (mm) 123(L) x 117(W) x 86(H)  
 Outer Carton (cm) 45.0(L) x 27.0(W) x 25.5(H)

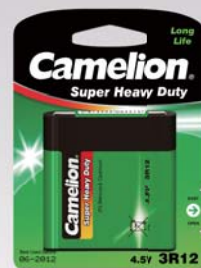

**3R12-BP1G**  
**4.5V**  
 4 260033 156372  
 Packaging Blister 1 pcs/pack Gross Weight: 17.6 kg  
 Inner Box 6 packs/box Volume:  
 Outer Carton 144 packs/carton 0.0290cbm  
 Dimensions  
 Blister (mm) 84(W) x 114(H) x 23(D)  
 Inner Box (mm) 160(L) x 75(W) x 86(H)  
 Outer Carton (cm) 33.5(L) x 31.5(W) x 27.5(H)



**2R10-BP1G**  
**3V**  
 4 260033 150943  
 Packaging Blister 2 pcs/pack Gross Weight: 11.0 kg  
 Inner Box 12 packs/box Volume:  
 Outer Carton 240 packs/carton 0.0533 cbm  
 Dimensions  
 Blister (mm) 84(W) x 124(H) x 14(D)  
 Inner Box (mm) 156(L) x 115(W) x 125(H)  
 Outer Carton (cm) 59.5(L) x 28.0(W) x 32.0(H)



**R20P-SP2G**  
**1.5V D**  
 4 260033 156433  
 Packaging Blister 2 pcs/pack Gross Weight: 17.5 kg  
 Inner Box 6 packs/box Volume:  
 Outer Carton 96 packs/carton 0.0169 cbm  
 Dimensions  
 Shrink (mm) 66(W) x 61(H) x 33(D)  
 Inner Box (mm) 137(L) x 103(W) x 68(H)  
 Outer Carton (cm) 28.5(L) x 22.0(W) x 27.0(H)



**R14P-SP2G**  
**1.5V C**  
 4 260033 156440  
 Packaging Blister 2 pcs/pack Gross Weight: 13.2 kg  
 Inner Box 6 packs/box Volume:  
 Outer Carton 144 packs/carton 0.0129 cbm  
 Dimensions  
 Shrink (mm) 52(W) x 50(H) x 26(D)  
 Inner Box (mm) 104(L) x 78(W) x 50(H)  
 Outer Carton (cm) 25.5(L) x 23.0(W) x 22.0(H)



**R6P-SP2G**  
**1.5V AA**  
 4 260033 156464  
 Packaging Blister 2 pcs/pack Gross Weight: 15.5 kg  
 Inner Box 30 packs/box Volume:  
 Outer Carton 480 packs/carton 0.0127cbm  
 Dimensions  
 Shrink (mm) 28(W) x 50(H) x 14(D)  
 Inner Box (mm) 113(L) x 72(W) x 50(H)  
 Outer Carton (cm) 30.5(L) x 22.0(W) x 19.0(H)



**FPG-GB40**  
 4 260033 150905  
 Packaging 4x R14P + 24 x R6P+ Gross Weight: 13.0 kg  
 12 x R03P+ 13.0 kg  
 1 x SL3013(Blue 3LR44) Volume:  
 Outer Carton 18 boxes/carton 0.0223 cbm  
 Dimensions  
 Plastic box (mm)  
 Outer Carton (cm) 40.0 (L) x 28.0(W) x 19.5(H)



**R6P-SP4G**  
**1.5V AA**  
 4 260033 156457  
 Packaging Blister 4 pcs/pack Gross Weight: 14.7 kg  
 Inner Box 15 packs/box Volume:  
 Outer Carton 240 packs/carton 0.0127cbm  
 Dimensions  
 Shrink (mm) 56(W) x 50(H) x 14(D)  
 Inner Box (mm) 174(L) x 72(W) x 50(H)  
 Outer Carton (cm) 30.5(L) x 22.0(W) x 19.0(H)



**R6P-SP5G**  
**1.5V AA**  
 4 260033 157478  
 Packaging Blister 5 pcs/pack Gross Weight: 11.3 kg  
 Inner Box 12 packs/box Volume:  
 Outer Carton 144 packs/carton 0.0096 cbm  
 Dimensions  
 Shrink (mm) 68(W) x 50(H) x 14(D)  
 Inner Box (mm) 167(L) x 72(W) x 50(H)  
 Outer Carton (cm) 23.5(L) x 21.5(W) x 19(H)



**R03P-SP2G**  
**1.5V AAA**  
 4 260033 156488  
 Packaging Blister 2 pcs/pack Gross Weight: 9.5 kg  
 Inner Box 30 packs/box Volume:  
 Outer Carton 600 packs/carton 0.0083 cbm  
 Dimensions  
 Shrink (mm) 40(W) x 44.5(H) x 10(D)  
 Inner Box (mm) 83(L) x 52(W) x 45(H)  
 Outer Carton (cm) 28.5(L) x 20.0(W) x 14.5(H)



**R03P-SP4G**  
**1.5V AAA**  
 4 260033 156471  
 Packaging Blister 4 pcs/pack Gross Weight: 10.0 kg  
 Inner Box 15 packs/box Volume:  
 Outer Carton 300 packs/carton 0.0083 cbm  
 Dimensions  
 Shrink (mm) 40(W) x 44.5(H) x 10(D)  
 Inner Box (mm) 125(L) x 52(W) x 45(H)  
 Outer Carton (cm) 28.5(L) x 20.0(W) x 14.5(H)



**6F22-SP1G**  
**9V**  
 4 260033 156495  
 Packaging Blister 1 pcs/pack Gross Weight: 19.0 kg  
 Inner Box 12 packs/box Volume:  
 Outer Carton 480 packs/carton 0.0144 cbm  
 Dimensions  
 Shrink (mm) 25.5(W) x 48.5(H) x 17.5 (D)  
 Inner Box (mm) 105(L) x 52(W) x 50(H)  
 Outer Carton (cm) 29.0(L) x 22.5(W) x 22.0(H)



**3R12-SP1G**  
**4.5V**  
 4 260033 156501  
 Packaging Blister 1 pcs/pack Gross Weight: 16.6 kg  
 Inner Box 12 packs/box Volume:  
 Outer Carton 144 packs/carton 0.0188 cbm  
 Dimensions  
 Shrink (mm) 62(W) x 65.5 (H) x 22 (D)  
 Inner Box (mm) 188(L) x 90(W) x 65(H)  
 Outer Carton (cm) 39.0(L) x 21.0(W) x 23.0(H)



**4R25-SP1G**  
**6V**  
 4 260033 156211  
 Packaging Blister 1 pcs/pack Gross Weight: 6.7 kg  
 Inner Box 6 packs/box Volume:  
 Outer Carton 12 packs/carton 0.0090 cbm  
 Dimensions  
 Shrink (mm) 68.5(W) x 68.5(H) x 115 (D)  
 Inner Box (mm) 205(L) x 135(W) x 120(H)  
 Outer Carton (cm) 29.0(L) x 22.0(W) x 14.0(H)

## Shrink Wrap Packaging and Display Boxes

### Handy Packaging!

Our shrink wrap packaging and display boxes help keep your batteries where you need them, with minimum fuss.

- Convenient, portable and durable
- Self-standing, sturdy display boxes
- Many sizes and shapes available
- Securely hold several batteries
- Professional, branded card inserts and designs for effective messaging



**R6P-SP8G**  
**1.5V AA**  
 4 260216 451188

Packaging		Gross Weight:	
Blister	8 pcs/pack		14.7 kg
Inner Box	20 packs/box	Volume:	
Outer Carton	6 boxes/carton		0.0147 cbm
Dimensions			
Inner Box (mm)	150(L) x 118(W) x 110(H)		
Outer Carton (cm)	34.5(L) x 25.0(W) x 17.0(H)		



**R6P-SP12G**  
**1.5V AA**  
 4 260033 156266

Packaging		Gross Weight:	
Blister	12 pcs/pack		16.5 kg
Inner Box	20 packs/box	Volume:	
Outer Carton	4 boxes/carton		0.0127 cbm
Dimensions			
Inner Box (mm)	175(L) x 150(W) x 110(H)		
Outer Carton (cm)	31.5(L) x 19.0(W) x 24.0(H)		



**R03P-SP8G**  
**1.5V AAA**  
 4 260216 451171

Packaging		Gross Weight:	
Blister	8 pcs/pack		15.3 kg
Inner Box	40 packs/box	Volume:	
Outer Carton	6 boxes/carton		0.0141 cbm
Dimensions			
Inner Box (mm)	170(L) x 110(W) x 100(H)		
Outer Carton (cm)	31.5(L) x 23.5(W) x 19.0(H)		

## Photo Lithium Batteries

Camelion Photo batteries are ideal for a wide range of analog cameras.



**CR123A-BP1**  
**3V**  
 4 260033 153364

Packaging		Gross Weight:	
Blister	1 pcs/pack		5.5 kg
Inner Box	10 packs/box	Volume:	
Outer Carton	200 packs/carton		0.0243 cbm
Dimensions			
Blister (mm)	84(W) x 114(H) x 17.5(D)		
Inner Box (mm)	118(L) x 95(W) x 85(H)		
Outer Carton (cm)	45.0(L) x 25.0(W) x 21.5(H)		



**CR2-BP1**  
**3V**  
 4 260033 153388

Packaging		Gross Weight:	
Blister	1 pcs/pack		4.5 kg
Inner Box	10 packs/box	Volume:	
Outer Carton	200 packs/carton		0.0215 cbm
Dimensions			
Blister (mm)	84(W) x 114(H) x 16.5(D)		
Inner Box (mm)	118(L) x 85(W) x 85(H)		
Outer Carton (cm)	45.0(L) x 25.0(W) x 19.0(H)		



**CR-P2-BP1**  
**6V**  
 4 260033 153371

Packaging		Gross Weight:	
Blister	1 pcs/pack		10.0 kg
Inner Box	10 packs/box	Volume:	
Outer Carton	200 packs/carton		0.0265 cbm
Dimensions			
Blister (mm)	84(W) x 114(H) x 20.5(D)		
Inner Box (mm)	118(L) x 105(W) x 85(H)		
Outer Carton (cm)	45.0(L) x 25.0(W) x 23.5(H)		



**2CR5-BP1**  
**6V**  
 4 260033 153395

Packaging		Gross Weight:	
Blister	1 pcs/pack		10.0 kg
Inner Box	10 packs/box	Volume:	
Outer Carton	200 packs/carton		0.0265 cbm
Dimensions			
Blister (mm)	84(W) x 114(H) x 18(D)		
Inner Box (mm)	118(L) x 105(W) x 85(H)		
Outer Carton (cm)	45.0(L) x 25.0(W) x 23.5(H)		



## Electronic Button Cells

Camelion Electronic Button Cells provide stable energy for small electronic devices and are available in lithium, alkaline, silver oxide and zinc air chemistries, depending upon voltage and size requirements of your equipment. They are suitable for car keys, calculators, laser points, hearing aids and many other electronic gadgets.



### Electronics Lithium 3V



ITEM	EAN	PACKAGING WxHxD(mm)	INNER BOX LxWxH(mm)	SHIPPING CARTON LxWxH(cm)	G.W.(KG)	VOLUME(CBM)				
CR1216-BP1	4260033152831	56 x 92 x 3 1 PC / BLISTER	98 x 37 x 58 10 PACKS	45.5 x 31.5 x 31.5 1800 PACKS	9.5	0.0451				
CR1220-BP1	4260033152824				8.0					
CR1225-BP1	4260033152817				8.0					
CR1616-BP1	4260033152800				8.0					
CR1620-BP1	4260033152794				8.5					
CR1632-BP1	4260033152923				10.4					
CR2016-BP1	4260033152787				11.0					
CR2025-BP1	4260033152770				12.0					
CR2032-BP1	4260033152763				11.5					
CR2320-BP1	4260033152756				13.0					
CR2330-BP1	4260033152749				13.5					
CR2430-BP1	4260033152732				17.5					
CR2450-BP1	4260033152725				14.0					
CR927-BP1	4260216452475									
CR1216-BP5	4260033152718	55x 190 x 3 5 PCS / BLISTER	195 x 90 x 58 30 PACKS	29.0 x 22.0 x 26.0 360 PACKS	4.5	0.0165				
CR1220-BP5	4260033152701				4.5					
CR1225-BP5	4260033152695				5.0					
CR1616-BP5	4260033152688				5.5					
CR1620-BP5	4260033152671				5.5					
CR2016-BP5	4260033152664				6.5					
CR2025-BP5	4260033152657				8.0					
CR2032-BP5	4260033152640				9.0					

### Electronics Alkaline 1.5V



ITEM	EAN	PACKAGING WxHxD(mm)	INNER BOX LxWxH(mm)	SHIPPING CARTON LxWxH(cm)	G.W.(KG)	VOLUME (CBM)
AG1-BP2	4260033153074	56 x 92 x 5 2 PC / BLISTER	95 x 63 x 58 20 PACKS	39.5 x 30.5 x 31.5 1800 PACKS	7.0	0.0379
AG2-BP2	4260033153081				7.8	
AG3-BP2	4260033153098				8.0	
AG4-BP2	4260033153104				7.0	
AG5-BP2	4260033153111	56 x 92 x 7 2 PC / BLISTER	98 x 73 x 58 20 PACKS	45.5 x 31.5 x 31.5 1800 PACKS	9.0	0.0451
AG6-BP2	4260033153128				8.0	
AG7-BP2	4260033153135	56 x 92 x 5 2 PC / BLISTER	95 x 63 x 58 20 PACKS	39.5 x 30.5 x 31.5 1800 PACKS	8.5	0.0379
AG8-BP2	4260033153142				9.0	
AG9-BP2	4260033153159				9.0	
AG10-BP2	4260033153166				10.0	
AG11-BP2	4260033153173	56 x 92 x 7 2 PC / BLISTER	98 x 73 x 58 20 PACKS	45.5 x 31.5 x 31.5 1800 PACKS	7.0	0.0451
AG12-BP2	4260033153180				11.0	
AG13-BP2	4260033153197				13.0	
625A	4260033153234				18.0	
AG0-BP10	4260033153203	50x 160 x 5 10 PCS / BLISTER	170 x 90 x 52 20 PACKS	50.0 x 20.0 x 20.0 360 PACKS	4.0	0.0198
AG1-BP10	4260033152947				4.0	
AG2-BP10	4260033152954				4.5	
AG3-BP10	4260033152961				5.0	
AG4-BP10	4260033152978				4.0	
AG5-BP10	4260033152985				6.5	
AG6-BP10	4260033152992				5.0	
AG7-BP10	4260033153005				5.5	
AG8-BP10	4260033153012				6.0	
AG9-BP10	4260033153029				6.0	
AG10-BP10	4260033153036				7.0	
AG11-BP10	4260033153043				4.0	
AG12-BP10	4260033153050				8.7	
AG13-BP10	4260033153067	10.0				

## Industrial Classifications

AG0	LR521	G0			379
AG1	LR621	G1	LR60	164	364
AG2	LR726	G2	LR59	196	396
AG3	LR41	G3	LR41	192	392
AG4	LR626	G4	LR66	177	377
AG5	LR754	G5	LR48	193	393
AG6	LR921	G6	LR69	171	371
AG7	LR926	G7	LR57	195	395
AG8	LR1120	G8	LR55	191	391
AG9	LR936	G9	LR45	194	394
AG10	LR1130	G10	LR54	189	389
AG11	LR721	G11	LR58	162	362
AG12	LR43	G12	LR43	186	386
AG13	LR44	G13	LR44	A76	357

### Remote Control Batteries 12V/6V



ITEM	EAN	PACKAGING WxHxD(mm)	INNER BOX LxWxH(mm)	SHIPPING CARTON LxWxH(cm)	G.W.(KG)	VOLUME (CBM)
A11-BP1	4260216452772	56 x 92 x 10 1 PC / BLISTER	125 x 95 x 58 20 PACKS	39.5 x 30.5 x 31.5 900 PACKS	7.6	0.0380
A23-BP1	4260033153326				8.6	
A27-BP1	4260033153333				8.0	
A32-BP1	4260033153340				7.1	
A23-BP5	4260033153302	50x 160 x 10 5 PCS / BLISTER	170 x 65 x 52 10 PACKS	42.0 x 36.0 x 18.0 360 PACKS	18.0	0.0272
A27-BP5	4260033153319				12.0	



#### 4LR44-BP1C

6V



4 260033 153456

**Packaging**  
 Blister 1 pcs/pack  
 Inner Box 20 packs/box  
 Outer Carton 900 packs/carton

**Dimensions**  
 Blister (mm) 56(W)x 92(H) x 15(D)  
 Inner Box (mm) 145(L)x 98(W) x 58(H)  
 Outer Carton (cm) 45.5(L)x 31.5(W) x 31.5(H)

**Gross Weight:** 15 kg  
**Volume:** 0.0451 cbm



#### 4SR44-BP1C

6V



4 260033 153470

**Packaging**  
 Blister 1 pcs/pack  
 Inner Box 20 packs/box  
 Outer Carton 900 packs/carton

**Dimensions**  
 Blister (mm) 56(W)x 92(H) x 15(D)  
 Inner Box (mm) 145(L)x 98(W) x 58(H)  
 Outer Carton (cm) 45.5(L)x 31.5(W) x 31.5(H)

**Gross Weight:** 15 kg  
**Volume:** 0.0451 cbm

## Industrial Classifications

SG0	SR521	G0	SR63	379
SG1	SR621	G1	SR60	364
SG2	SR726	G2	SR59	396
SG3	SR41	G3	SR41	392
SG4	SR626	G4	SR66	377
SG5	SR754	G5	SR48	393
SG6	SR921	G6	SR69	371
SG7	SR926	G7	SR57	395
SG8	SR1120	G8	SR55	391
SG9	SR936	G9	SR45	394
SG10	SR1130	G10	SR54	389
SG11	SR721	G11	SR58	362
SG12	SR43	G12	SR43	386
SG13	SR44	G13	SR44	357



## Electronics Silver Oxide 1.55V



ITEM	EAN	PACKAGING WxHxD(mm)	INNER BOX LxWxH(mm)	SHIPPING CARTON LxWxH(cm)	G.W.(KG)	VOLUME(CBM)
SR41W-BP1	4260033152442	55x 92 x 5 1 PC / BLISTER	145 x 95 x 58 40 PACKS	45.5 x 31.5 x 31.5 1800 PACKS	8.5	0.0451
SR43-BP1	4260033152503				10.5	
SR44-BP1	4260033152510				11.5	
SR54-BP1	4260033152527				9.5	
SR57W-BP1	4260033152541				8.5	
SR58W-BP1	4260033152459				8	
SR59W-BP1	4260033152466				8	
SR60W-BP1	4260033152473				8	
SR63W-BP1	4260033152480				7.5	
SR66W-BP1	4260033152497				8	
SR69W-BP1	4260033152534	9.5				
SR41W-BP5	4260033152343	55x 190 x 5 5 PCS / BLISTER	195 x 90 x 58 20 PACKS	37.0 x 21.7 x 29.5 360 PACKS	4.5	0.0237
SR43-BP5	4260033152404				6.5	
SR44-BP5	4260033152411				7.5	
SR54-BP5	4260033152428				5.5	
SR57W-BP5	4260216453588				4.5	
SR58W-BP5	4260033152350				4	
SR59W-BP5	4260033152367				4	
SR60W-BP5	4260033152374				4	
SR63W-BP5	4260033152381				3.5	
SR66W-BP5	4260033152398				4	
SR69W-BP5	4260033152435	5.5				

## Zinc Air 1.4V

Camelion Zinc Air batteries are light and reliable. They are conveniently packaged to make them easy to use.



ITEM	EAN	PACKAGING WxHxD(mm)	INNER BOX WxHxD(mm)	INNER CARTON WxHxD(mm)	SHIPPING CARTON WxHxD(cm)	G.W.(KG)	VOLUME (CBM)				
A13-BP6	4260033151971	48 x 90 x 3	6PCS/Blister	92 x 42 x 5	10Packs	245 x 120 x 130	100Packs	62 x 26 x 15	500Packs	5.3	0.0242
A10-BP6	4260033151988	48 x 90 x 4	6PCS/Blister	92 x 42 x 5	10Packs	195 x 120 x 130	100Packs	62 x 22 x 15	500Packs	3.5	0.0205
A675-BP6	4260033151964	48 x 90 x 4	6PCS/Blister	92 x 42 x 5	10Packs	245 x 120 x 130	100Packs	62 x 26 x 15	500Packs	7.8	0.0242
A312-BP6	4260033151995	48 x 90 x 3	6PCS/Blister	92 x 42 x 5	10Packs	195 x 120 x 130	100Packs	62 x 22 x 15	500Packs	4.2	0.0205

## Battery Adapter



### Warning:

When using two or more adapters together, avoid mixing new and used batteries, batteries with different charge levels or different types and brands. Don't mix adapters with actual D batteries in the device. Please insert the AA batteries into the adapter correctly. Remove battery after use, or when not in use. Store adapter separately from battery. Do not recharge battery while in the adapter.

## Battery Case



### MAIN FEATURES

- Durable plastic case holds up to 4 AA/AAA batteries.
- Keep your batteries together and safe.

### Directions

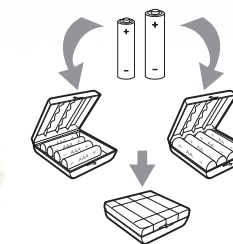

## Battery Tester



### BT-0503

Tests AA, AAA, Battery

### MAIN FEATURES

- Quickly determines if battery needs charging or replacing
- On the spot testing
- just insert and check LED
- Compact & light

- Insert battery: Observe polarity

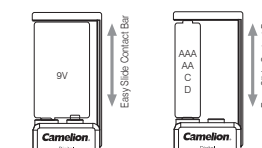

- Check LED indicator: If LED fluctuates press slightly

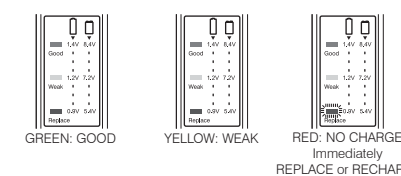

### BT-0503



Packaging	1 pcs/pack	Gross Weight:	8.7 kg
Blister	60 packs/box	Volume:	0.0388 cbm
Inner Box	240 packs/carton		
Outer Carton			
Dimensions			
Blister (mm)	65(W)x 154(H) x 16(D)		
Inner Box (cm)	44(L)x 11.5(W) x 16.5(H)		
Outer Carton (cm)	45(L)x 34.5(W) x 25(H)		



### BT-0506

Tests AA, AAA, C, D, 9V and some models of button cell

### MAIN FEATURES

- Easy to Read LCD Display for displaying real time battery conditions.
- Three-color Scale and Voltage Level for easily reading the battery voltage and power conditions.
- Wide Usage Available to test most 1.5V and 9V batteries.
- Retractable Test Arm easily adapts to different battery types.
- Compact and Portable

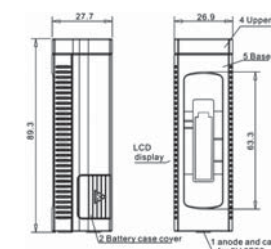

### BT-0506



Packaging	1 pcs/pack	Gross Weight:	6.5 kg
Blister	12 packs/box	Volume:	0.0459 cbm
Inner Box	96 packs/carton		
Outer Carton			
Dimensions			
Blister (mm)	65(W)x 154(H) x 28(D)		
Inner Box (cm)	37(L)x 16.5(W) x 8(H)		
Outer Carton (cm)	38(L)x 35(W) x 34.5(H)		



# Device Chart

✓ BEST   
 ✓ GOOD   
 NO

Classification	Camelion Series	Lithium Batteries			Carbon Zinc	Lithium Photo	Silver Oxide	Lithium Button Cell	Alkaline Button Cell	Zinc Air
		Lithium P7	Digi-Alkaline	Plus Alkaline	Super Heavy Duty	Lithium Photo	Micro Batteries	Micro Batteries	Micro Batteries	Hearing Aid
Music	MP3	✓	✓	✓						
	Walkman	✓	✓	✓	✓					
	iPod®									
	CD/DVD/MiniDisc	✓	✓							
	Headphones	✓	✓	✓	✓					
	Boombox	✓	✓							
	Karaoke							✓		
	AM/FM Radio	✓	✓	✓	✓		✓	✓	✓	
Cassette	✓	✓	✓	✓						
Toys & Games	Remote Control/Toys	✓	✓	✓	✓		✓		✓	
	Racing Car	✓	✓	✓	✓		✓			
	Playstation®	✓	✓	✓	✓		✓			
	Blinker								✓	
Photo & Video	Laser Point								✓	
	Digital Camera	✓	✓			✓		✓	✓	
	Liquid Crystal TVs	✓	✓	✓						
	Portable Reader									
	CCTV/Surveillance									
	Analog Camera	✓	✓	✓		✓	✓	✓		
	Camcorder							✓		
Mobile & Professional	Flashlight		✓	✓	✓	✓		✓		
	Cellular & Cordless Phone							✓		
	Bluetooth									
	Mobile Phone									
	PDA Phone									
	IP Phone									
	Blackberry®									
	Transceivers		✓	✓	✓					
Office Appliances	Pagers		✓	✓	✓					✓
	Notebook							✓		
	Hand Copy/Fax Machines		✓	✓				✓		
	Transcribers		✓	✓	✓					
	Walkie Talkie									
	Watches & Electronics						✓	✓	✓	
	Calculator		✓	✓	✓		✓	✓	✓	
	Car Alarm							✓		
Other	Wi-Fi							✓		
	PDA							✓		
	Clocks		✓	✓	✓			✓	✓	
	Infrared Inductor		✓	✓						
	Micrometers						✓			
	Interphones/telephones			✓	✓					
	Electronic lighters						✓	✓		
	Strobe lights		✓					✓		
	Autowinders		✓							
	Shavers		✓							
	IC/ID Cards							✓		
Hearing Aid									✓	
Smoke Alarm										
Measuring Devices		✓	✓	✓			✓	✓		

## Please Note:

These are recommended matchings only.  
 For the most accurate information please refer to your device manufacturer's specifications.  
 Camelion accepts no responsibility for any accidents resulting from use of this information.

## Specifications

	Lithium P7		Digi Alkaline		Plus Alkaline							Super Heavy Duty							
	FR6	FR03	LR6	LR03	LR20	LR14	LR6	LR03	LR61	6LF22**	3LR12	R6	R03	R20	R14	6F22**	3R12*	4R25**	R10
Nominal Voltage(V)	1.5	1.5	1.5	1.5	1.5	1.5	1.5	1.5	1.5	9	4.5	1.5	1.5	1.5	1.5	9	4.5	6	1.5
Average Capacity(mAh)	2900	1050	3220	1280	21000	8450	2800	1250	580	700**	5900*	1220	550	8050	3850	450	2000	11000	500

20+-2°C, Rated capacity at 25 mA continuous drain, to 0.8V  
 \* 20+-2°C, Rated capacity at 25 mA continuous drain, to 2.7V  
 \*\* 20+-2°C, Rated capacity at 25 mA continuous drain, to 4.8V



# AlwaysReady™

## Ni-MH Always Ready Rechargeable Batteries

The new Camelion AlwaysReady battery is ready to be used right from the package. It holds the charge for up to a year. And they can be recharged again and again, saving you money. Are you ready? Try AlwaysReady batteries today!



**MAX** ——— Maximum capacity, ideal for professional use



### NH-AA2500ARBP4

<b>1.2V AA</b>	4 260216 453045
Packaging	4 pcs/pack
Blister	12 packs/box
Inner Box	96 packs/carton
Outer Carton	240 packs/carton
Gross Weight:	12.0 kg
Volume:	0.0144 cbm
<b>Dimensions</b>	
Blister (mm)	90(W) x 117(H) x 15(D)
Inner Box (mm)	134(L) x 104(W) x 97(H)
Outer Carton (cm)	29.0(L) x 21.5(W) x 23.0(H)

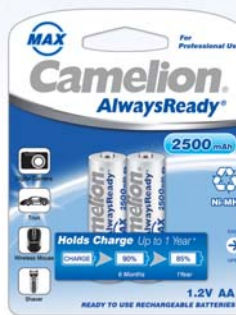

### NH-AA2500ARBP2

<b>1.2V AA</b>	4 260216 453038
Packaging	2 pcs/pack
Blister	12 packs/box
Inner Box	96 packs/carton
Outer Carton	192 packs/carton
Gross Weight:	13.1 kg
Volume:	0.0274 cbm
<b>Dimensions</b>	
Blister (mm)	90(W) x 117(H) x 15(D)
Inner Box (mm)	134(L) x 104(W) x 97(H)
Outer Carton (cm)	41.0(L) x 29.0(W) x 23.0(H)



**PREMIUM** ——— Suitable for all high drain devices



### NH-AA2300ARBP4

<b>1.2V AA</b>	4 260033 154040
Packaging	4 pcs/pack
Blister	12 packs/box
Inner Box	96 packs/carton
Outer Carton	240 packs/carton
Gross Weight:	11.8 kg
Volume:	0.0144 cbm
<b>Dimensions</b>	
Blister (mm)	90(W) x 117(H) x 15(D)
Inner Box (mm)	134(L) x 104(W) x 97(H)
Outer Carton (cm)	29.0(L) x 21.5(W) x 23.0(H)



### NH-AA2300ARBP2

<b>1.2V AA</b>	4 260033 152336
Packaging	2 pcs/pack
Blister	12 packs/box
Inner Box	96 packs/carton
Outer Carton	192 packs/carton
Gross Weight:	12.9 kg
Volume:	0.0274 cbm
<b>Dimensions</b>	
Blister (mm)	90(W) x 117(H) x 15(D)
Inner Box (mm)	134(L) x 104(W) x 97(H)
Outer Carton (cm)	41.0(L) x 29.0(W) x 23.0(H)



### NH-AA2100ARBP4

<b>1.2V AA</b>	4 260033 152282
Packaging	4 pcs/pack
Blister	12 packs/box
Inner Box	96 packs/carton
Outer Carton	240 packs/carton
Gross Weight:	11.7 kg
Volume:	0.0143 cbm
<b>Dimensions</b>	
Blister (mm)	90(W) x 117(H) x 15(D)
Inner Box (mm)	134(L) x 104(W) x 97(H)
Outer Carton (cm)	29.0(L) x 21.5(W) x 23.0(H)



### NH-AA2100ARBP2

<b>1.2V AA</b>	4 260033 152275
Packaging	2 pcs/pack
Blister	12 packs/box
Inner Box	96 packs/carton
Outer Carton	192 packs/carton
Gross Weight:	12.7 kg
Volume:	0.0273 cbm
<b>Dimensions</b>	
Blister (mm)	90(W) x 117(H) x 15(D)
Inner Box (mm)	134(L) x 104(W) x 97(H)
Outer Carton (cm)	41.0(L) x 29.0(W) x 23.0(H)



### NH-AAA800ARBP4

<b>1.2V AAA</b>	4 260033 152312
Packaging	4 pcs/pack
Blister	12 packs/box
Inner Box	144 packs/carton
Outer Carton	240 packs/carton
Gross Weight:	9.2 kg
Volume:	0.0168 cbm
<b>Dimensions</b>	
Blister (mm)	90(W) x 117(H) x 11(D)
Inner Box (mm)	125(L) x 84(W) x 97(H)
Outer Carton (cm)	31.0(L) x 27.0(W) x 20.0(H)

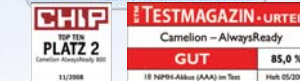

### NH-AAA800ARBP2

<b>1.2V AAA</b>	4 260033 152305
Packaging	2 pcs/pack
Blister	12 packs/box
Inner Box	240 packs/carton
Outer Carton	240 packs/carton
Gross Weight:	8.4 kg
Volume:	0.0269 cbm
<b>Dimensions</b>	
Blister (mm)	90(W) x 117(H) x 11(D)
Inner Box (mm)	125(L) x 84(W) x 97(H)
Outer Carton (cm)	51.0(L) x 27.0(W) x 19.5(H)

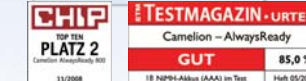

### NH-9V200ARBP1

<b>9V</b>	4 260033 155221
Packaging	1 pcs/pack
Blister	12 packs/box
Inner Box	240 packs/carton
Outer Carton	240 packs/carton
Gross Weight:	12.0 kg
Volume:	0.0385 cbm
<b>Dimensions</b>	
Blister (mm)	90(W) x 117(H) x 18(D)
Inner Box (mm)	135(L) x 125(W) x 97(H)
Outer Carton (cm)	51.0(L) x 29.0(W) x 26.0(H)

**Long Life** ——— Maximum rechargeable life cycle up to 1500 cycles



### NH-AA800ARBP2

<b>1.2V AA</b>	4 260216 453236
Packaging	2 pcs/pack
Blister	12 packs/box
Inner Box	96 packs/carton
Outer Carton	192 packs/carton
Gross Weight:	12.4 kg
Volume:	0.0274 cbm
<b>Dimensions</b>	
Blister (mm)	90(W) x 117(H) x 15(D)
Inner Box (mm)	134(L) x 104(W) x 97(H)
Outer Carton (cm)	41.0(L) x 29.0(W) x 23.0(H)



### NH-AAA600ARBP2

<b>1.2V AAA</b>	4 260216 453250
Packaging	2 pcs/pack
Blister	12 packs/box
Inner Box	240 packs/carton
Outer Carton	240 packs/carton
Gross Weight:	7.9 kg
Volume:	0.0269 cbm
<b>Dimensions</b>	
Blister (mm)	90(W) x 117(H) x 11(D)
Inner Box (mm)	125(L) x 84(W) x 97(H)
Outer Carton (cm)	51.0(L) x 27.0(W) x 19.5(H)



# Ni-MH Rechargeable Batteries

Camelion Ni-MH Rechargeable batteries offer high capacity performance, up to 1000 recharge cycles, and because they are used again and again they help reduce environmental waste. High drain devices such as music players and digital cameras are supported, therefore, you can hear more songs and take more photos.



**NH-D7000BP2**  
**1.2V D**  
 Packaging 4 260033 151520  
 Blister 2 pcs/pack Gross Weight: 19.0 kg  
 Inner Box 6 packs/box Volume: 0.0234 cbm  
 Outer Carton 60 packs/carton  
 Dimensions  
 Blister (mm) 90(W) x 117(H) x 34(D)  
 Inner Box (mm) 160(L) x 112(W) x 97(H)  
 Outer Carton (cm) 34.0(L) x 27.5(W) x 25.0(H)



**NH-D10000BP2**  
**1.2V D**  
 Packaging 4 260033 151865  
 Blister 2 pcs/pack Gross Weight: 17.0 kg  
 Inner Box 6 packs/box Volume: 0.0244 cbm  
 Outer Carton 48 packs/carton  
 Dimensions  
 Blister (mm) 90(W) x 117(H) x 34(D)  
 Inner Box (mm) 165(L) x 135(W) x 105(H)  
 Outer Carton (cm) 43.5(L) x 35.0(W) x 16.0(H)



**NH-D2500BP2**  
**1.2V D**  
 Packaging 4 260033 151537  
 Blister 2 pcs/pack Gross Weight: 11.2 kg  
 Inner Box 6 packs/box Volume: 0.0234 cbm  
 Outer Carton 60 packs/carton  
 Dimensions  
 Blister (mm) 90(W) x 117(H) x 34(D)  
 Inner Box (mm) 160(L) x 112(W) x 97(H)  
 Outer Carton (cm) 34.0(L) x 27.5(W) x 25.0(H)



**NH-C3500BP2**  
**1.2V C**  
 Packaging 4 260033 151544  
 Blister 2 pcs/pack Gross Weight: 16.8 kg  
 Inner Box 6 packs/box Volume: 0.0248 cbm  
 Outer Carton 96 packs/carton  
 Dimensions  
 Blister (mm) 90(W) x 117(H) x 27(D)  
 Inner Box (mm) 138(L) x 90(W) x 97(H)  
 Outer Carton (cm) 41.0(L) x 29.5(W) x 20.5(H)



**NH-C2500BP2**  
**1.2V C**  
 Packaging 4 260033 151551  
 Blister 2 pcs/pack Gross Weight: 16.0 kg  
 Inner Box 6 packs/box Volume: 0.0248 cbm  
 Outer Carton 96 packs/carton  
 Dimensions  
 Blister (mm) 90(W) x 117(H) x 27(D)  
 Inner Box (mm) 138(L) x 90(W) x 97(H)  
 Outer Carton (cm) 41.0(L) x 29.5(W) x 20.5(H)

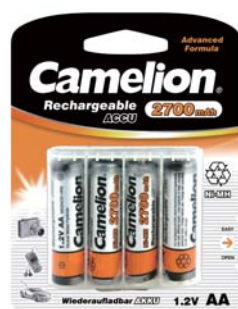

**NH-AA2700BC4**  
**1.2V AA**  
 Packaging 4 260033 151933  
 Blister 4 pcs/pack Gross Weight: 13.4 kg  
 Inner Box 12 packs/box Volume: 0.0144 cbm  
 Outer Carton 96 packs/carton  
 Dimensions  
 Blister (mm) 90(W) x 117(H) x 15(D)  
 Inner Box (mm) 134(L) x 104(W) x 97(H)  
 Outer Carton (cm) 29.0(L) x 21.5(W) x 23.0(H)

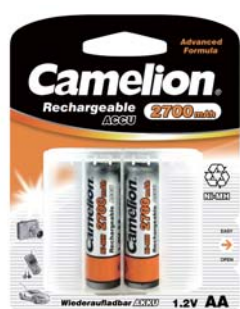

**NH-AA2700BC2**  
**1.2V AA**  
 Packaging 4 260033 151926  
 Blister 2 pcs/pack Gross Weight: 14.0 kg  
 Inner Box 12 packs/box Volume: 0.0274 cbm  
 Outer Carton 192 packs/carton  
 Dimensions  
 Blister (mm) 90(W) x 117(H) x 15(D)  
 Inner Box (mm) 134(L) x 104(W) x 97(H)  
 Outer Carton (cm) 41.0(L) x 29.0(W) x 23.0(H)



**NH-AA2600BC4**  
**1.2V AA**  
 Packaging 4 260033 151902  
 Blister 4 pcs/pack Gross Weight: 13.2 kg  
 Inner Box 12 packs/box Volume: 0.0144 cbm  
 Outer Carton 96 packs/carton  
 Dimensions  
 Blister (mm) 90(W) x 117(H) x 15(D)  
 Inner Box (mm) 134(L) x 104(W) x 97(H)  
 Outer Carton (cm) 29.0(L) x 21.5(W) x 23.0(H)



**NH-AA2500BC4**  
**1.2V AA**  
 Packaging 4 260033 151834  
 Blister 4 pcs/pack Gross Weight: 13.0 kg  
 Inner Box 12 packs/box Volume: 0.0144 cbm  
 Outer Carton 96 packs/carton  
 Dimensions  
 Blister (mm) 90(W) x 117(H) x 15(D)  
 Inner Box (mm) 134(L) x 104(W) x 97(H)  
 Outer Carton (cm) 29.0(L) x 21.5(W) x 23.0(H)



**NH-AA2600BC2**  
**1.2V AA**  
 Packaging 4 260033 151896  
 Blister 2 pcs/pack Gross Weight: 14.5 kg  
 Inner Box 12 packs/box Volume: 0.0274 cbm  
 Outer Carton 192 packs/carton  
 Dimensions  
 Blister (mm) 90(W) x 117(H) x 15(D)  
 Inner Box (mm) 134(L) x 104(W) x 97(H)  
 Outer Carton (cm) 41.0(L) x 29.0(W) x 23.0(H)



**NH-AA2500BC2**  
**1.2V AA**  
 Packaging 4 260033 151827  
 Blister 2 pcs/pack Gross Weight: 14.3 kg  
 Inner Box 12 packs/box Volume: 0.0274 cbm  
 Outer Carton 192 packs/carton  
 Dimensions  
 Blister (mm) 90(W) x 117(H) x 15(D)  
 Inner Box (mm) 134(L) x 104(W) x 97(H)  
 Outer Carton (cm) 41.0(L) x 29.0(W) x 23.0(H)



**NH-AA2300BP4**  
**1.2V AA**  
 Packaging 4 260033 151742  
 Blister 4 pcs/pack Gross Weight: 12.6 kg  
 Inner Box 12 packs/box Volume: 0.0144 cbm  
 Outer Carton 96 packs/carton  
 Dimensions  
 Blister (mm) 90(W) x 117(H) x 15(D)  
 Inner Box (mm) 134(L) x 104(W) x 97(H)  
 Outer Carton (cm) 29.0(L) x 21.5(W) x 23.0(H)



**NH-AA2300BP2**  
**1.2V AA**  
 Packaging 4 260033 151735  
 Blister 2 pcs/pack Gross Weight: 13.9 kg  
 Inner Box 12 packs/box Volume: 0.0274 cbm  
 Outer Carton 192 packs/carton  
 Dimensions  
 Blister (mm) 90(W) x 117(H) x 15(D)  
 Inner Box (mm) 134(L) x 104(W) x 97(H)  
 Outer Carton (cm) 41.0(L) x 29.0(W) x 23.0(H)



**NH-AA2000BP2**  
**1.2V AA**  
 Packaging 4 260033 151582  
 Blister 2 pcs/pack Gross Weight: 11.8 kg  
 Inner Box 12 packs/box Volume: 0.0274 cbm  
 Outer Carton 192 packs/carton  
 Dimensions  
 Blister (mm) 90(W) x 117(H) x 15(D)  
 Inner Box (mm) 134(L) x 104(W) x 97(H)  
 Outer Carton (cm) 41.0(L) x 29.0(W) x 23.0(H)



**NH-AA1800BP4**  
**1.2V AA**  
 Packaging 4 260033 151612  
 Blister 4 pcs/pack Gross Weight: 11.8 kg  
 Inner Box 12 packs/box Volume: 0.0144 cbm  
 Outer Carton 96 packs/carton  
 Dimensions  
 Blister (mm) 90(W) x 117(H) x 15(D)  
 Inner Box (mm) 134(L) x 104(W) x 97(H)  
 Outer Carton (cm) 29.0(L) x 21.5(W) x 23.0(H)





NH-AA1800BP2

**1.2V AA**

Packaging 4 260033 151605  
 Blister 2 pcs/pack Gross Weight: 12.7 kg  
 Inner Box 12 packs/box Volume: 0.0274 cbm  
 Outer Carton 192 packs/carton

Dimensions  
 Blister (mm) 90(W) x 117(H) x 15(D)  
 Inner Box (mm) 134(L) x 104(W) x 97(H)  
 Outer Carton (cm) 41.0(L) x 29.0(W) x 23.0(H)



NH-AA1500BP2

**1.2V AA**

Packaging 4 260033 151629  
 Blister 2 pcs/pack Gross Weight: 11.2 kg  
 Inner Box 12 packs/box Volume: 0.0274 cbm  
 Outer Carton 192 packs/carton

Dimensions  
 Blister (mm) 90(W) x 117(H) x 15(D)  
 Inner Box (mm) 134(L) x 104(W) x 97(H)  
 Outer Carton (cm) 41.0(L) x 29.0(W) x 23.0(H)



NH-AAA800BP4

**1.2V AAA**

Packaging 4 260033 151674  
 Blister 4 pcs/pack Gross Weight: 7.8 kg  
 Inner Box 12 packs/box Volume: 0.0168 cbm  
 Outer Carton 144 packs/carton

Dimensions  
 Blister (mm) 90(W) x 117(H) x 11(D)  
 Inner Box (mm) 125(L) x 84(W) x 97(H)  
 Outer Carton (cm) 31.0(L) x 27.0(W) x 20.0(H)



NH-AAA800BP2

**1.2V AAA**

Packaging 4 260033 151667  
 Blister 2 pcs/pack Gross Weight: 7.7 kg  
 Inner Box 12 packs/box Volume: 0.0269 cbm  
 Outer Carton 240 packs/carton

Dimensions  
 Blister (mm) 90(W) x 117(H) x 11(D)  
 Inner Box (mm) 125(L) x 84(W) x 97(H)  
 Outer Carton (cm) 51.0(L) x 27.0(W) x 19.5(H)



NH-AAA1100BP4

**1.2V AAA**

Packaging 4 260033 151957  
 Blister 4 pcs/pack Gross Weight: 9.8 kg  
 Inner Box 12 packs/box Volume: 0.0168 cbm  
 Outer Carton 144 packs/carton

Dimensions  
 Blister (mm) 90(W) x 117(H) x 11(D)  
 Inner Box (mm) 125(L) x 84(W) x 97(H)  
 Outer Carton (cm) 31.0(L) x 27.0(W) x 20.0(H)



NH-AAA1100BP2

**1.2V AAA**

Packaging 4 260033 151940  
 Blister 2 pcs/pack Gross Weight: 9.7 kg  
 Inner Box 12 packs/box Volume: 0.0269 cbm  
 Outer Carton 240 packs/carton

Dimensions  
 Blister (mm) 90(W) x 117(H) x 11(D)  
 Inner Box (mm) 125(L) x 84(W) x 97(H)  
 Outer Carton (cm) 51.0(L) x 27.0(W) x 19.5(H)



NH-AAA600BP4

**1.2V AAA**

Packaging 4 260033 151711  
 Blister 4 pcs/pack Gross Weight: 7.8 kg  
 Inner Box 12 packs/box Volume: 0.0168 cbm  
 Outer Carton 144 packs/carton

Dimensions  
 Blister (mm) 90(W) x 117(H) x 11(D)  
 Inner Box (mm) 125(L) x 84(W) x 97(H)  
 Outer Carton (cm) 31.0(L) x 27.0(W) x 20.0(H)



NH-AAA600BP2

**1.2V AAA**

Packaging 4 260033 151704  
 Blister 2 pcs/pack Gross Weight: 7.7 kg  
 Inner Box 12 packs/box Volume: 0.0269 cbm  
 Outer Carton 240 packs/carton

Dimensions  
 Blister (mm) 90(W) x 117(H) x 11(D)  
 Inner Box (mm) 125(L) x 84(W) x 97(H)  
 Outer Carton (cm) 51.0(L) x 27.0(W) x 19.5(H)



NH-AAA1000BP4

**1.2V AAA**

Packaging 4 260033 151889  
 Blister 4 pcs/pack Gross Weight: 8.7 kg  
 Inner Box 12 packs/box Volume: 0.0168 cbm  
 Outer Carton 144 packs/carton

Dimensions  
 Blister (mm) 90(W) x 117(H) x 11(D)  
 Inner Box (mm) 125(L) x 84(W) x 97(H)  
 Outer Carton (cm) 31.0(L) x 27.0(W) x 20.0(H)



NH-AAA1000BP2

**1.2V AAA**

Packaging 4 260033 151872  
 Blister 2 pcs/pack Gross Weight: 8.7 kg  
 Inner Box 12 packs/box Volume: 0.0269 cbm  
 Outer Carton 240 packs/carton

Dimensions  
 Blister (mm) 90(W) x 117(H) x 11(D)  
 Inner Box (mm) 125(L) x 84(W) x 97(H)  
 Outer Carton (cm) 51.0(L) x 27.0(W) x 19.5(H)



NH-9V250BP1

**9V Voltage: 8.4V**

Packaging 4 260033 151810  
 Blister 1 pcs/pack Gross Weight: 12.3 kg  
 Inner Box 12 packs/box Volume: 0.0385 cbm  
 Outer Carton 240 packs/carton

Dimensions  
 Blister (mm) 90(W) x 117(H) x 18(D)  
 Inner Box (mm) 135(L) x 125(W) x 97(H)  
 Outer Carton (cm) 51.0(L) x 29.0(W) x 26.0(H)



NH-9V200BP1

**9V Voltage: 8.4V**

Packaging 4 260033 151728  
 Blister 1 pcs/pack Gross Weight: 11.6 kg  
 Inner Box 12 packs/box Volume: 0.0385 cbm  
 Outer Carton 240 packs/carton

Dimensions  
 Blister (mm) 90(W) x 117(H) x 18(D)  
 Inner Box (mm) 135(L) x 125(W) x 97(H)  
 Outer Carton (cm) 51.0(L) x 29.0(W) x 26.0(H)



NH-AAA900BP4

**1.2V AAA**

Packaging 4 260033 151766  
 Blister 4 pcs/pack Gross Weight: 8.7 kg  
 Inner Box 12 packs/box Volume: 0.0168 cbm  
 Outer Carton 144 packs/carton

Dimensions  
 Blister (mm) 90(W) x 117(H) x 11(D)  
 Inner Box (mm) 125(L) x 84(W) x 97(H)  
 Outer Carton (cm) 31.0(L) x 27.0(W) x 20.0(H)



NH-AAA900BP2

**1.2V AAA**

Packaging 4 260033 151759  
 Blister 2 pcs/pack Gross Weight: 8.7 kg  
 Inner Box 12 packs/box Volume: 0.0269 cbm  
 Outer Carton 240 packs/carton

Dimensions  
 Blister (mm) 90(W) x 117(H) x 11(D)  
 Inner Box (mm) 125(L) x 84(W) x 97(H)  
 Outer Carton (cm) 51.0(L) x 27.0(W) x 19.5(H)



## > Green Energy Charger

These chargers are designed to help reduce damage to the environment. We own include our new solar charger with USB or solar charging. This unit offers economical charging by using the sun's energy, therefore, reducing electricity consumption.

# SBC3001

Charges:

2 or 4 x AA  
2 x AAA

Ni-MH



Solar Charger



USB Charger



Battery Tester



Power Supply

## Solar Charger



Uses sunlight to charge batteries!

Includes USB Power:



USB



## SPECIFICATIONS

### Charging Currents

200 mA (2 Pcs)  
100 mA (4 Pcs)

### USB output

5.0V  $\pm$  350 mA

## MAIN FEATURES

- **3 Independent Charging Channels** Charges up to 2 pairs of AA batteries or 1 pair of AAA batteries.
- **Reverse Polarity Protection** Prevents damage to the charger if the battery is improperly inserted.
- **Clean Energy** No need to use electricity, just use the sun's rays for power.
- **Saves Money** Reduces electricity consumption and purchases of single cell batteries.
- **USB Ports** Use to charge batteries or power your portable electronic devices.

- **Compact Lightweight Design** Convenient for travel or emergency use.
- **Battery Tester** Tests rechargeable or primary AA/AAA batteries.

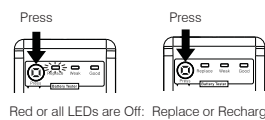
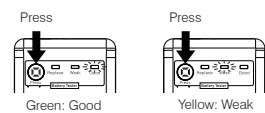

Red or all LEDs are Off: Replace or Recharge

## CHARGING TIMES

Type of Battery	Charging Times (Appr.)	
	2 Cells	4 Cells
Ni-MH AA 2000 mAh	14 h	27 h
Ni-MH AA 1500 mAh	10 h	21 h
Ni-MH AAA 800 mAh	5 h	10.6

## AVAILABLE COLORS

Black

## BARCODE



## PACKAGING



Blister	
Weight(g)	218.9
Dimensions (W) x (H) x (D) (mm)	168 x 250 x 83
Inner Carton	
Packs / Inner ctn	8
Net Weight(kg)	1.75
Gross Weight(kg)	2.15
Dimensions (L)x (W) x (H) (cm)	40 x 26 x 18
Outer Carton	
Packs / Carton	16
Net Weight(kg)	3.5
Gross Weight(kg)	4.7
Dimensions (L)x (W) x (H) (cm)	41.5 x 27.5 x 38.5
Volume(cbm)	0.0440

## > Ultra Fast Chargers

Offer the ultimate in speed charging. In as little as one hour one can use the same batteries again, saving time and money.

# BC-0907

Charges:

1-4 x AA  
1-4 x AAA

Ni-MH



AC Adapter



Car Adapter



## SPECIFICATIONS

### AC To DC Adapter

Input: 100-240V ~ 50/60Hz  
Output : 12V  $\pm$

### Car Plug

Output : 12V  $\pm$

### Charger

Charging Currents  
4x(1.4V  $\pm$  2200 mA) AA Size  
4x(1.4V  $\pm$  800 mA) AAA Size

## MAIN FEATURES

- **4 Independent Charging Channels**
- **6 Level Charge Protection**
  - $\Delta$ V Cut-Off
  - Timer Control Protection (1.5 hours)
  - Over Temperature Protection
  - Reverse Polarity Protection
  - Over Current and Short Circuit Protection
  - Defective and Non-rechargeable Battery Detection
- **Low Current Leakage** Minimizes loss of capacity and maintains battery charge by controlling current leakage.
- **Trickle Charge** maintains battery charge.
- **World Voltage Switch Adapter**

- **Battery Refresh** reduces memory effect and enables full discharge for long battery life.
- **Car Plug Adapter**
- **Pulse Charging Technology** for fast, efficient charging.
- **Easy To Read LCD Display** shows Charging Progress, Defective Battery, Battery Refresh Features.



## AVAILABLE COLORS

Silver

## BARCODE



## PACKAGING



Blister	
Plug:	TUV
Weight(g)	336
Dimensions (W) x (H) x (D) (mm)	125 x 205 x 67
Inner Carton	
Packs / Inner ctn	8
Net Weight(kg)	2.7
Gross Weight(kg)	3.25
Dimensions (L)x (W) x (H) (cm)	53 x 27 x 19
Outer Carton	
Packs / Carton	16
Net Weight(kg)	5.4
Gross Weight(kg)	7
Dimensions (L)x (W) x (H) (cm)	54.5 x 28.5 x 40.5
Volume(M <sup>3</sup> )	0.0629



> Super Fast Chargers

It charges most batteries in 1 to 4 hours. They also offer multiple levels of safety protection and many convenient features, such as LED displays and worldwide use plugs.

> Super Fast Chargers

**BC-1007**

Charges:

1-4 x AA

1-4 x AAA

Ni-MH



AC Adapter



**BC-0903**

Charges:

2 or 4 x AA

2 or 4 x AAA

Ni-MH



AC Adapter



USB



Car Adapter



**SPECIFICATIONS**

Input: 100-240V ~ 50/60Hz  
 Output: AA 1000 mA (1-2 pcs); 500 mA (3-4 pcs)  
 AAA 600 mA (1-2 pcs); 300 mA (3-4 pcs)

**MAIN FEATURES**

- Charges 1-4 AA/AAA Ni-MH /Ni-Cd Batteries
- 6 Levels Charge Protection
  - ΔV Cut Off
  - Over Temperature Protection
  - Timer Control Protection 3.5 hours (1-2 cells) or 7 hours (3-4 cells)
  - Reverse Polarity Protection
  - Over-current and Short Circuit Protection
  - Defective and Non-rechargeable Battery Detection
- Low Battery Current Leakage
- Worldwide Use AC 100-240V~50/60Hz
- LED Indicators

Red	Charging
Red LED Flashing	Defective / Non-rechargeable Battery/ Short circuit
Green	Fully charged/Trickle

**CHARGING TIMES**

Type of Battery	Charging Times (Appr.)	
	1-2 Cells	3-4 Cells
Ni-MH AA 2700 mAh	3 h	6 h
Ni-MH AA 2000 mAh	2.5 h	4.5 h
Ni-MH AA 1500 mAh	2 h	3.5 h
Ni-MH AAA 800 mAh	100 min	3 h

**AVAILABLE COLORS**

White

**BARCODE**



**PACKAGING**



Blister	
Plug:	TUV
Weight(g)	206.5
Dimensions (W) x (H) x (D) (mm)	125 x 205 x 87
Inner Carton	
Packs / Inner ctn	16
Net Weight(kg)	2.3
Gross Weight(kg)	3.8
Dimensions (L)x (W) x (H) (cm)	46 x 25.5 x 27
Outer Carton	
Packs / Carton	32
Net Weight(kg)	6.45
Gross Weight(kg)	8
Dimensions (L)x (W) x (H) (cm)	53 x 47.5 x 29
Volume(M³)	0.0730

**SPECIFICATIONS**

AC To DC Adapter

Input: 100-240V ~ 50/60Hz  
 Output : 12V ---

Car plug

Output : 12V ---

USB

Output : 5V ---

Charging Currents

12V DC Input  
 2 x (2.8V --- 900 mA) AA Size  
 2 x (2.8V --- 500 mA) AAA Size  
 5V DC Input  
 2 x (2.8V --- 500 mA) AA Size  
 2 x (2.8V --- 300 mA) AAA Size

**MAIN FEATURES**

- 2 Independent Charging Channels
- 6 Levels Charge Protection
  - ΔV Cut-Off
  - Timer Control Protection
  - Over Temperature Protection
  - Reverse Polarity Protection
  - Over Current and Short Circuit Protection
  - Defective and Non-rechargeable Battery Detection
- Low Battery Leakage Current
- Trickle Charge
- Car Plug Adapter and USB Port
- LED Indicators

Red	Charging
Flashing	Defective / Non-rechargeable battery/ Short circuit
Green	Fully charged/trickle

**CHARGING TIMES**

Type of Battery	Charging Times (Appr.)	
	Input 12V	Input 5V
Ni-MH AA 2700 mAh	3.0 h	6.0 h
Ni-MH AA 2000 mAh	2.7 h	4.8 h
Ni-MH AA 1500 mAh	2.0 h	3.6 h
Ni-MH AAA 800 mAh	1.9 h	3.2 h

**AVAILABLE COLORS**

Silver

**BARCODE**



**PACKAGING**



Blister	
Plug:	TUV
Weight(g)	230
Dimensions (W) x (H) x (D) (mm)	125 x 205 x 67
Inner Carton	
Packs / Inner ctn	8
Net Weight(kg)	1.85
Gross Weight(kg)	2.4
Dimensions (L)x (W) x (H) (cm)	49 x 22.5 x 19
Outer Carton	
Packs / Carton	16
Net Weight(kg)	3.7
Gross Weight(kg)	5.3
Dimensions (L)x (W) x (H) (cm)	51 x 47 x 20.5
Volume(M³)	0.0491



> Fast Chargers

Charge most batteries in 4 to 8 hours. Packed with features, they are handy around the home, at the office and even when traveling.

**BC-1002A**

Charges:

2 or 4 x AA

Ni-MH

2 or 4 x AAA



AC Adapter



**SPECIFICATIONS**

Input: 100-240V ~ 50/60Hz  
Output: 2 x (2.8V  $\pm$  300mA) AA Size  
2 x (2.8V  $\pm$  150mA) AAA Size

**MAIN FEATURES**

- 2 Independent Charging Channels
- Timer Control (8 hours)
- Over Temperature Protection
- Worldwide Use

- Reverse Polarity Protection
- LED Indicators

ON	Charging
OFF	Fully charged

**CHARGING TIMES**

Type of Battery	Charging Times (Appr.)
Ni-MH AA 2500 mAh	8 h
Ni-MH AA 2000 mAh	8 h
Ni-MH AA 1500 mAh	6 h
Ni-MH AAA 800 mAh	8 h

**AVAILABLE COLORS**

silver

**BARCODE**



**PACKAGING**



Blister	
Plug:	TUV
Weight(g)	118
Dimensions (W) x (H) x (D) (mm)	125 x 205 x 85
Inner Carton	
Packs / Inner ctn	16
Net Weight(kg)	1.89
Gross Weight(kg)	3.42
Dimensions (L)x (W) x (H) (cm)	46 x 24.5 x 27
Outer Carton	
Packs / Carton	32
Net Weight(kg)	3.8
Gross Weight(kg)	7.53
Dimensions (L)x (W) x (H) (cm)	51 x 47.5 x 29
Volume(M <sup>3</sup> )	0.0703

> Fast Chargers

**BC-1012**

Charges:

1-4 x AA

Ni-MH

1-4 x AAA



**SPECIFICATIONS**

Input: 100-240V ~ 50/60Hz  
Output: 1.4V  $\pm$   
AA : 400 mA (1~2 Pcs ); 260 mA (3 Pcs ); 200 mA (4 Pcs )  
AAA : 200 mA (1~2 Pcs ); 130 mA (3 Pcs ); 100 mA (4 Pcs )

**MAIN FEATURES**

- **Charges up to 4 AA/AAA Ni-MH/Ni-Cd Batteries**
- **Multi-band LCD Monitor** for easy to read status of the charger
- **4 Independent Charging Channels** Four charging slots support any AA/AAA battery combination.
- **Reverse Polarity Protection** A special shell structure prevents incorrect battery insertion, helping avoid damage to the battery and charger.
- **Pulse Charging Technology** Uses a precisely regulated current to maximize the charging efficiency, control battery temperature and increase battery life.
- **Micro Control Unit (MCU)** The MCU enables intelligent charging by automatically identifying non-rechargeable batteries, offering multiple levels of protection including negative delta V(- $\Delta$ V), voltage protection, safety charging cut-offs.
- **Over Current Protection** Charger maintains a constant charging current during the charging cycle.
- **Short Circuit Protection** The MCU detects attempts to charge shorted batteries or directly short the output channels, in which case the LCD indicator flashes.
- **Timer Control** The charger automatically detects the correct charging time, cuts off the charger automatically(1-2 batteries 6 hours), (3 batteries 9 hours), (4 batteries 12 hours).

**AVAILABLE COLORS**

white

**MAIN FEATURES**

Type of Battery	Charging Times (Appr.)		
	1-2 Akku	3 Akkus	4 Akkus
Ni-MH AA 2500 mAh	6 h	9 h	12 h
Ni-MH AA 2000 mAh	6 h	9 h	12 h
Ni-MH AAA 1000 mAh	6 h	9 h	12 h
Ni-MH AAA 800 mAh	5 h	8.5 h	11 h

**BARCODE**



**PACKAGING**



Blister	
Plug:	TUV
Weight(g)	118.2
Dimensions (W) x (H) x (D) (mm)	125 x 205x 75
Inner Carton	
Packs / Inner ctn	8
Net Weight(kg)	0.95
Gross Weight(kg)	1.3
Dimensions (L)x (W) x (H) (cm)	49.5 x 23.5 x 14
Outer Carton	
Packs / Carton	32
Net Weight(kg)	3.78
Gross Weight(kg)	5.5
Dimensions (L)x (W) x (H) (cm)	50.5 x 48.5 x 30
Volume(M <sup>3</sup> )	0.0735



> Overnight Chargers

These Standard battery chargers are ideal for travel, conventional household or office use. Some are also powered by USB ports.

**BC-1001A**

Charges:

1-2 x AA

1-2 x AAA

1 x 9V

Ni-MH



**SPECIFICATIONS**

Input: 100-240V ~ 50/60Hz  
Output: 2 x (1.4V = 200 mA) AA/AAA Size  
1 x (9V = 25 mA) 9V Size

**MAIN FEATURES**

- 3 Independent Charging Channels
- 12 Hours Timer Control
- Reverse Polarity Protection
- Slim and Portable
- Built-in Switching Adaptor for Worldwide Use
- LED Indicators

Red	Charging
Off	Fully charged

**CHARGING TIMES**

Type of Battery	Charging Times (Appr.)
Ni-MH AA 2700 mAh	12 h
Ni-MH AA 2000 mAh	12 h
Ni-MH AA 1500 mAh	10.5 h
Ni-MH AAA 800 mAh	5 h
Ni-MH 9V 200 mAh	9.5 h

**AVAILABLE COLORS**

Titanium

**BARCODE**



**PACKAGING**



Blister	
Plug:	TUV
Weight(g)	62
Dimensions (W) x (H) x (D) (mm)	87 x 172 x 50
Inner Carton	
Packs / Inner ctn	32
Net Weight(kg)	1.98
Gross Weight(kg)	2.42
Dimensions (L)x (W) x (H) (cm)	39.5 x 37.5 x 18
Outer Carton	
Packs / Carton	64
Net Weight(kg)	4.0
Gross Weight(kg)	7.5
Dimensions (L)x (W) x (H) (cm)	41 x 39 x 39
Volume(M³)	0.0624

> Overnight Chargers

**BC-1021C**

Charges:

1-2 x AA

1-2 x AAA

Ni-MH



**SPECIFICATIONS**

Input: 100-240V ~ 50/60Hz 5W  
Output: 2 x (1.4V = 200 mA) AA Size  
2 x (1.4V = 100 mA) AAA Size

**MAIN FEATURES**

- Charges 1 or 2 Ni-MH/Ni-Cd AA/AAA batteries
- Reverse Polarity Protection Specially designed slots prevent incorrect polarity insertion of the batteries.
- Timer Control Protection (12 Hrs) The charger automatically detects the correct charging time and after 12 hrs the main charging current switches to a trickle current.
- Low Charge Current for Longer Battery Life
- Low Battery Leakage Current If the battery charger is not connected to input power and batteries are left in the charger, battery discharge will be controlled using the lowest possible, pre-determined current.
- 2 LED Indicators

Red	Charging
Green	Fully charged/Trickle

**CHARGING TIMES**

Type of Battery	Charging Times (Appr.)
Ni-MH AA 2000 mAh	12.0 h
Ni-MH AA 1500 mAh	10.5 h
Ni-MH AAA 800 mAh	11 h

**AVAILABLE COLORS**

white

**BARCODE**



**PACKAGING**



Blister	
Plug:	TUV
Weight(g)	105
Dimensions (W) x (H) x (D) (mm)	100 x 180 x 46
Inner Carton	
Packs / Inner ctn	32
Net Weight(kg)	3.36
Gross Weight(kg)	3.7
Dimensions (L)x (W) x (H) (cm)	41.8 x 27 x 22.5
Outer Carton	
Packs / Carton	64
Net Weight(kg)	6.7
Gross Weight(kg)	8.3
Dimensions (L)x (W) x (H) (cm)	43 x 28.2 x 49.8
Volume(M³)	0.0604



## BC-0901

Charges:

1-2 ×  **Ni-MH**

1-2 × 



### SPECIFICATIONS

Input: 120V ~ 60Hz or 230V ~ 50Hz  
Output: 2 x (1.4V = 100mA) AA/AAA size

### MAIN FEATURES

- 2 Independent Channels
- Reverse Polarity Protection

- LED Indicators

 Charging or charge complete

### CHARGING TIMES

Type of Battery	Charging Times (Appr.)
Ni-MH AA 2000 mAh	27h
Ni-MH AA 1800 mAh	25 h
Ni-MH AA 1500 mAh	21h
Ni-MH AAA 600 mAh	11 h

### AVAILABLE COLORS

 Silver  white

### BARCODE



### PACKAGING



Blister	
Plug:	TUV
Weight(g)	155
Dimensions (W) x (H) x (D) (mm)	125 x 205 x 80
Inner Carton	
Packs / Inner ctn	16
Net Weight(kg)	2.48
Gross Weight(kg)	2.73
Dimensions (L)x (W) x (H) (cm)	39.5 x 23.5 x 12.5
Outer Carton	
Packs / Carton	32
Net Weight(kg)	4.96
Gross Weight(kg)	7.2
Dimensions (L)x (W) x (H) (cm)	48.5 x 41 x 27
Volume(M³)	0.0537

## BC-0902

Charges:

2 or 4 ×  **Ni-MH**

2 or 4 × 



### SPECIFICATIONS

Input: 120V ~ 60Hz or 230V ~ 50Hz  
Output: 2 x (2,8V = 200mA) AA  
2 x (2,8V = 120mA) AAA

### MAIN FEATURES

- 2 Independent Channels
- Reverse Polarity Protection

- LED Indicators

 Charging or charge complete

### CHARGING TIMES

Type of Battery	Charging Times (Appr.)
Ni-MH AA 2700 mAh	17 h
Ni-MH AA 2000 mAh	14 h
Ni-MH AA 1500 mAh	10.5 h
Ni-MH AAA 600 mAh	7 h

### AVAILABLE COLORS

 Silver

### BARCODE



### PACKAGING



Blister	
Plug:	TUV
Weight(g)	274
Dimensions (W) x (H) x (D) (mm)	210 x 130 x 82
Inner Carton	
Packs / Inner ctn	8
Net Weight(kg)	1.1
Gross Weight(kg)	1.3
Dimensions (L)x (W) x (H) (cm)	50.0 x 26 x 14.5
Outer Carton	
Packs / Carton	16
Net Weight(kg)	4.4
Gross Weight(kg)	7.5
Dimensions (L)x (W) x (H) (cm)	51.5 x 27.5 x 31.5
Volume(M³)	0.0446



## BC-0904S

Charges:

2 or 4 x AA

2 or 4 x AAA

1-2 x 9V

Ni-MH



### SPECIFICATIONS

Input: 120V ~ 60Hz or 230V ~ 50Hz  
 Output: 2 x (2.8V  $\approx$  160 mA) AA size  
 2 x (2.8V  $\approx$  80 mA) AAA size  
 2 x (9V  $\approx$  25 mA) 9V size

### MAIN FEATURES

- 2 independent Charging Channels
- Reverse Polarity Protection
- Low Charge Current for Longer Battery Life
- LED Indicators

Red	Charging or charge complete
-----	-----------------------------

### CHARGING TIMES

Type of Battery	Charging Times (Appr.)
Ni-MH AA 2000 mAh	17 h
Ni-MH AA 1500 mAh	13 h
Ni-MH AAA 800 mAh	14 h
Ni-MH 9V 200 mAh	9.5 h

### AVAILABLE COLORS

titanium

### BARCODE



### PACKAGING



Blister	
Plug:	TUV
Weight(g)	274
Dimensions (W) x (H) x (D) (mm)	210 x 130 x 84
Inner Carton	
Packs / Inner ctn	4
Net Weight(kg)	1.1
Gross Weight(kg)	1.3
Dimensions (L)x (W) x (H) (cm)	49.5 x 9 x 21.5
Outer Carton	
Packs / Carton	16
Net Weight(kg)	4.4
Gross Weight(kg)	7.5
Dimensions (L)x (W) x (H) (cm)	51 x 39 x 23.5
Volume(M <sup>3</sup> )	0.0467

## BC-0908

Charges:

1-4 x AA

1-4 x AAA

Ni-MH



### SPECIFICATIONS

Input: 120V ~ 60Hz or 230V ~ 50Hz  
 Output: 4 x (1.4V  $\approx$  120 mA) AA Size  
 4 x (1.4V  $\approx$  70 mA) AAA Size

### MAIN FEATURES

- 4 Independent Channels
- Reverse Polarity Protection
- LED Indicators

Red	Charging or charge complete
-----	-----------------------------

### CHARGING TIMES

Type of Battery	Charging Times (Appr.)
Ni-MH AA 2700 mAh	29 h
Ni-MH AA 2000 mAh	22 h
Ni-MH AA 1500 mAh	18 h
Ni-MH AAA 800 mAh	16 h

### AVAILABLE COLORS

Silver White

### BARCODE



### PACKAGING



Blister	
Plug:	TUV
Weight(g)	208
Dimensions (W) x (H) x (D) (mm)	200 x 125 x 52
Inner Carton	
Packs / Inner ctn	16
Net Weight(kg)	1.7
Gross Weight(kg)	1.96
Dimensions (L)x (W) x (H) (cm)	42.5 x 22.5 x 13.5
Outer Carton	
Packs / Carton	32
Net Weight(kg)	6.7
Gross Weight(kg)	8.5
Dimensions (L)x (W) x (H) (cm)	46.5 x 44 x 29
Volume(M <sup>3</sup> )	0.0594



## > Universal Chargers

These can recharge many types of batteries and are perfect for high battery usage households. They are reliable and safe and can even test your batteries to see if its time for a recharge.

### CM9398GS

#### Charges:

1- 4 AA / AAA / D / C or 1-2 9V  
Ni-MH Batteries



#### SPECIFICATIONS

Input: 230V ~ 50Hz  
Output: 4 x (1.4V  $\approx$  250mA) D/C/AA/AAA Size  
2 x (9V  $\approx$  13mA) 9V Size

#### MAIN FEATURES

- 4-channel for AAA, AA, C, D, and 2-channel for 9V batteries.
- The build-in battery change in tester.
- The timer can be selected, based on different capacity.
- Trickle charge function.
- Overcharge Protection Function.

#### CHARGING TIMES

Type of Battery	Charging Times (Appr.)
Ni-MH D 2500 mAh	24 h
Ni-MH C 3500 mAh	24 h
Ni-MH AA 2500 mAh	24 h
Ni-MH AAA 900 mAh	6 h
Ni-MH 9V 200 mAh	20 h

#### AVAILABLE COLORS

Black

#### BARCODE



## > Universal Chargers

### CM9388

#### Charges:

1- 4 AA / AAA / D / C or 1-2 9V  
Ni-MH Batteries



#### SPECIFICATIONS

##### AC To DC Adapter

Input Voltage: AC 100 ~ 240V 50/60 Hz  
Output Voltage: 12V DC 1A

##### Charger

Charging Currents  
Input: DC 12V  
Output:  
4 x (1.4V  $\approx$  300mA) D/C/AA/AAA Size  
2 x (9V  $\approx$  13mA) 9V Size

#### MAIN FEATURES

- 2 Independent Charging Channels
- To Charge AAA/AA/C/D/9V Ni-MH/Ni-Cd Rechargeable Battery
- V Detection Control
- Discharge Function
- Trickle Charge Function

#### CHARGING TIMES

Type of Battery	Charging Times (Appr.)
Ni-MH D 2500 mAh	12 h
Ni-MH C 2500 mAh	12 h
Ni-MH AA 2500 mAh	12 h
Ni-MH AAA 900 mAh	3.5 h
Ni-MH 9V 200 mAh	22 h

#### AVAILABLE COLORS

Black

#### BARCODE



#### PACKAGING



Blister	
Weight(g)	680
Dimensions (W) x (H) x (D) (mm)	330 x 175 x 60
Inner Carton	
Packs / Inner ctn	10
Gross Weight(kg)	7.32
Dimensions (L)x (W) x (H) (cm)	59 x 23.5 x 19.5
Outer Carton	
Packs / Carton	20
Net Weight(kg)	13.7
Gross Weight(kg)	16.0
Dimensions (L)x (W) x (H) (cm)	62 x 36 x 46
Volume(M³)	0.10

#### PACKAGING

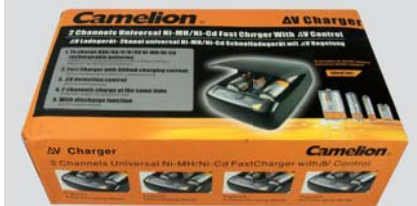

Blister	
Weight(g)	680
Dimensions (W) x (H) x (D) (mm)	275 x 155 x 88
Outer Carton	
Packs / Carton	20
Net Weight(kg)	24
Gross Weight(kg)	25.8
Dimensions (L)x (W) x (H) (cm)	56 x 47 x 35
Volume(M³)	0.0954



# CM3298

**Charges:**

1 - 4 C / D + 1 - 2 9V  
 1 - 6 AA / AAA + 1 - 2 9V  
 Ni-MH Batteries



## SPECIFICATIONS

Input: AC 100 - 240V 50Hz/60Hz 30W  
 Charging Current: 4 x C, D / DC 1,2V approx. 1.000mA  
 6 x AAA / DC 1,2V approx. 500mA  
 6 x AA / DC 1,2V approx. 1.000mA  
 2 x DC 9V approx. 70mA  
 USB 5V: approx. 500mA max.

## MAIN FEATURES

- **8 Independent Charging Channels**
- **LCD Display** Shows the charging status of each individual Battery
- **6 Level Charge Protection**
  - Δ V Cut-Off
  - Timer Control Protection (10 hours)
  - Over Temperature Protection
  - Reverse Polarity Protection
  - Over Current and Short Circuit Protection
  - Defective and Non-rechargeable battery Detection
- **USB Port**  
 Enables you to charge external devices such as MP3 players or mobile phones
- **Trickle Charge**
- **Discharge Function**  
 9V battery can not be discharged
- **Battery Refresh Function**
- **World Voltage Switch Adapter**
- **LED Indicators**

Display	LED	Explanation
		The LED continuously glows green: <b>Full charged</b>
		The LED blinks alternately red and green: The batteries are being discharged for max. 10 minutes. <b>(Refresh Function)</b>
		The LED continuously glows red: <b>Charging:</b> The batteries are being charged
		<b>Loading error:</b> The LED blinks red: The inserted batteries are not positioned correctly in the charging slot or are defective.
		<b>Check / Precharge:</b> The LED blinks green: precharge / Check the batteries

## CHARGING TIMES

Type of Battery	Charging Times (Appr.)
Ni-MH AA 2500 mAh	3.5 h
Ni-MH AAA 900 mAh	2.5 h
Ni-MH C 4000 mAh	5.5 h
Ni-MH D 4500 mAh	6.2 h
Ni-MH 9V 200 mAh	4.0 h

## AVAILABLE COLORS

Silver

## BARCODE



## PACKAGING



Box	
Plug:	TUV
Weight(g)	660
Dimensions (W) x (H) x (D) (mm)	241.5 x 60 x 215
Outer Carton	
Packs / Carton	10
Net Weight(kg)	6.6
Gross Weight(kg)	7.3
Dimensions (L)x (W) x (H) (cm)	32 x 44.5 x 24
Volume(M <sup>3</sup> )	0.0341

# LBC-312

**Charges:**

Most **1.2V 3.7V** or **7.4V Batteries\*** **Li-ion**  
**Ni-MH**



**Includes:**



AC Cord



## SPECIFICATIONS

**Charger**

Input: 100-240V ~ 50/60Hz 12W Max  
**Charging current:**  
 Lithium batteries: 3.6/3.7V 0.8A (Max)  
 7.2/7.4V 0.6A (Max )  
 Ni-MH/Ni-Cd: 2 x 1.4V = 0.7A (Max)  
 USB output: 5V = 0.5A

## MAIN FEATURES

- **Supports Many Devices** Compatible with almost all 3.7V and 7.4V Li-ion, 1.2V Ni-MH and Ni-Cd batteries for such devices as digital cameras, Camcorders, mobile phones, MP3 /MP4 players, game players and more.
- **Automatic Voltage/Polarity Selection** Microprocessor core identifies battery type and +/- polarity, making it easy for you to use.
- **Safe** Faulty battery detection; 5 hours safety timer for Ni-MH/Cd and 10 hours safety timer for Li-ion.
- **Convenient Design**
- **Portable** Lightweight design and worldwide voltage input and adapter plugs for easy traveling.
- **USB output port** for iPhone, iPod, Android Smartphone, MP3, MP4 GPS devices and more.

**LED Indicator**

CONDITIONS	CHARGING (green)	POWER (red)
No power or faulty power supply	Off	Off
Power on	Off	On
Battery charging	Flashing	On
Fully charged	On	On
Faulty battery or charging process stopped by 5/10h safety timer	Flashing	Flashing

## CHARGING TIMES

Battery Capacity	Charging Times
Ni-MH AA 2700 mAh	4.5 h
Ni-MH AA 2000 mAh	4.0 h
Ni-MH AA 1500 mAh	2.5 h
Ni-MH AAA 800 mAh	90 min

## AVAILABLE COLORS

Black

## BARCODE



## PACKAGING



**Blister**

Plug:	TUV
Weight(g)	179
Dimensions (W) x (H) x (D) (mm)	185 x 128 x 70

**Inner Carton**

Packs / Inner ctn	10
Net Weight(kg)	1.79
Gross Weight(kg)	2.14
Dimensions (L)x (W) x (H) (cm)	56.5 x 20.6 x 13.5

**Outer Carton**

Packs / Carton	40
Net Weight(kg)	7.16
Gross Weight(kg)	10.6
Dimensions (L)x (W) x (H) (cm)	58 x 42.7 x 29
Volume(M <sup>3</sup> )	0.0719

# Battery Charging Table

**Directions:**

The following table lists out charging times for specific Camelion chargers and batteries.

For example, to find the charging time for the BC-0907 charger using a Nickel Metal Hydride AA2500mah battery, first locate the BC-0907 column. Then locate the AA2500mah row. Finally, the point of intersection indicates the value, which is 80min.

Camelion Model	SBC3001		BC-0907	BC-1007		BC-0903		BC-1002A	BC-1012		
	2 cells	4 cells	DC in 12V, 1.5A	1-2 cells	3-4 cells	DC in 12V/1A	DC in 5V/1A		1-2 cells	3 cells	4 cells
Timer Control	NA	NA	1.5h	NA	NA	3.0h	6.0h	8h	6.0h	9.0h	12h
<b>Ni-MH Batteries</b>											
NH-D2500	NA	NA	NA	3h	NA	NA	NA	NA	NA	NA	NA
NH-C2500	NA	NA	NA	3h	NA	NA	NA	NA	NA	NA	NA
NH-AA2700	17h	34h	80min	3h	6h	T/C 3.0h	T/C 5.9h	T/C 8h	T/C 6h	T/C 9h	T/C 12h
NH-AA2600	16h	32h	80min	3h	5.5h	T/C 3.0h	T/C 5.6h	T/C 8h	T/C 6h	T/C 9h	T/C 12h
NH-AA2500	16h	32h	80min	2.5h	5.5h	T/C 3.0h	5.5h	T/C 8h	T/C 6h	T/C 9h	T/C 12h
NH-AA2300	15h	31h	70min	2.5h	5.5h	3.0h	5.5h	T/C 8h	T/C 6h	T/C 9h	T/C 12h
NH-AA2200	15h	29h	70min	2h	5h	2.9h	5.3h	T/C 8h	T/C 6h	T/C 9h	T/C 12h
NH-AA2000	14h	27h	60min	2h	4.5h	2.7h	4.8h	T/C 8h	T/C 6h	T/C 9h	T/C 12h
NH-AA1800	13h	26h	60min	2h	4.5h	2.4h	4.3h	T/C 8h	6h	T/C 9h	T/C 12h
NH-AA1500	10h	21h	50min	2h	3.5h	2.0h	3.6h	6h	4.5h	7h	10.5h
NH-AAA1100	6h	12h	90min	100min	4h	2.3h	3.8h	T/C 8h	T/C 6h	T/C 9h	T/C 12h
NH-AAA1000	5.5h	11h	80min	100min	3.5h	2.0h	3.4h	T/C 8h	T/C 6h	T/C 9h	T/C 12h
NH-AAA900	5h	10h	80min	70min	3.5h	1.9h	3.2h	T/C 8h	5h	T/C 9h	12h
NH-AAA800	5h	10h	70min	NA	3h	1.9h	3.2h	T/C 8h	5h	8.5h	11h
NH-AAA600	3.5h	7h	60min	NA	2.5h	1.4h	2.4h	5h	3.5h	5.5h	7h
NH-9V250	NA	NA	NA	NA	NA	NA	NA	NA	NA	NA	NA
NH-9V200	NA	NA	NA	NA	NA	NA	NA	NA	NA	NA	NA

Camelion Model	BC-1001A	BC-1021C	BC-0901	BC-0902	BC-0904S	BC-0908	CM-9398GS	CM9388	CM3298	LBC-312
Timer Control	Voltage Cut Off	12h	NA	NA	NA	NA	3/6/9/24h	NA	10h	5h
<b>Ni-MH Batteries</b>										
NH-D2500	NA	NA	NA	NA	NA	NA	14h	12h	3h	NA
NH-C2500	NA	NA	NA	NA	NA	NA	14h	12h	3h	NA
NH-AA2700	T/C 12h	T/C 12h	34h	17h	22h	29h	14h	12h	3h	4.5h
NH-AA2600	T/C 12h	T/C 12h	32h	16h	20h	27h	13h	12h	3h	4h
NH-AA2500	T/C 12h	T/C 12h	32h	16h	20h	27h	13h	12h	3h	4h
NH-AA2300	T/C 12h	T/C 12h	31h	16h	19h	26h	12h	10h	2.5h	4h
NH-AA2200	T/C 12h	T/C 12h	30h	15h	19h	25h	12h	10h	2.5h	3.5h
NH-AA2000	T/C 12h	T/C 12h	27h	14h	17h	22h	10.5h	9.5h	2.5h	3.5h
NH-AA1800	T/C 12h	T/C 12h	25h	13h	16h	21h	10h	8.5h	2h	3h
NH-AA1500	10.5h	10.5h	21h	10.5h	13h	18h	8.5h	7h	2h	2.5h
NH-AAA1100	6h	T/C 12h	14h	11h	17h	19h	4.5h	4h	2.5h	100min
NH-AAA1000	5.5h	T/C 12h	13h	10.5h	16h	18h	4.5h	3.5h	2h	100min
NH-AAA900	5h	12h	12h	10h	15h	17h	3.5h	3.5h	2h	90min
NH-AAA800	5h	11h	11h	9.5h	14h	16h	3.5h	3h	2h	90min
NH-AAA600	3.5h	8.5h	8.5h	7h	10.5h	12h	3h	2.5h	1.5h	1h
NH-9V250	11h	NA	NA	NA	11h	NA	11h	27h	4.5h	NA
NH-9V200	9.5h	NA	NA	NA	9.5h	NA	9.5h	22h	3.5h	NA

**Notes:**

NA - Not Applicable.  
 T/C: Charger has timer control. This is the cut off time, whether the battery is fully charged or not.  
 All the data is based on Camelion latest lab tests. Charging times may vary based upon temperature, product age, voltage and other conditions.  
 This data sheet is for customer reference purposes only and to help customers choose the appropriate product. Contents do not constitute a warranty.  
 For information on specific Camelion products please visit our website at [www.camelionbattery.com](http://www.camelionbattery.com) or contact us directly at [info@camelionbattery.com](mailto:info@camelionbattery.com).



**DD801**

Charge **2 USB** devices at the same time!

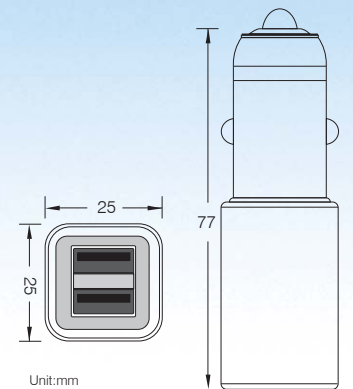

**Main Features**

- **Car Charger with Dual USB Port** Up to 5V, 2100mA direct power sources for iPad, iPod units, iPhone, mobile phones, PSP, Blackberry, Digital cameras and other music players and devices. Just plug it in to your car cigarette or plug into electric socket, power up and start to play.
- **Short Circuit Protection** Damage to the charger and mobile device is prevented in case of a short circuit.

**Specifications**

**Input:** 12 - 24V  $\overline{\text{---}}$   
**Output:** 5V  $\overline{\text{---}}$  2.1A using 1USB port  
 5V  $\overline{\text{---}}$  1A using 2USB ports

**Directions**



**Available Colors**

- Black

**Packaging**

<b>Blister</b>	<b>Plug:</b>	/
	<b>Weight(g)</b>	66
	<b>Dimensions (W) x (H) x (D)(mm)</b>	133x220x69
<b>Inner Carton</b>	<b>Packs / Inner ctn</b>	18
	<b>Net Weight(kg)</b>	/
	<b>Gross Weight(kg)</b>	/
	<b>Dimensions (L)x (W) x (H) (cm)</b>	41.5x30x23.5
<b>Outer Carton</b>	<b>Packs / Carton</b>	36
	<b>Net Weight(kg)</b>	2.4
	<b>Gross Weight(kg)</b>	3.9
	<b>Dimensions (L)x (W) x (H) (cm)</b>	48.5x31.5x43.5
	<b>Volume(cbm)</b>	0.0665

**Power Supplies**

**DD802**

Charge **Most USB** devices!



Mfi produc plan #102601-0009

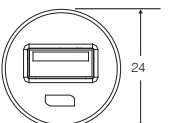
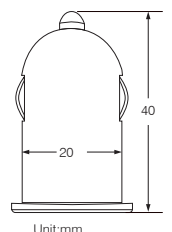

**Main Features**

- **Car Charger with USB Port** 5V, 1000mA direct power source for iPod units, iPhone, mobile phones, PSP, Blackberry, digital cameras and other music players and devices. Just plug it in to your car cigarette or plug into electric socket, power up and start to play.
- **Small and Portable** The device is smaller than standard car chargers and can be carried easily.
- **Short Circuit Protection** Damage to the charger and mobile device is prevented in case of a short circuit

**Specifications**

**Input:** 12-24V  $\overline{\text{---}}$   
**Output:** 5.0V  $\overline{\text{---}}$  1A

**Directions**



**Available Colors**

- Black

**Packaging**

<b>Blister</b>	<b>Plug:</b>	/
	<b>Weight(g)</b>	56.3
	<b>Dimensions (W) x (H) x (D)(mm)</b>	112x184x57
<b>Inner Carton</b>	<b>Packs / Inner ctn</b>	24
	<b>Net Weight(kg)</b>	/
	<b>Gross Weight(kg)</b>	/
	<b>Dimensions (L)x (W) x (H) (cm)</b>	23.1x19.1x12.4
<b>Outer Carton</b>	<b>Packs / Carton</b>	48
	<b>Net Weight(kg)</b>	2.7
	<b>Gross Weight(kg)</b>	3.9
	<b>Dimensions (L)x (W) x (H) (cm)</b>	39.6x24.5x40
	<b>Volume(cbm)</b>	0.0388

**AD5028** Easily Charge 2 USB devices at the same time!

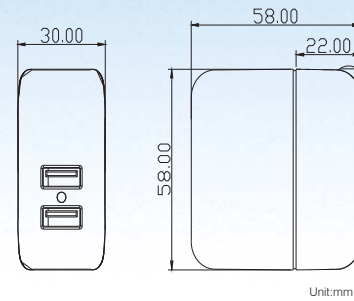

**Main Features**

- 2 USB Power Adapter
- Universal Voltage
- Handy Power Source Direct power source for iPad, iPhone, iPod, Blackberry, mobile phones, PSP, MP3/4/5, DV, PDA and other devices.
- Easy to Use: Plug it into wall socket, power up and start to play.
- Portable and Compact This unit is designed to be portable and ergonomic
- Short Circuit Protection

**Specifications**

Input: 100-240V~50/60Hz 21W max  
Output: 5V 3.4 A(2.4 A+1A)

**Directions**



**Available Colors**

White

**Packaging**

Blister	Plug:	TUV
	Weight(g)	128
	Dimensions (W) x (H) x (D)(mm)	139x221x76
Inner Carton	Packs / Inner ctn	18
	Net Weight(kg)	2.3
	Gross Weight(kg)	3.0
	Dimensions (L)x (W) x (H) (cm)	40.5x36x22.5cm
Outer Carton	Packs / Carton	36
	Net Weight(kg)	4.6
	Gross Weight(kg)	6.7
	Dimensions (L)x (W) x (H) (cm)	42.3x37.8x47
	Volume(cbm)	0.0751

**AD3127**

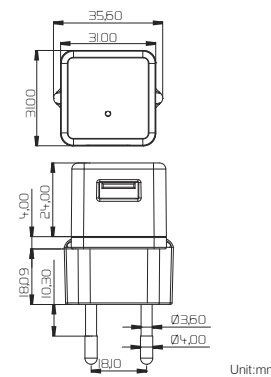

**Main Features**

- Handy Power Source 5V, 1A direct power source for iPad\*, iPod, iPhone, mobile phones, PSP, Blackberry, MP3/4, DV, PDA and other devices. Just plug it into your wall socket, power up and start to play.
- Compact Design
- Short Circuit Protection
- Overcurrent and Overheating Protection
- Global Use Options Different plug types are available depending on country requirements.

**Specifications**

Input: 100-240V~50/60Hz  
Output: 5V 1A

**Directions**



**Available Colors**

White

**Packaging**

Blister	Plug:	TUV/UL
	Weight(g)	52
	Dimensions (W) x (H) x (D)(mm)	102x167x61
Inner Carton	Packs / Inner ctn	24
	Net Weight(kg)	/
	Gross Weight(kg)	/
	Dimensions (L)x (W) x (H) (cm)	43x35x12
Outer Carton	Packs / Carton	48
	Net Weight(kg)	2.9
	Gross Weight(kg)	3.9
	Dimensions (L)x (W) x (H) (cm)	44.5x37.5x27.5
	Volume(cbm)	0.0459

**PS625F**



**Main Features**

- Multiple intelligent safety protections
- Built-in LED flashlight
- Works with your existing cables
- Compatible with most mobile devices
- Easy to read power indicator
- Convenient carrying size
- Powered by Samsung battery cell

**Specifications**

Battery Capacity: 2600mAh/2800mAh Lithium-ion Battery  
Power Input: Micro USB 5V 1A  
Power Output: 5V 1A

**Directions**

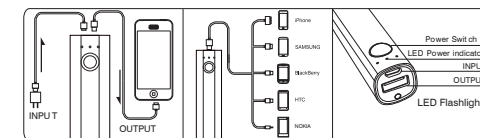

**Available Colors**

Red  silver

**Packaging**

Blister	Plug:	/
	Weight(g)	116
	Dimensions (W) x (H) x (D)(mm)	80x31x183
Inner Carton	Packs / Inner ctn	12
	Net Weight(kg)	/
	Gross Weight(kg)	/
	Dimensions (L)x (W) x (H) (cm)	38.0x19.3x8.8
Outer Carton	Packs / Carton	48
	Net Weight(kg)	5.57
	Gross Weight(kg)	6.27
	Dimensions (L)x (W) x (H) (cm)	39.5x36.5x21.5
	Volume(cbm)	0.0309

**PS626**



Accessories:  
1 x USB Cable (L:50cm)  
1 x Pouch



LED Status (● ON ○ OFF)	Capacity
● ● ● ●	75%-100%
○ ● ● ●	75%-50%
○ ○ ● ●	50%-25%
○ ○ ○ ●	<25%

**Main Features**

- Multiple intelligent safety protections
- Over charge protection
- Over discharge protection
- Over current protection
- Short circuit protection
- Works with your existing cables
- Compatible with most mobile devices
- Easy to read power indicator

**Specifications**

Battery Capacity: 4400mAh Lithium-ion Battery  
Power Input: Micro USB 5V 1A (max)  
Power Output: 5V 1A (max)

**Directions**



**Available Colors**

Blue  Gold

**Packaging**

Blister	Plug:	/
	Weight(g)	194
	Dimensions (W) x (H) x (D)(mm)	110x27x205
Inner Carton	Packs / Inner ctn	10
	Net Weight(kg)	/
	Gross Weight(kg)	/
	Dimensions (L)x (W) x (H) (cm)	27.2x21.5x13
Outer Carton	Packs / Carton	40
	Net Weight(kg)	7.8
	Gross Weight(kg)	9.2
	Dimensions (L)x (W) x (H) (cm)	55.5x29x23.5
	Volume(cbm)	0.0378



## PS627



Accessories:  
1 x USB Cable  
(L:50cm)  
1 x Pouch



LED Status (● ON ○ OFF)	Capacity
● ● ● ●	75%-100%
○ ● ● ●	75%-50%
○ ○ ● ●	50%-25%
○ ○ ○ ●	<25%

### Main Features

- Multiple intelligent safety protections  
Over charge protection  
Over discharge protection  
Over current protection  
Over current protection  
Short circuit protection
- Works with your existing cables
- Compatible with most mobile devices
- Easy to read power indicator

### Specifications

**Battery Capacity:** 6600mAh Lithium-ion Battery  
**Power Input:** Micro USB 5V 1A (max)  
**Power Output:** 5V 1A (max)

### Directions



### Available Colors

Gold

### Packaging

Blister	Plug:	/
	Weight(g)	262
	Dimensions (W) x (H) x (D)(mm)	110x27x205
Inner Carton	Packs / Inner ctn	10
	Net Weight(kg)	/
	Gross Weight(kg)	/
	Dimensions (L)x (W) x (H) (cm)	27.2x21.5x13
Outer Carton	Packs / Carton	40
	Net Weight(kg)	10.5
	Gross Weight(kg)	11.9
	Dimensions (L)x (W) x (H) (cm)	55.5x29x23.5
	Volume(cbm)	0.0378

## Flashlights & Lanterns

### Device Chart

BEST  YES  NO

		Camelion Power Supplies						
USB Enable Devices		AD5028	AD3127	DD801	DD802	PS625F	PS626	PS627
Mobile & Professional	iPhone 4/4S/5	✓	✓	✓	✓	✓	✓	✓
	iPod®	✓	✓	✓	✓	✓	✓	✓
	iPad®	✓	✓	✓	✓	✓	✓	✓
	iTouch®	✓	✓	✓	✓	✓	✓	✓
	PDA	✓	✓	✓	✓	✓	✓	✓
	Samsung	✓	✓	✓	✓	✓	✓	✓
	Sony	✓	✓	✓	✓	✓	✓	✓
	HTC	✓	✓	✓	✓	✓	✓	✓
	Blackberry®	✓	✓	✓	✓	✓	✓	✓
	Nokia	✓	✓	✓	✓	✓	✓	✓
	LG	✓	✓	✓	✓	✓	✓	✓
	Sharp	✓	✓	✓	✓	✓	✓	✓
	Motorola	✓	✓	✓	✓	✓	✓	✓
	Smart Phone	✓	✓	✓	✓	✓	✓	✓
	Playstations	✓	✓	✓	✓	✓	✓	✓
Tablet	✓	✓	✓	✓	✓	✓	✓	
Others	MP3/MP4/MP5	✓	✓	✓	✓	✓	✓	✓
	CD/DVD	✓	✓	✓	✓	✓	✓	✓
	Loudspeaker	✓	✓	✓	✓	✓	✓	✓
	AM/FM Radio	✓	✓	✓	✓	✓	✓	✓
	Digital Camera	✓	✓	✓	✓	✓	✓	✓
	GPS	✓	✓	✓	✓	✓	✓	✓
	USB battery charger	✓	✓	✓	✓	✓	✓	✓
	Electric shaver	✓	✓	✓	✓	✓	✓	✓

**Remark:**  
1. The capacity of the iPad battery must be not less than 5%.  
2. Apply for USB 2.0 or lower version only.  
3. Camelion accepts no responsibility for any accidents resulting from use of this information.

# TUFFeLite™ Flashlights

Maximum Illumination in a Professional, Durable Design



- CREE® XR-E 3W LED Up to 5 km visibility and 200 meters effective range
- Unbreakable Anodized Aircraft Aluminum Alloy
- Water Resistant O-Ring and sealed switch design
- Shock Resistant and Weatherproof
- Adjustable focus for different usage

- Best for:**
- Security, police, military, emergency response
  - Ideal for work, outdoor and general purpose activities

Specifications									
Product Picture	Name	Model #	LEDs	LED Type	Lumens	Battery Mode	Body Material	Available Colors	Water Resistant
	TUFFeLite™ Professional Flashlight	T7071	1+6	CREE® XP-E 3W LED	120	3 x AAA	Aircraft aluminum	Black	✓
	TUFFeLite™ Professional Flashlight	T7012	1	CREE® XR-E 3W LED	120	3 x AAA	Aircraft aluminum	Black	✓
	TUFFeLite™ Professional Flashlight	T5	1	CREE® XR-E 3W LED	120	3 x AAA	Aircraft Aluminum	Black	✓

### 3 Lighting Modes (T7071)



### 3 Lighting Modes (T7012)

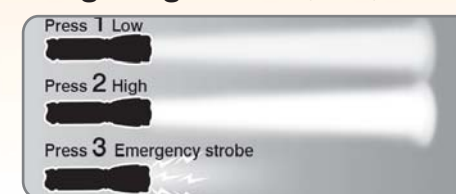

Exceptional Illumination

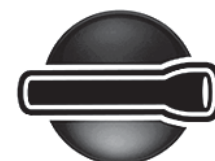

Aircraft Aluminium Alloy

### T7071



CREE® XR-E 3W LED

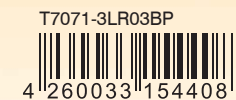

### T7012



CREE® XR-E 3W LED



### T5



CREE® XR-E 3W LED



Pack. Picture	Name	Item #	Packaging Type	Included Batteries	Packaging Details										
					Blister/Box Details				Outer Carton Details						
					Dimensions (mm)			Net Weight (g)	Packs/ Carton	Dimensions (cm)			Volume (M <sup>3</sup> )	Gross Weight (Kg)	Net Weight (kg)
L Length	W Width	D Depth		L Length	W Width	D Depth									
	TUFFeLite™ Professional Flashlight	T7071-3LR03BP	Blister Pack	3 x AAA	250	150	42	263	24	47.5	31.0	27.5	0.0405	7.4	6.3
	TUFFeLite™ Professional Flashlight	T7012-3LR03BP	Blister Pack	3 x AAA	250	150	38	193	24	47.5	31.0	27.5	0.0405	5.7	4.6
	TUFFeLite™ Professional Flashlight	AL3W3LR03-05	Blister Pack	3 x AAA	250	150	40	179	24	47.5	29.7	27.5	0.0388	5.4	4.3



# TRAVLite™ Flashlights

ideal Lighting for Out of Doors



## Pocket LED Flashlight

- Ultra Shock Resistant TPE Casing Up to 3 meters drop height
- Up to 40 hrs continuous Lighting\*
- "O" Ring and Sealed Switch for water resistant (IPX4\*\*) performance
- Slim, Smart Portable Design includes lanyard, great for travel
- Uses Easily Available Economical AAA Batteries



## LED Rubber Flashlights

- Heavy Duty Rubberized Case
- Shockproof up to 2 meters drop
- Water Resistant (up to IPX7\*\*\*)
- Shatterproof Optical Lens
- Non Slip Grip oil/grease resistant grip with push button switch and end strap
- Never replace LEDs 100,000 hr lifetime
- Brightness Intensifying Optical Cavity Design

**Best for:**  
Traveling, hiking, camping, fishing, athletics

\*Camelion 2009 lab tests, using 3 Camelion alkaline AAA batteries; LED brightness will attenuate when battery power is weak.  
\*\*An IPX4 designation means it will hold up against rain and jets of water, but is not suitable for swimming or guaranteed to survive immersion in water.  
\*\*\*An IPX7 designation means the case can withstand accidental immersion in one meter of water for up to 30 minutes.

Product Picture	Name	Model #	Specifications						
			LEDs	LED Type	Lumens	Battery Mode	Body Material	Available Colors	Water Resistant
	Pocket LED Flashlights	HP7011	1	Superbright LED	40lm	3 x AAA	Plastic	Red Green	✓
	Rubber Flashlights	PT6L2D	6	Superbright LED	12lm	2 x D	Rubber	Red Blue	✓
	Rubber Flashlights	PT3L2AA	3	Superbright LED	6lm	2 x AA	Rubber	Red Blue	✓

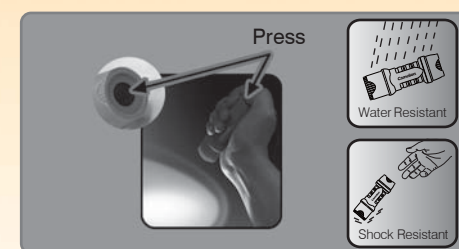

HP7011

Up to 40 Hrs Continuous use  
CE



HP7011-3R03BP  
4 260216 450136



HP7011D24  
4 260216 452659

6 LED

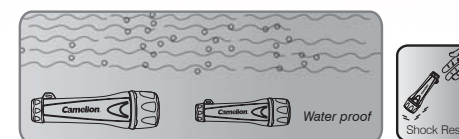

PT6L2D

Up to 300 Hrs Continuous use  
CE



PT6L2D-2R20BP  
4 260216 452840



3 LED

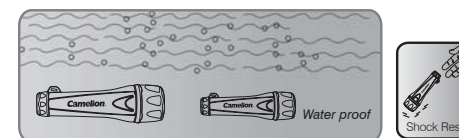

PT3L2AA

Up to 75 Hrs Continuous use  
CE



PT3L2AA-2R6PBP  
4 260216 452833



### Packaging Details

Pack. Picture	Name	Item#	Packaging Type	Included Batteries	Blister/Box Details										
					Dimensions (mm)			Net Weight (g)	Packs/ Carton	Outer Carton Details			Gross Weight (Kg)	Net Weight (kg)	
					L Length	W Width	D Depth			L Length	W Width	D Depth			Volume (M <sup>3</sup> )
	Pocket LED Flashlights	HP7011-3R03BP	Double Blister	3 x R03P	110	190	40	96.5	48	51.5	21.5	26.5	0.0294	6.4	4.7
		HP7011-3R03PD24	Display Box	3 x R03P	303	206	110	2036	4	46	34	25	0.0391	9.3	8.2
		HP7011D24	Display Box	—	303	206	110	1496	4	46	34	25	0.0391	7.1	6.0
	Rubber Flashlights	PT6L2D-2R20BP	Double Blister	2 x R20P	305	175	70	446	24	50.5	45	33	0.0750	11.7	10.7
	Rubber Flashlights	PT3L2AA-2R6PBP	Double Blister	2 x R6P	248	120	50	161	48	49.5	36	33	0.0588	8.7	7.7



**Mini Area Lantern**

- **Dual Lighting Modes** High beam / Low beam.
- **Handy** Easy to hang with the lanyard or seat on a specially designed base.
- **Comfortable** Frosted shade lighting tube and rubber boot switch.
- **Long Lifespan LED** provides outstanding illumination and free of replacement.
- **Energy Saving** Up to 80% more than a krypton light bulb.

**LED Lantern**

- **Effective Lighting** 360° lighting with light diffuser.
- **LED Technology** The high lumen LED provides outstanding illumination, high energy efficiency, and up to 30,000 hours lifetime.
- **Standby Yellow LED** to save energy costs.
- **Handy** Easy grip, adjustable handle with hook.
- **Durable Construction** Slim with non-topple base.
- **2 Lighting Modes** Night Light and Full Beam lighting modes for different situations.
- **Rubber boot switch**

**Mini LED Lantern**

- 0.5W high lumen LED lantern
- Use up to 35 hours runtime\*
- 360° effective lighting
- Compact design

**Best for:**  
Camping, outdoors, children's quarters

Product Picture	Name	Model #	Specifications						
			LEDs	LED Type	Lumens	Battery Mode	Body Material	Available Colors	Water Resistant
	Mini Area Lantern	SL7051	1	1W LED	36/18lm	4 x AAA	Plastic	Green	X
	LED Lantern	SL1011	1	1W LED	70lm	3 x D	Plastic	Green	X
	Mini LED Lantern	SL2011	1	0.5W LED	35lm	4 x AA	Plastic	Red Yellow	X

**Mini Area Lantern**



**SL7051**

**2 Mode**  
Lighting Modes  
**up to 12 Hrs**  
continuous use



SL7051-4R03PBP  
4 260033 115570 2



SL7051D12  
4 260216 1145264 2



**SL1011**

**up to 180 hours\***  
continuous lighting

**2 Mode**  
Lighting Modes  
**Up to 30,000**  
Hours LED Lifetime  
**360°**  
Effective Lighting



SL1011  
4 260216 1145244 1



**SL2011**

**up to 35 hours**  
continuous lighting

**35 lumens**  
**Up to 30,000**  
Hours LED Lifetime  
**360°**  
Effective Lighting



SL2011-4R6PCB  
4 260216 1454110



SL2011-4R6PD6  
4 260216 1454127

Pack. Picture	Name	Item#	Packaging Type	Included Batteries	Packaging Details										
					Blister/Box Details				Outer Carton Details						
					L Length	W Width	D Depth	Net Weight (g)	Packs/ Carton	L Length	W Width	D Depth	Volume (M <sup>3</sup> )	Gross Weight (Kg)	Net Weight (kg)
	Mini Area Lantern	SL7051-4R03PBP	Double Blister	4 x R03P	202	125	55	300	24	33.7	29.8	47.6	0.0480	8.7	7.2
		SL7051D12	Display Box	—	285	220	150	900	4	47.5	31.5	33.5	0.0502	4.5	3.6
	LED Lantern	SL1011	Box	—	125	125	205	600	12	43.4	27.2	40.5	0.0478	8.6	7.2
	Mini LED Lantern	SL2011-4R6PCB	Box	4 x R6P	112	112	138	236	24	46.8	35.5	30	0.0498	6.3	
		SL2011-4R6PD6	Display Box	4 x R6P	240	227	238	1390	24	47.5	36	30	0.0513	6.2	



# SuperBright™ Flashlights

LED Flashlights for Home or Outdoor Use



## Multi-head LED Classic Flashlights

- **Cloverleaf Reflector System** for maximum focus and intensity
- **Energy Saving LEDs** up to 5 times brighter, 8 times more efficient than regular krypton bulbs\*
- **Long Service Life** Up to 180 hours continuous lighting\*
- **Never Replace LEDs** 100,000h LED lifetime
- **Handy Grip** with hooks, anti-roll design

### Best for:

- Indoor and/or outdoor use
- Handy for camping, travel, fishing
- Household use, walking the dog

\*Camelion 2009 Lab Tests. Performance subject to battery, temperature and ambient lighting conditions.

Product Picture	Name	Model #	Specifications						
			LEDs	LED Type	Lumens	Battery Mode	Body Material	Available Colors	Water Resistant
	Multi-Head LED Classic Flashlights	FL6L2D	6	Superbright LED	12lm	2 x D	Plastic	Yellow	✓
	Multi-Head LED Classic Flashlights	FL3L2AA	3	Superbright LED	6lm	2 x AA	Plastic	Yellow	✓

100,000  
Hours  
LED  
Life Time



## FL6L2D

Up to  
180 Hrs  
Continuous use

6LED



FL6L2D2R20P  
4 2 6 0 2 1 6 1 4 5 2 7 9 6

## FL3L2AA

Up to  
35 Hrs  
Continuous use

3LED



FL3L2AA2R6P  
4 2 6 0 0 3 3 1 5 4 7 2 9

Pack. Picture	Name	Item#	Packaging Type	Included Batteries	Packaging Details										
					Blister/Box Details				Outer Carton Details						
					Dimensions (mm)			Net Weight (g)	Packs/Carton	Dimensions (cm)			Volume (M <sup>3</sup> )	Gross Weight (Kg)	Net Weight (kg)
L	W	D	L	W	D										
	Multi-Head LED Classic Flashlights	FL6L2D2R20P	Blister Pack	2 x R20P	264	144	40	285	24	55.5	42.5	18.5	0.0436	8.3	7.4
	Multi-Head LED Classic Flashlights	FL3L2AA2R6P	Blister Pack	2 x R6P	210	98	30	87	60	40	30	23	0.0276	5.8	5.2

# SuperBright™ Searchlamps

LED Search lamps for Home or Outdoor Use



## Multi-head LED Search lamps

- **Powerful** Lights distances up to 150 meters\*
- **Cloverleaf Reflector System** for maximum focus and intensity
- **Energy Saving LEDs** up to 5 times brighter, 8 times more efficient than regular krypton bulbs\*
- **Long Service Life** Up to 500 hours continuous lighting\*
- **Never Replace LEDs** 100,000h LED lifetime
- **Handy Grip** with hooks, anti-roll design

### Best for:

- Indoor and/or outdoor use
- Military, security, campus, factory, emergency kits
- Vehicle use, garages, auto service use
- Handy for camping, travel, fishing

\*Camelion 2009 Lab Tests. Performance subject to battery (alkaline), temperature and ambient lighting conditions.

Product Picture	Name	Model #	Specifications						
			LEDs	LED Type	Lumens	Battery Mode	Body Material	Available Colors	Water Resistant
	Multi-Head LED Search lamps	FL-16LED	16	Super Bright LED	32lm	4 x D/ 1 x 4R25	Plastic	Yellow	✓
	Multi-Head LED Search lamps	FL-9LED	9	Super Bright LED	18lm	4 x AA	Plastic	Yellow Blue	✓

16LED

FL-16LED

Up to  
500 Hrs  
Continuous use



CE



FL-16LED-4R20PCB



4 2 6 0 0 3 3 1 5 5 5 0 4

FL-9LED

9LED

Up to  
150 Hrs  
Continuous use



CE



FL-9LED-4R6P



4 2 6 0 0 3 3 1 5 5 4 8 1

Pack. Picture	Name	Item#	Packaging Type	Included Batteries	Packaging Details										
					Blister/Box Details				Outer Carton Details						
					Dimensions (mm)			Net Weight (g)	Packs/ Carton	Dimensions (cm)			Volume (M <sup>3</sup> )	Gross Weight (Kg)	Net Weight (kg)
L Length	W Width	D Depth	L Length	W Width	D Depth										
	Multi-Head LED Search lamps	FL-16LED-4-R20PCB	Box	—	250	123	135	708	12	52	39	30	0.0608	10.6	9.6
	Multi-Head LED Search lamps	FL-9LED-4R6P	Shrink pack	4 x R6P	100	146	110	278	36	59	54	24	0.0765	12.0	10



# SuperBright™ Flashlights

Budget Flashlights for Everyday Use



## Classic Flashlights

- Super bright and replaceable LED bulb
- 35 lumens of light
- Long battery service life
- Many Color Options

### Best for:

- Indoor & outdoor usage
- Household use

Product Picture	Name	Model #	Specifications					
			Bulb Type	Lumens	Battery Mode	Body Material	Available Colors	Water Resistant
	Classic Flashlights	FL1L2D	LED	35lm	2 x D	Plastic	<div style="display: flex; flex-direction: column; gap: 2px;"> <span><span style="color: red;">■</span> Red</span> <span><span style="color: yellow;">■</span> Yellow</span> <span><span style="color: blue;">■</span> Blue</span> <span><span style="color: black;">■</span> Black</span> </div>	✗
	Classic Flashlights	FL1L2C	LED	35lm	2 x C	Plastic	<div style="display: flex; flex-direction: column; gap: 2px;"> <span><span style="color: red;">■</span> Red</span> <span><span style="color: yellow;">■</span> Yellow</span> <span><span style="color: blue;">■</span> Blue</span> <span><span style="color: black;">■</span> Black</span> </div>	✗
	Classic Flashlights	FL1L2AA	LED	35lm	2 x AA	Plastic	<div style="display: flex; flex-direction: column; gap: 2px;"> <span><span style="color: red;">■</span> Red</span> <span><span style="color: yellow;">■</span> Yellow</span> <span><span style="color: blue;">■</span> Blue</span> <span><span style="color: black;">■</span> Black</span> </div>	✗

**1 LED**

FL1L2D



FL1L2DB2R20P  
4 260033 154200



FL1L2DD12  
4 260033 154330

**1 LED**

FL1L2C



FL1L2CB2R14P  
4 260033 154217

**1 LED**

FL1L2AA



FL1L2AAB2R6P  
4 260033 154224



FL1L2AAD24  
4 260033 154323

Pack. Picture	Name	Item#	Packaging Type	Included Batteries	Packaging Details										
					Blister/Box Details				Outer Carton Details						
					Dimensions (mm)			Net Weight (g)	Packs/ Carton	Dimensions (cm)			Volume (M³)	Gross Weight (Kg)	Net Weight (kg)
L	W	D	Length	Width	Depth	Length	Width	Depth	Length	Width	Depth	Length	Width	Depth	
	Classic Flashlights	FL1L2DB2R20P	Blister Pack	2 x R20P	292	158	64	312	24	46	31.5	31	0.0449	9.0	7.5
		FL1L2DD12	Display boxr	—	250	188	195	1332	4	51.5	40	21.5	0.0443	7.0	5.3
	Classic Flashlights	FL1L2CB2R14P	Blister Pack	2 x R14P	240	131	50	170	24	47	26	20	0.0244	4.1	5.0
	Classic Flashlights	FL1L2AAB2R6P	Blister Pack	2 x R6P	211	99	38	84	60	40	30	23	0.0276	6.0	5.3
		FL1L2AAD24	Display boxr	—	230	154	150	1116	8	48	33	32.5	0.0515	10.5	8.9

# HomeBright™ Search Lamps

Budget Search Lamps for Everyday Use



### Search Lamps

- Economical
- General purpose
- Impact Resistant Plastic
- Many Color Options
- Krypton or Vacuum bulb

### Best for:

- Indoor & outdoor usage
- Military, security, campus, factory, emergency kits
- Vehicle use, garages, auto service use
- Handy for camping, travel, fishing



Specifications								
Product Picture	Name	Model #	Bulb Type	Voltage/Ampere	Battery Mode	Body Material	Available Colors	Water Resistant
	HomeBright Search Lamps	CM25B1	Krypton	4.8V/750mA	1 x 4R25	Plastic	Red	✗
	HomeBright Search Lamps	CM4AA01	Krypton	4.8V/750mA	4 x AA	Plastic	Yellow Blue	✓

Packaging Details															
Pack. Picture	Name	Item#	Packaging Type	Included Batteries	Blister/Box Details				Outer Carton Details						
					Dimensions (mm)			Net Weight (g)	Packs/ Carton	Dimensions (cm)			Volume (cbm)	Gross Weight (Kg)	Net Weight (kg)
					L Length	W Width	D Depth			L Length	W Width	D Depth			
	HomeBright Search Lamps	CM25B1	Shrink Pack	1 x 4R25	255	110	115	800	12	53	32.5	28.5	0.0491	12.5	9.6
	HomeBright Search Lamps	CM4AA01-4R6P	Shrink Pack	4 x R6P	100	146	110	278	36	59	54	24	0.0765	12.0	10.0

# Penlight Flashlights

An Elegant Gift and a Handy Tool



- Powerful Spot Beam
- Durable Aircraft Aluminum
- Strong Pocket Clip
- Push Button Switch

### Best for:

- Useful tool for doctors
- Elegant, fashionable gift
- Great for hard to reach recesses and gaps



Specifications								
Product Picture	Name	Model #	Bulb Type	Voltage/Ampere	Battery Mode	Body Material	Available Colors	Water Resistant
	Penlight Flashlight	DL2AAAS	Vacuum	2.2V/250mA	2AAA	Aircraft aluminum	Silver	✗

Packaging Details															
Pack. Picture	Name	Item#	Packaging Type	Included Batteries	Blister/Box Details				Outer Carton Details						
					Dimensions (mm)			Net Weight (g)	Packs/ Carton	Dimensions (cm)			Volume (M³)	Gross Weight (Kg)	Net Weight (kg)
					L Length	W Width	D Depth			L Length	W Width	D Depth			
	Penlight Flashlight	DL2AAAS	Blister Pack	2 x R03P	200	155	115	56	100	48.5	39.0	25.0	0.0479	5.6	7.0



# CT-Series LED Flashlights



## High grade aluminium flashlight with maximum illumination

- High Performance Chip Module SMD Technology
- Unbreakable Anodized Aluminium Alloy
- Ultra-High Luminosity

- Best for:**
- Security, police, military, emergency response
  - Ideal for work, outdoor and general purpose activities

Product Picture	Name	Model #	Specifications						
			LEDs	LED Type	Lumens	Battery Mode	Body Material	Available Colors	Water Resistant
	3 Watt Flashlight with S.O.S. Function	CT4002	1	High-power-chip SMD Technology	120lm	3 x AAA	Aluminium	Black	✗
	9 LED Flashlight	CT4004	9	LED Technology	120lm	3 x AAA	Aluminium	Black Silver	✗
	30 LED Flashlight	CT4005	30	LED Technology	120lm	2 x D	Aluminium	Black	✗
	3 Watt Flashlight	CT4010	1	High-power-chip SMD Technology	130lm	3 x AAA	Aluminium	Silver	✗

CT4002

**3 Watt LED**



CE



CT4004

**9 LED**



CE



CT4005

**30 LED**



CE



CT4010

**3 Watt LED**



CE



Pack. Picture	Name	Item#	Packaging Type	Included Batteries	Packaging Details										
					Blister/Box Details				Outer Carton Details						
					Dimensions (mm)			Net Weight (g)	Packs/ Carton	Dimensions (cm)			Volume (M <sup>3</sup> )	Gross Weight (Kg)	Net Weight (kg)
L Length	W Width	D Depth	L Length	W Width	D Depth										
	3 Watt Flashlight with S.O.S. Function	CT4002	Double blister	3 x LR03	244	123	40	191.6	120	51	38	56	0.1085	20	19
	9 LED Flashlight	CT4004	Double blister	3 x LR03	244	123	40	149.9	120	51	38	56	0.1085	20	19
	30 LED Flashlight	CT4005	Double blister	—	345	180	60	397.3	40	74	45	30.5	0.1016	17	16
	3 Watt Flashlight	CT4010	Double blister	3 x LR03	242	121	35	153.8	120	51	38	56	0.1085	20	19

# CT-Series LED Flashlights

Best Lighting for Outdoors



## LED Lantern

Key Features	Solar Lantern	1 Watt Table Lantern
Lighting Mode	100 % / 50 %	100 % / 50 % /Flashing
Long Life Use	3 h	17 h
Key Applications	Outdoors, Camping,Travel	

- Effective Lighting
- LED Technology provides outstanding Illumination and high efficiency
- Handy Easy grip, adjustable handle with hook
- Rubber bootted push switch

## 3 Watt Headlight

- High Performance Chip Module SMD Technology
- Low Power Consumption
- Ultra-High Luminosity
- 3 different LED mode

**Best for:**  
Camping, Outdoors, Caving

## 2 + 1 LED Solar Keychain

- 3 LEDs (2 LEDs for light, 1 LED as money detector)
- Solar Panel collects not only energy by UV light, but also by warm white room light

**Best for:**  
general use

Product Picture	Name	Model #	Specifications						
			LEDs	LED Type	Lumens	Battery Mode	Body Material	Available Colors	Water Resistant
	36 LED Solar Lantern	Solar Lantern	36	LED Technology	up to 100lm	4 x D / inbuild rechargeable battery	Rubberized Aluminium	Black	✗
	1 Watt LED Table Lantern	CT4008	1	High-power-chip SMD Technology	70lm	4 x AA	Rubberized Aluminium	Black	✗
	3 Watt LED Headlight	CT4007	1	High-power-chip SMD Technology	130lm	3 x AAA	Plastic	Black	✗
	2+1 LED Solar Keychain	CT4011	3	LED Technology	50lm	1 x LIR2032	Plastic	Black	✗

## Solar Lantern

36 LED



Solar Lantern  
4 260030 255474

## CT4008

### 1 Watt Table Lantern



CT4008  
4 260030 255771

## CT4007

### 3 Watt Headlight

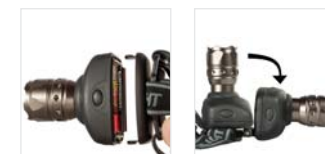

CT4007  
4 260030 255764

## CT4011

### 2+1 LED Solar Keychain



CT4011  
4 260030 255801

Pack. Picture	Name	Item#	Packaging Type	Included Batteries	Packaging Details										
					Blister/Box Details				Outer Carton Details						
					Dimensions (mm)			Net Weight (g)	Packs/ Carton	Dimensions (cm)			Volume (M <sup>3</sup> )	Gross Weight (Kg)	Net Weight (kg)
	36 LED Solar Lantern	Solar Lantern	Hardbox	—	L	W	D	Net Weight (g)	Packs/ Carton	L	W	D	Volume (M <sup>3</sup> )	Gross Weight (Kg)	Net Weight (kg)
					Length	Width	Depth			Length	Width	Depth			
	1 Watt LED Table Lantern	CT4008	Double blister	—	265	140	140	681.7	24	57.5	43.5	37.5	0.0938	23	20
	3 Watt LED Headlight	CT4007	Double blister	3 x LR03	242	123	50	164.7	100	57	54.5	36	0.1119	21.5	18.5
	2+1 LED Solar Keychain	CT4011	Double blister	1 x LIR2032	245	125	100	150.5	100	52	38	58.5	0.1156	15.5	13.5
					162	105	18	32.2	240	53.5	36.5	38.5	0.0752	10.5	9.5



# HyberBrite™ Rechargeable Flashlights

## Maximum Illumination and Durable Design



- **CREE® XR-E 3W LED** Up to 5 km visibility and 200 meters effective range
- **Rechargeable** up to 1000 times
- **Long Lasting** Up to 45 hours on a charge
- **Outstanding Thermal Management** for safe recharging and lighting
- **Virtually Unbreakable, Corrosion and Shock Resistant** Aircraft aluminum alloy
- **Water resistant** Rubber O-ring protection and sealed switch design
- **Easy Grip Handle With Anti-Roll Head**
- **Concealed Recharging Socket**

- Best for:**
- Security, Police, Military, Emergency response
  - Ideal for professional work, campus, factory, outdoor and general purpose activities

**3 WATT LED**  
CREE® XR-E

**100000 Hrs**  
LED life time

**Rechargeable**

**Aircraft aluminum**

**High Illumination**

**3 Lighting Modes**



**5 WATT LED**  
CREE® XR-E

**3 Lighting Modes (RT3071)**



**T7**  
Up to 9 Hrs  
CE  
4 260216 452710  
AL3W3NH-D2500BP07

**T8**  
Up to 9 Hrs  
CE  
4 260216 452727  
AL3W3NH-C2500BP08

**T9**  
Up to 6.5 Hrs  
CE  
4 260216 452734  
AL3W3NH-SC2000BP09

**T10**  
Up to 45 Hrs  
CE  
4 260216 452741  
AL3W3NH-D2500CB10

**RT3071**  
Up to 8 Hrs  
CE  
4 260216 452758  
RT3071-3NH2000CB

Product Picture	Name	Model #	Flashlight Specifications							Charger Specification		
			LED Type	LEDs	Battery Mode	Body Material	Available Colors	Water Resist	Operating Time	Input	Ouput	Charging Time
	Rechargeable Flashlight	T7	CREE® XR-E 3W LED	1	3 x NH-D2500	Aircraft aluminum	Black	✓	9 hrs	100-240~50/60Hz	4.2 ~ 500mA	6 hrs
	Rechargeable Flashlight	T8	CREE® XR-E 3W LED	1	3 x NH-C2500	Aircraft aluminum	Black	✓	9 hrs	100-240~50/60Hz	4.2 ~ 500mA	6 hrs
	Rechargeable Flashlight	T9	CREE® XR-E 3W LED	1	3 x NH-SC2000	Aircraft aluminum	Black	✓	6.5 hrs	100-240~50/60Hz	4.2 ~ 500mA	4.8 hrs
	Rechargeable Flashlight	T10	CREE® XR-E 3W LED	1	3 x NH-D2500	Aircraft aluminum	Black	✓	High: 4 hrs Medium: 12 hrs Low: 45 hrs	100-240~50/60Hz	4.2 ~ 500mA	6 hrs
	Rechargeable Flashlight	RT3071	CREE® XR-E 3W LED	1	3NH-SC2000	Aircraft aluminum	Black	✓	8 hrs	100-240~50/60Hz	4.2 ~ 500mA	4.8 hrs

**Packaging Details**

Pack. Picture	Name	Item#	Packaging Type	Included Batteries	Blister/Box Details				Outer Carton Details						
					Dimensions (mm)			Net Weight (g)	Packs/ Carton	Dimensions (cm)			Volume (M³)	Gross Weight (Kg)	Net Weight (kg)
					L	W	D			L	W	D			
	Rechargeable Flashlight	AL3W3NH-D2500BP07	Box	3 x NH-D2500	321	150	72	870	8	34	32	32	0.0349	7.0	6.2
	Rechargeable Flashlight	AL3W3NH-C2500BP08	Box	3 x NH-C2500	294	144	72	790	8	31.5	30.5	32.5	0.0313	7.5	6.3
	Rechargeable Flashlight	AL3W3NH-SC2000BP09	Box	3 x NH-SC2000	268	130	62	575	8	29	28	28.5	0.0232	5.2	4.6
	Rechargeable Flashlight	AL3W3NH-D2500CB10	Box	3 x NH-D2500	321	150	72	775	8	34	32	32	0.0349	8.5	7.4
	Rechargeable Flashlight	RT3071-3NHSC-2000CB	Box	3NH-SC2000	268	130	62	588	8	29	28	28.5	0.0232	5.3	4.7

# Flashlights Replacement Bulbs

## LED

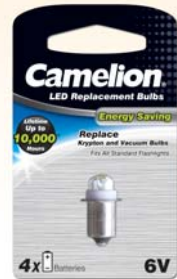

### Specifications

Model No.	Lamp Type	Voltage (V)	Current (mA)	Power (W)	Luminous Flux (lm)	Color Temperature (K)	Base Type	Average Life (hrs)	Battery Type
BL304 WN	LED Flashlight Bulb	3.0	130	0.4	30	6000--8000 (Cool White)	P 13.5S	10,000	2x(AA/AAA/D/C)
BL304 WR						3500--4000 (Warm White)			
BL406 WN	LED Flashlight Bulb	4.5	130	0.6	38	6000--8000 (Cool White)	P 13.5S	10,000	3x(AA/AAA/D/C) 3LR12,3R12
BL406 WR						3500--4000 (Warm White)			
BL608 WN	LED Flashlight Bulb	6.0	130	0.8	42	6000--8000 (Cool White)	P 13.5S	10,000	4x(AA/AAA/D/C), 4R25
BL608 WR						3500--4000 (Warm White)			

### Packaging Details

Pack. Picture	Name	Item #	Packaging Type	Blister/Box Details									Outer Carton Details		
				Dimensions (mm)			Net Weight (g)	Packs/ Carton	Dimensions (cm)			Volume (M <sup>3</sup> )	Gross Weight (Kg)	Net Weight (kg)	
				L Length	W Width	D Depth			L Length	W Width	D Depth				
	LED Replacement Bulbs	BL304WN-BP1	Blister Pack	92	55	14	6	480	30.5	30	24.8	0.0227	4.4	2.4	
		BL304WR-BP1		92	55	14	6	480	30.5	30	24.8	0.0227	4.4	2.4	
		BL406WN-BP1		92	55	14	6	480	30.5	30	24.8	0.0227	4.4	2.4	
		BL406WR-BP1		92	55	14	6	480	30.5	30	24.8	0.0227	4.4	2.4	
		BL608WN-BP1		92	55	14	6	480	30.5	30	24.8	0.0227	4.4	2.4	
		BL608WR-BP1		92	55	14	6	480	30.5	30	24.8	0.0227	4.4	2.4	



## Vacuum and Krypton



### Specifications

Model Number	Technology	Amperage	Voltage	Bulb/Socket/ Brightness		Av. Life (Hrs)
BV2/50P-BP2	Vacuum	0.50A	2.4 V	Prefocused/ 0.910	Flange (P13.5S)/	15
BV3/50P-BP2	Vacuum	0.50A	3.6 V	Prefocused/ 1.700	Flange (P13.5S)/	15
BK2/70P-BP2	Krypton	0.70A	2.4 V	Prefocused/ 1.300	Flange (P13.5S)/	20
BK3/50P-BP2	Krypton	0.50A	3.6 V	Prefocused/ 1.200	Flange (P13.5S)/	50
BK3/75P-BP2	Krypton	0.75A	3.6 V	Prefocused/ 2.650	Flange (P13.5S)/	25
BK4/75P-BP2	Krypton	0.75A	4.8 V	Prefocused/ 4.500	Flange (P13.5S)/	25

### Packaging Details

Pack. Picture	Name	Item #	Packaging Type	Blister/Box Details				Outer Carton Details						
				Dimensions (mm)			Net Weight (g)	Packs/ Carton	Dimensions (cm)			Volume (M <sup>3</sup> )	Gross Weight (Kg)	Net Weight (kg)
				L Length	W Width	D Depth			L Length	W Width	D Depth			
	Flashlight Bulbs	BV2/50P-BP2	Blister Pack	114	84	14	10	480	36.5	36.5	34	0.0453	7.0	5.0
		BK2/70P-BP2		114	84	14	10	480	36.5	36.5	34	0.0453	7.0	5.0
		BV3/50P-BP2		114	84	14	10	480	36.5	36.5	34	0.0453	7.0	5.0
		BK3/50P-BP2		114	84	14	10	480	36.5	36.5	34	0.0453	7.0	5.0
		BK3/75P-BP2		114	84	14	10	480	36.5	36.5	34	0.0453	7.0	5.0
		BK4/75P-BP2		114	84	14	10	480	36.5	36.5	34	0.0453	7.0	5.0



## Sales Promotional Material

Maximum Impact, Minimum Space, Optimal Sales

When you want your Camelion products to have maximum impact you need optimal POP promotional material.

For the latest sales accessories and premiums please contact us at info@camelion.com



WCD-02 WCD-03 WCD-05

### Metal Counter Display

- WCD-02: 33x43x22cm (6 hooks)
- WCD-03: 33x58x22cm (9 hooks)
- WCD-05: 44x66x20cm (12 hook)
- Sturdy steel construction for long use
- Easy to see, easy to reach
- Light weight for easy portability
- Available in Metal Black



WCD-06

### Metal Counter Display

- 10 Racks 20 hooks L = 12,5cm
- Simple and lightweight design
- Dimensions: 35(L)x35(W)x160(H)cm

- Qty for Each Hook:**
- AAA Size: 10packs
  - AA Size: 7packs
  - 9V Size: 6packs
  - C Size: 5packs
  - D Size: 4packs



### Metal Counter Display

MFD-02

- Use metal racks to expand each peg
- Professional slim and elegant design
- Rugged steel construction for long life
- Easy assembly by interlocking joints, no screws or hammers (Instructions included)
- W x H x D: 46x70x26cm



### Metal Floor Display

MFD-03

- Up to 300-400 peg holes (ideally holds 20-30 large/medium size packages)
- Use metal racks to expand each peg
- Professional slim and elegant design
- Rugged steel construction for long life
- Easy assembly by interlocking joints, no screws or hammers (Instructions included)
- W x H x D: 180 x 34 x 60,5cm



### Metal Floor Display

MFD-04

- 6 Height-adjustable racks
- 2 Basket racks (L=10cm)
- Easily add racks
- Dimensions: 67(L)x36(W)x175(H)cm

- Qty for Each Hook:**
- AAA Size: 10packs
  - AA Size: 7packs
  - 9V Size: 6packs
  - C Size: 5packs
  - D Size: 4packs



### Metal Floor Display

MFD-05

- Durable furnace-tested metal finish
- 72 hooks are included
- 8 Basket racks (L=10cm)
- 4 Face/360 Degree Rotatable Design
- Easily add racks
- Dimensions: 48 x 48 x 151cm

- Qty for Each Hook:**
- AAA Size: 10packs
  - AA Size: 7packs
  - 9V Size: 6packs
  - C Size: 5packs
  - D Size: 4packs



HW-01



HW-04



HW-05



HW-06

### 4 Metal Hook Racks

- HW-01
- W x H x D: 10x75x8cm

### 12 Clear Plastic Hook Racks

- HW-04
- W x H: 7.5x62cm

### 12 White Plastic Hook Racks

- HW-05
- W x H: 6.2x77.5cm

### 12 Black Plastic Hook Racks

- HW-06
- W x H: 84x11.3cm



### Aisle Display Box

DR-05

The new display rack is designed to make items easier to reach and retrieve. You can order different kinds of batteries according to your sales. It is easy for transportation and set up in the store and supermarket. It also uses some new branding elements like Mr Camelion.

- Use of informative images
- Clear Branding
- Light, durable materials
- Easy to place and retrieve items
- Clear Messages
- W x H x D: 36.5x137x44cm



DR-06-SHD DR-06-A

### Aisle Display Box

Economical corrugated cardboard retail displays are great for presentations and trade shows. This portable display is lightweight, easy to set up for high retail display traffic.

- Freestanding cardboard POP display has 20 trays, each tray is 9.5cm wide x 11.8cm high x 13cm deep.
- W x H x D: 41.5x138.2x32.5cm



### Aisle Display Box

DR-07

Economical corrugated cardboard retail displays are great for presentations and trade shows. This portable display is lightweight, easy to set up for high retail display traffic.

- Freestanding cardboard POP display has 30 trays, rechargeables each tray is 9.5cm wide x 18.7cm high x 15.8cm deep.
- batteries each tray is 9.5cm wide x 13.2cm high x 15.8cm deep.
- W x H x D: 52.3x150x31.5cm



### Cardboard Floor Display

DR-08

Economical portable cardboard retail display is great for presentation in store, supermarket, road show and exhibition. It is easy for set up and transportation as well as hit high retail display traffic.

- Freestanding cardboard floor display has 20 trays, each tray is 12.0cm(W) x 20.3cm (H) x 30.8cm(D).
- W x H x D: 52x150x47cm.



SPK-01 SPK-02

### Desktop Acrylic Display Stand

ADS-01

- Compact Size suitable on the shelf or near the cashier
- 15 Flexible hooks for different series of products (hook: L=5cm)
- Dimensions (L\*W\*H mm): 490\*350\*130(\*8 Depth) 75°
- Elegant design : Economical and versatile
- Durable and light : Made by acrylic material

### Six Options:



DR-11 DR-12

### Battery Aisle Display Box

- Battery shaped floorstand trigger and strengthen brand recognition
- Brand space maximized through strong printed graphics
- Strong structural integrity for easy moving
- Ideal for most retail markets placement
- DR-11: 160x65cm.
- DR-12: 70x32cm.



T-05WR T-05WB

### Short-sleeved T-Shirt

- Durable cotton matt short sleeved polo style shirt
- Cotton matt





**Caps**

**C-01**

Comfortable golf caps with all-size fits design, in trendy corporate colors.



**Wristband**

**WB-01**



**Non Woven Fiber**

**HB-03**



**Non Woven Bag**

**HB-04**

- Material: fiber
- W x H x D: 38x34x10cm



**Plastic**

**HB-05**

- W x H x D: 30x38x6cm



**Promotional Tote Bag**

**HB-06**

- Material: fiber
- W x H x D: 38x34x12cm



**Balloon Pop Up**

**AIRB-01**



**Promotion Bag**

(Transparent)

**PTB-01**

- W x H : 13x20cm



**Ball pen**

**PAN-01**



**Gel Pen with Rubber Coated**

**PAN-02**



**Memo Post It**

- W x H: 41.5 x 58 cm

**PB-03**

**PB-04**

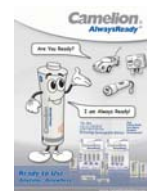

**AlwaysReady Poster**

**POSTER-AR**

- W x H: 41.5x58cm



**Notebook**

**PM-07G**

- Spiral bound
- Durable plastic front and back
- Includes 6 Page color product brochure
- W x H: 17x19cm



**AlwaysReady Leaflet**

**LFLT-AR**

- LEFL-AlwaysReady
- W x H: 14x21cm



**Posters**

Our sales literature and marketing materials are created to bring out the benefits of Camelion products.

- Professionally produced and designed
- Simple and powerful messages
- Useful information
- Designed with the end-user in mind
- W x H: 39x57cm



**X Banner Stand**

Available : Charger and Battery banners

- W x H: 80x180cm



**Retractable Roll Up Banner Stand**

Available : Charger and Battery banners

- W x H: 80x200cm



**Supermarket Banner**

Model: SMB-LI/SMB-DA/SMB-PA/SMB-AR/SMB-NH

- This banner is suitable for Supermarkets, retail stores, malls, etc.
- It is excellent advertisement for Camelion Brand.
- W x H: 45 x 60 cm



**Floor Sticker**

Model: FG-LI/FG-DA/FG-PA/FG-AR/FG-NH

- The floor sticker is abrasion resistance and durable.
- Can be used in the lobby, supermarket's aisles, shopping malls, or any public place.
- W x H: 150 x 110 cm, 110 x 80 cm, 80 x 60 cm



**Step Stickers**

- This announcement can be used in the steps of supermarkets, shopping malls and many other places.
- W x H: 200 x 16 cm