

# A3 Series FREE POWER PHOTO SENSOR

- \* Extensive operating voltage  
DC 12~240V or AC 24~240V
  - \* High capacity relay output 3A/250VAC
  - \* High compact structure IP-66
  - \* Multi surge killer circuit effectively protects from surge damage
  - \* B type ( Normal close type )  
have no stock maybe ,  
accepted order to manufacture
- Model : A3R-30XB , A3R-1MXB , A3R-2MXB  
A3G-2MRB , A3G-4MXB  
A3T-10MXB , A3T-20MXB

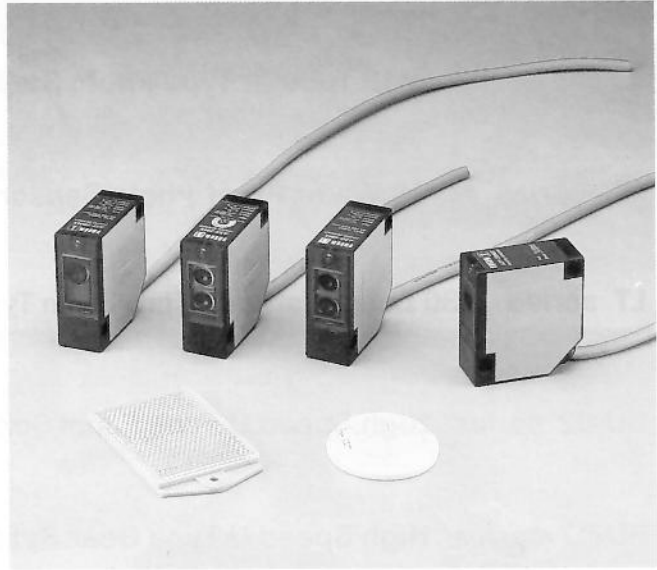

## General Specification

Specification	Data
Operating Voltage	12~240 VDC ; 24~240 VAC , 50/60HZ
Current Consumption	2VA max.
Output Method	Relay
Contact Current	3A/250 VAC
Response Time	15ms
Illumination	Lamplight < 10,000 Lux. ; Sunlight < 30,000 Lux.
Connection Method	5 Cores / 6.0 $\varphi$ X 2m
Noise Resistance	1500Vp - p/1 $\mu$ s
Surge Resistance	2 KV/1 $\mu$ S
Vibration Resistance	10~55Hz / 1.5mm , 2 Hour In X.Y.Z. Direction
Housing Material	Case : Intensive ABS ; Lens : PC
Operating Temp./Hum.	-20°C ~ +60°C ; 35% ~ 85% RH

Connection Diagram

Connection diagram

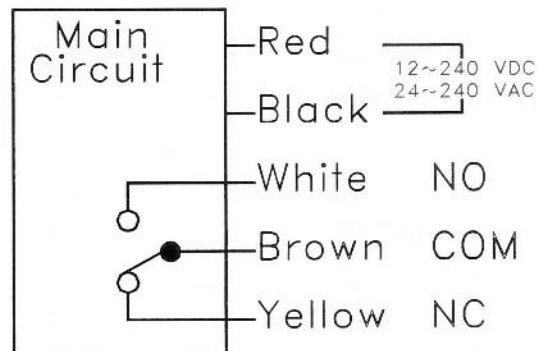

## ■ Reflex Type

Type	Standard Type			Water-Proof Type		
Model	A3R-30X	A3R-1MX	A3R-2MX	A3R-30XP	A3R-1MXP	A3R-2MXP
Sensing Distance	30cm	100cm	200cm	30cm	100cm	200cm
Protection Class	IP-65			IP-67		
Operating Voltage	12~240 VDC ; 24~240 VAC 50/60Hz					
Output Method	Relay					
Output Status	NO. <Received ON >					
Sensitivity Adjuster	270° Trimmer					
Emitter	Infrared LED					
Min. Sensible Object	5.0φ					
Weight	Appr.145g			Appr.155g		

## ■ Mirror Reflex Type

Type	Standard Type			Water-Proof Type	
Model	A3G-2MR	A3G-2MRS	A3G-4MX	A3G-2MRP	A3G-4MXP
Sensing Distance	3m	2m	4m	3m	4.5m
Emitter	Red LED	Red LED	Infrared LED	Red LED	Infrared LED
Sensing Adjuster	Trimmer	Without		Trimmer	Without
Protect Class	IP-65			IP-67	
Operating Voltage	12~240 VDC ; 24~240 VAC 50/60Hz				
Output Method	Relay				
Output Status	NO. < Break ON >				
Min. Sensible Object	2.0φ	5.0φ		2.0φ	5.0φ
Weight	Appr.145g			Appr.155g	

## ■ Thru Beam Type

Type	Standard Type			Water-Proof Type		
Model	A3T-3MX	A3T-10MX	A3T-20MX	A3T-3MXP	A3T-10MXP	A3T-20MXP
Sensing Distance	3m	10m	20m	3m	10m	20m
Protection Class	IP-65			IP-67		
Operating Voltage	12~240 VDC ; 24~240 VAC 50/60Hz					
Output Method	Relay					
Output Status	NO. < Break ON >					
Emitter	Infrared LED					
Sensitivity Adjuster	Without					
Min. Sensible Object	2.0φ	5.0φ	10.0φ	2.0φ	5.0φ	10.0φ
Weight	Appr.285g			Appr.305g		

# A3 Series FREE POWER PHOTO SENSOR

## Characteristic Curve < Typical >

Diffuse Reflex type

A3R-1MX

Sensing area

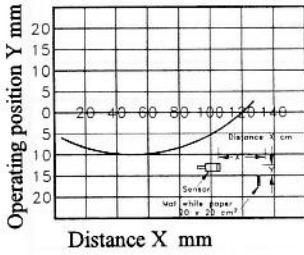

Mirror Reflex type

A3G-2MR/A3G-4MX

Setting range

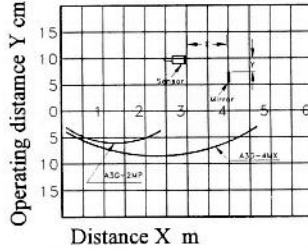

Thru Beam type

A3T-10MX/A3T-20MX

Setting range

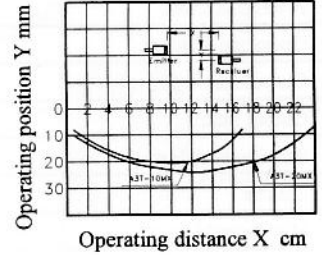

Sensing area

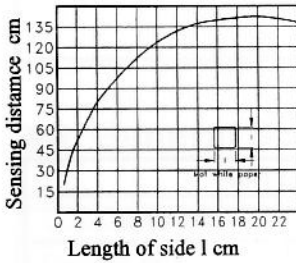

Setting angle

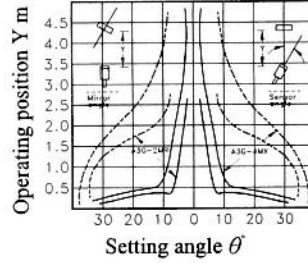

Setting angle

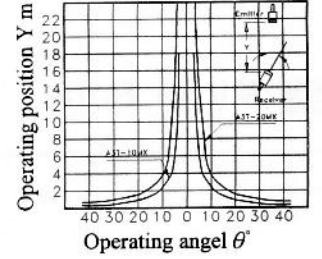

## Dimension

