

DC Fan



92x92x32 mm

San Ace 92 9G type

General Specifications

- Material Frame: Plastic (Flammability: UL 94V-0), Impeller: Plastic (Flammability: UL 94V-1)
- Expected life See the table below. (L10 life: 90% survival rate for continuous operation in free air at 60°C, rated voltage)
Expected life at 40°C is for reference only.
- Motor protection function Locked rotor burnout protection, Reverse polarity protection
For details, please refer to p. 573.
- Dielectric strength 50/60 Hz, 500 VAC, for 1 minute (between lead wire conductors and frame)
- Insulation resistance 10 MΩ or more with a 500 VDC megger (between lead wire conductors and frame)
- Sound pressure level (SPL) At 1 m away from the air inlet
- Storage temperature -30 to +70°C (Non-condensing)
- Lead wire ⊕Red ⊖Black or Blue Sensor Yellow
- Mass 170 g

Specifications

The models listed below **have ribs and pulse sensors**. For models without ribs, append "1" to the end of model numbers.

Model no.	Rated voltage [V]	Operating voltage range [V]	Rated current [A]	Rated input [W]	Rated speed [min ⁻¹]	Max. airflow [m ³ /min] [CFM]	Max. static pressure [Pa] [inchH ₂ O]	SPL [dB (A)]	Operating temperature [°C]	Expected life [h]
9G0912A201	12	10.2 to 13.8	0.58	6.96	4300	2.5 88.3	115 0.462	44	-20 to +70	40000/60°C (70000/40°C)
9G0912S201			0.38	4.56	3500	2.0 70.7	77 0.309	38		
9G0912H201			0.23	2.76	2850	1.59 56.2	51 0.205	32		
9G0912M201			0.13	1.56	2100	1.2 42.4	27 0.108	25		
9G0924A201	24	20.4 to 27.6	0.3	7.2	4300	2.5 88.3	115 0.462	44	-20 to +60	
9G0924S201			0.19	4.56	3500	2.0 70.7	77 0.309	38		
9G0924H201			0.12	2.88	2850	1.59 56.2	51 0.205	32		
9G0924M201			0.08	1.92	2100	1.2 42.4	27 0.108	25		
9G0948A201	48	40.8 to 55.2	0.16	7.68	4300	2.5 88.3	115 0.462	44	-20 to +70	
9G0948S201			0.11	5.28	3500	2.0 70.7	77 0.309	38		
9G0948H201			0.08	3.84	2850	1.59 56.2	51 0.205	32		
9G0948M201			0.05	2.4	2100	1.2 42.4	27 0.108	25		

The following sensor and control options are available for selection.

Available for all models. Without sensor Lock sensor

Differs according to the model. Refer to the table on pp. 600 to 601. PWM control

The ☞ mark indicates Short LeadTime Service applicable models. See p. 626 for details.

Airflow - Static Pressure Characteristics

9G0912A201 With pulse sensor

Operating voltage range

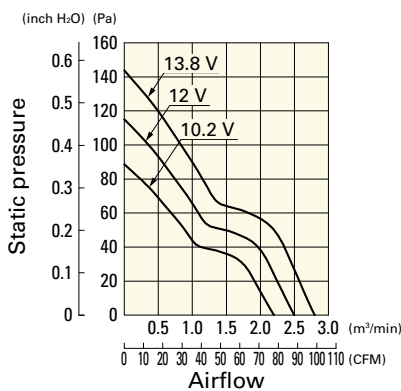

9G0912S201 With pulse sensor

Operating voltage range

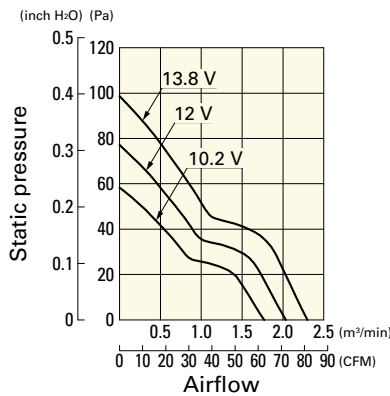

9G0912H201 With pulse sensor

Operating voltage range

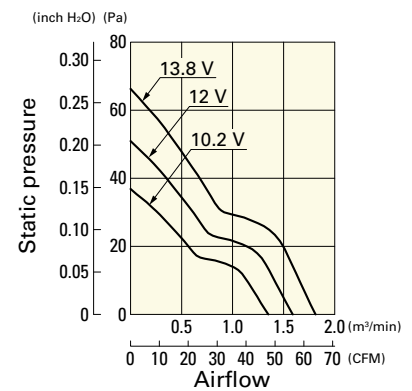

Airflow - Static Pressure Characteristics

9G0912M201 With pulse sensor

Operating voltage range

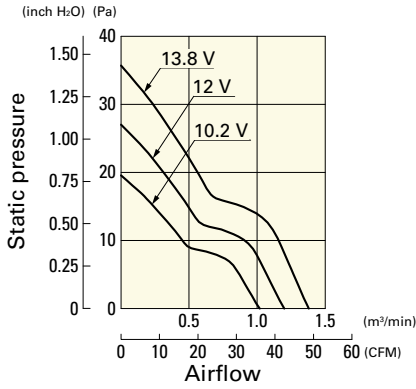

9G0924A201 With pulse sensor

Operating voltage range

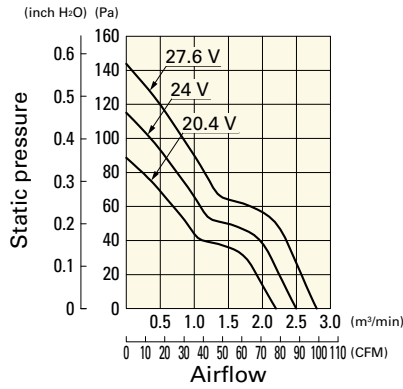

9G0924S201 With pulse sensor

Operating voltage range

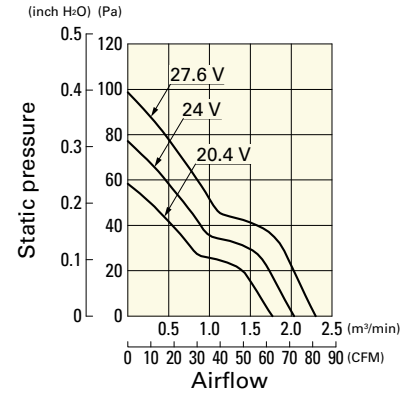

9G0924H201 With pulse sensor

Operating voltage range

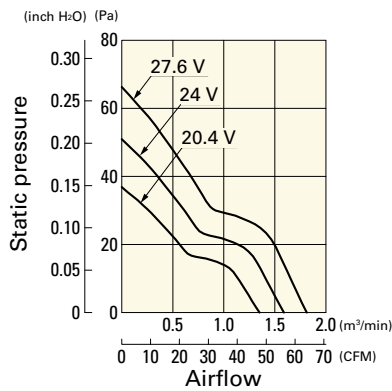

9G0924M201 With pulse sensor

Operating voltage range

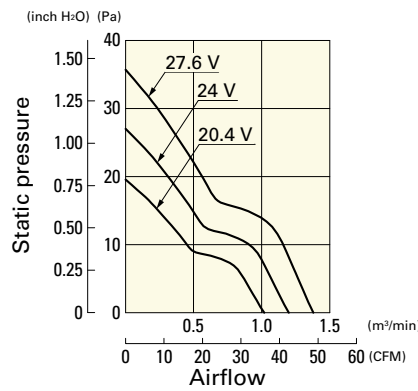

9G0948A201 With pulse sensor

Operating voltage range

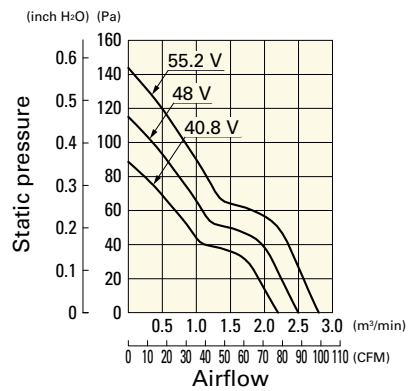

9G0948S201 With pulse sensor

Operating voltage range

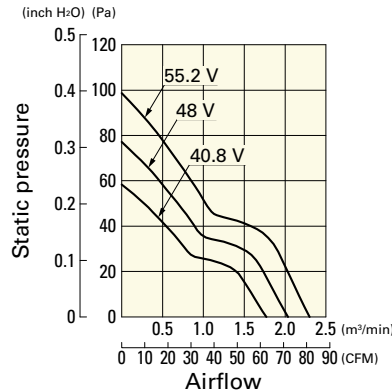

9G0948H201 With pulse sensor

Operating voltage range

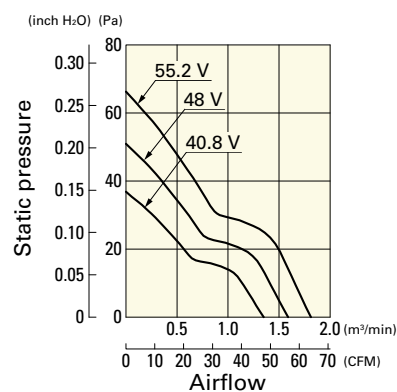

9G0948M201 With pulse sensor

Operating voltage range

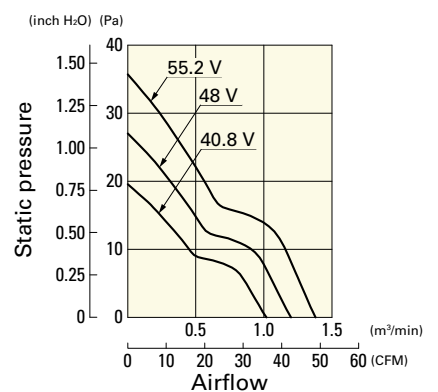

Dimensions (unit: mm) (With ribs)

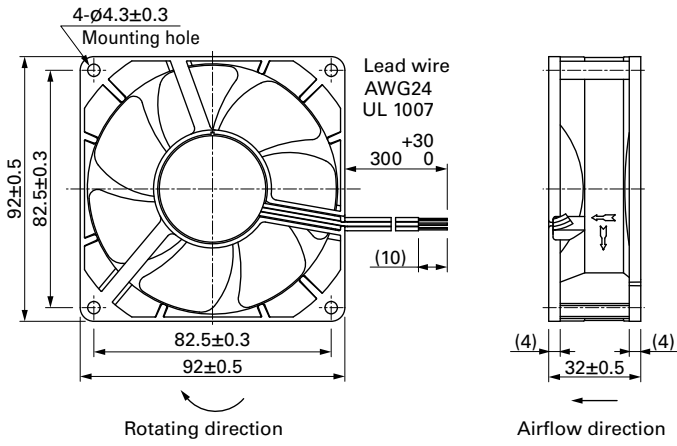

Reference Dimensions of Mounting Holes and Vent Opening (unit: mm)

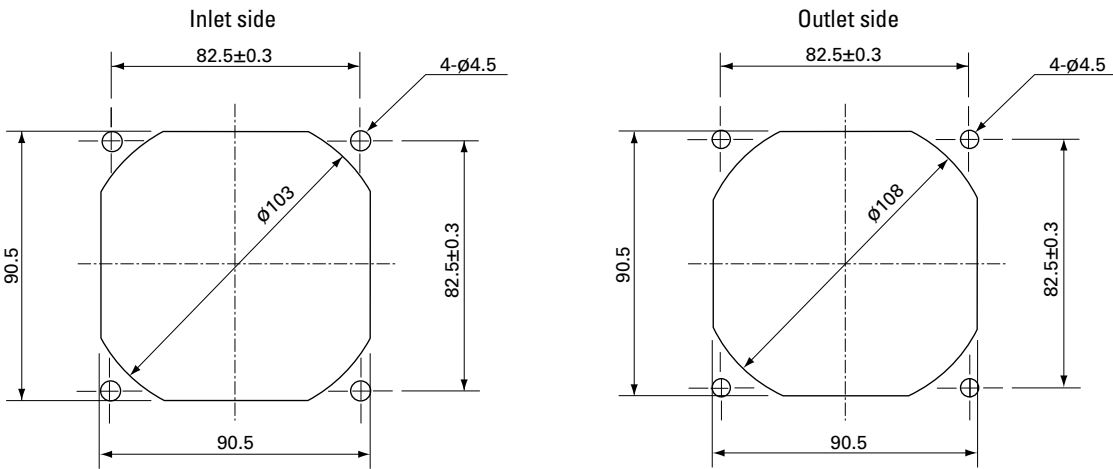

Options

Finger guards page: p. 558
Model no.: 109-099E, 109-099H, 109-099C

Resin finger guards page: p. 565
Model no.: 109-1001G

Resin filter kits page: p. 566
Model no.: 109-1001F13 (13PPI), 109-1001F20 (20PPI),
109-1001F30 (30PPI), 109-1001F40 (40PPI)